



ON Semiconductor®

December 2017

FFB2222A / FMB2222A / MMPQ2222A NPN Multi-Chip General-Purpose Amplifier

Description

This device is for use as a medium power amplifier and switch requiring collector currents up to 500 mA. Sourced from process 19.

Block Diagram

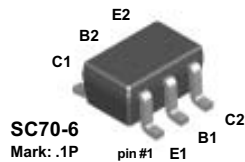

The pinouts are symmetrical; pin 1 and pin 4 are interchangeable. Units inside the carrier tape can be of either orientation (0 deg and 180 deg) and will not affect the functionality of the device.

Figure 1. FFB2222A Device Package

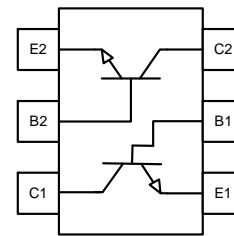

Figure 2. FFB2222A Internal Connection

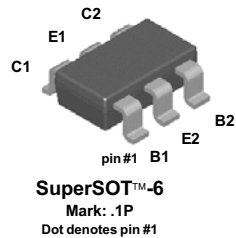

Figure 3. FMB2222A Device Package

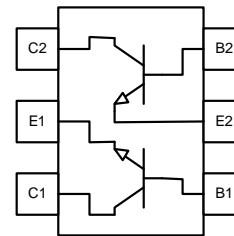

Figure 4. FMB2222A Internal Connection

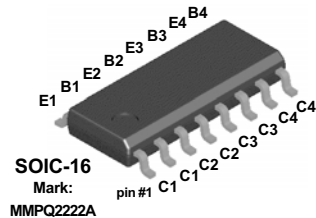

Figure 5. MMPQ2222A Device Package

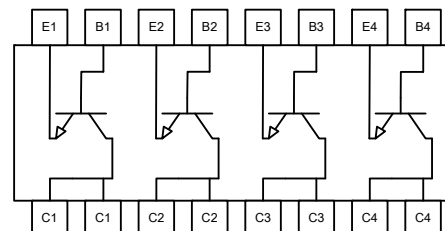

Figure 6. MMPQ2222A Internal Connection

FFB2222A / FMB2222A / MMPQ2222A — NPN Multi-Chip General-Purpose Amplifier

Ordering Information

Part Number	Top Mark	Package	Packing Method
FFB2222A	.1P	SC70 6L	Tape and Reel
FMB2222A	.1P	SSOT 6L	Tape and Reel
MMPQ2222A	MMPQ2222A	SOIC 16L	Tape and Reel

Absolute Maximum Ratings⁽¹⁾

Stresses exceeding the absolute maximum ratings may damage the device. The device may not function or be operable above the recommended operating conditions and stressing the parts to these levels is not recommended. In addition, extended exposure to stresses above the recommended operating conditions may affect device reliability. The absolute maximum ratings are stress ratings only. Values are at $T_A = 25^\circ\text{C}$ unless otherwise noted.

Symbol	Parameter	Value	Unit
V_{CEO}	Collector-Emitter Voltage	45	V
V_{CBO}	Collector-Base Voltage	75	V
V_{EBO}	Emitter-Base Voltage	5.0	V
I_C	Collector Current - Continuous	500	mA
T_J, T_{STG}	Operating and Storage Junction Temperature Range	-55 to +150	$^\circ\text{C}$

Note:

- These ratings are based on a maximum junction temperature of 150°C . These are steady-state limits. Fairchild Semiconductor should be consulted on applications involving pulsed or low-duty cycle operations.

Thermal Characteristics⁽²⁾

Values are at $T_A = 25^\circ\text{C}$ unless otherwise noted.

Symbol	Parameter	Max.			Unit
		FFB2222A	FMB2222A	MMPQ2222A	
P_D	Total Device Dissipation	300	700	1,000	mW
	Derate Above 25°C	2.4	5.6	8.0	mW/ $^\circ\text{C}$
$R_{\theta JA}$	Thermal Resistance, Junction-to-Ambient	415	180		$^\circ\text{C}/\text{W}$
	Thermal Resistance, Junction-to-Ambient, Effective 4 Dies			125	
	Thermal Resistance, Junction-to-Ambient, Each Die			240	

Note:

- PCB size: FR-4, 76 mm x 114 mm x 1.57 mm (3.0 inch x 4.5 inch x 0.062 inch) with minimum land pattern size.

Electrical Characteristics

Values are at $T_A = 25^\circ\text{C}$ unless otherwise noted.

Symbol	Parameter	Conditions	Min.	Typ.	Max.	Unit
$V_{(BR)CEO}$	Collector-Emitter Breakdown Voltage ⁽³⁾	$I_C = 10\text{ mA}, I_B = 0$	40			V
$V_{(BR)CBO}$	Collector-Base Breakdown Voltage	$I_C = 10\text{ }\mu\text{A}, I_E = 0$	75			V
$V_{(BR)EBO}$	Emitter-Base Breakdown Voltage	$I_E = 10\text{ }\mu\text{A}, I_C = 0$	5.0			V
I_{CBO}	Collector Cut-Off Current	$V_{CB} = 60\text{ V}, I_E = 0$			10	nA
I_{EBO}	Emitter Cut-Off Current	$V_{EB} = 3.0\text{ V}, I_C = 0$			10	nA
h_{FE}	DC Current Gain	$I_C = 0.1\text{ mA}, V_{CE} = 10\text{ V}$	35			
		$I_C = 1.0\text{ mA}, V_{CE} = 10\text{ V}$	50			
		$I_C = 10\text{ mA}, V_{CE} = 10\text{ V}$	75			
		$I_C = 150\text{ mA}, V_{CE} = 10\text{ V}^{(3)}$	100		300	
		$I_C = 150\text{ mA}, V_{CE} = 1.0\text{ V}^{(3)}$	50			
		$I_C = 500\text{ mA}, V_{CE} = 10\text{ V}^{(3)}$	40			
$V_{CE(sat)}$	Collector-Emitter Saturation Voltage ⁽³⁾	$I_C = 150\text{ mA}, I_B = 15\text{ mA}$			0.3	V
		$I_C = 500\text{ mA}, I_B = 50\text{ mA}$			1.0	
$V_{BE(sat)}$	Base-Emitter Saturation Voltage ⁽³⁾	$I_C = 150\text{ mA}, I_B = 15\text{ mA}$			1.2	V
		$I_C = 500\text{ mA}, I_B = 50\text{ mA}$			2.0	
f_T	Current Gain - Bandwidth Product	$I_C = 20\text{ mA}, V_{CE} = 20\text{ V},$ $f = 100\text{ MHz}$		300		MHz
C_{obo}	Output Capacitance	$V_{CB} = 10\text{ V}, I_E = 0,$ $f = 100\text{ kHz}$		4.0		pF
C_{ibo}	Input Capacitance	$V_{EB} = 0.5\text{ V}, I_C = 0,$ $f = 100\text{ kHz}$		20		pF
NF	Noise Figure	$I_C = 100\text{ }\mu\text{A}, V_{CE} = 10\text{ V},$ $R_S = 1.0\text{ k}\Omega, f = 1.0\text{ kHz}$		2.0		dB
t_d	Delay Time	$V_{CC} = 30\text{ V}, V_{BE(OFF)} = 0.5\text{ V},$ $I_C = 150\text{ mA}, I_{B1} = 15\text{ mA}$		8		ns
t_r	Rise Time			20		ns
t_s	Storage Time	$V_{CC} = 30\text{ V}, I_C = 150\text{ mA},$ $I_{B1} = I_{B2} = 15\text{ mA}$		180		ns
t_f	Fall Time			40		ns

Note:

3. Pulse test: pulse width $\leq 300\text{ }\mu\text{s}$, duty cycle $\leq 2.0\%$.

Typical Performance Characteristics

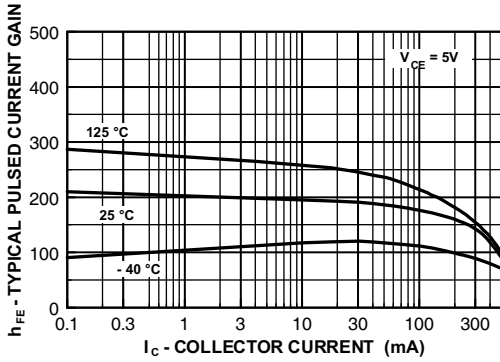

Figure 7. Typical Pulsed Current Gain vs. Collector Current

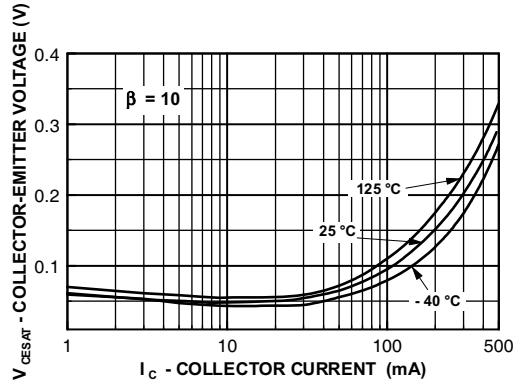

Figure 8. Collector-Emitter Saturation Voltage vs. Collector Current

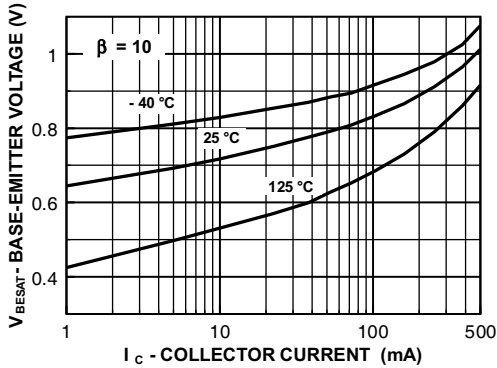

Figure 9. Base-Emitter Saturation Voltage vs. Collector Current

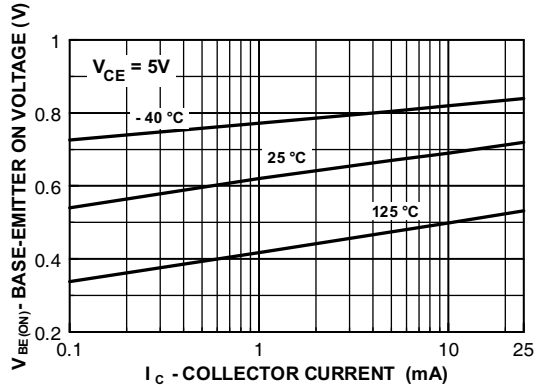

Figure 10. Base-Emitter On Voltage vs. Collector Current

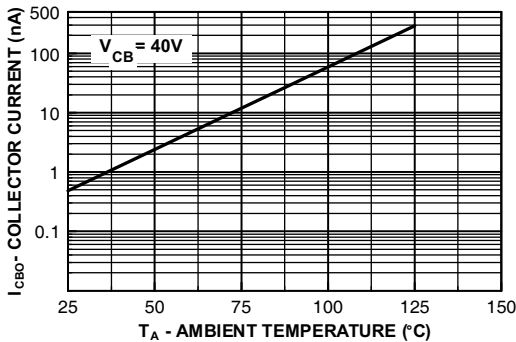

Figure 11. Collector Cut-Off Current vs. Ambient Temperature

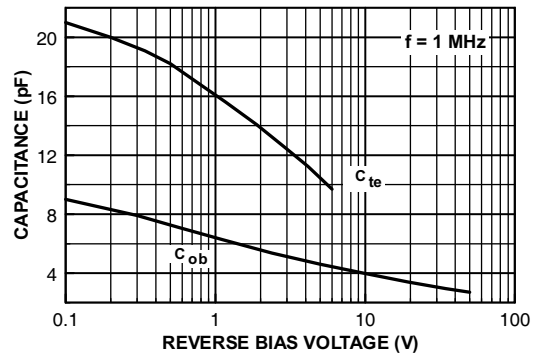

Figure 12. Emitter Transition and Output Capacitance vs. Reverse Bias Voltage

Typical Performance Characteristics (Continued)

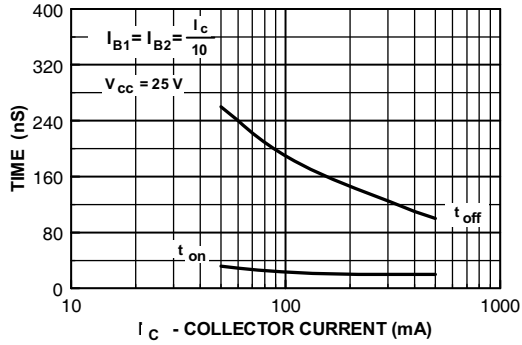

Figure 13. Turn-On and Turn-Off Times vs. Collector Current

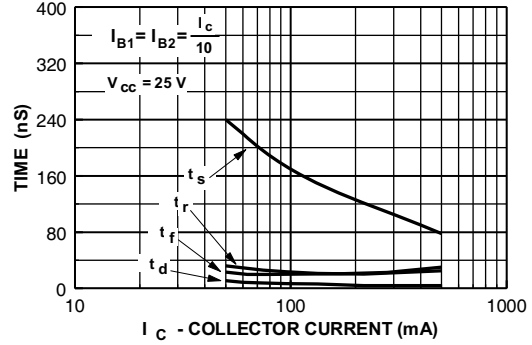

Figure 14. Switching Time vs. Collector Current

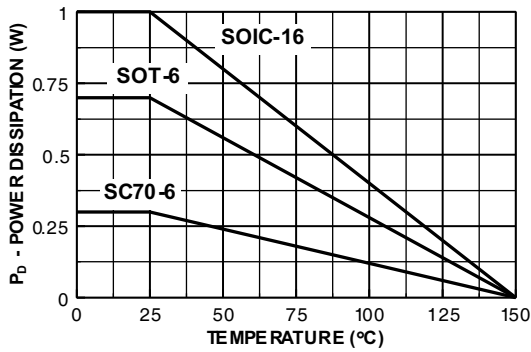

Figure 15. Power Dissipation vs. Ambient Temperature

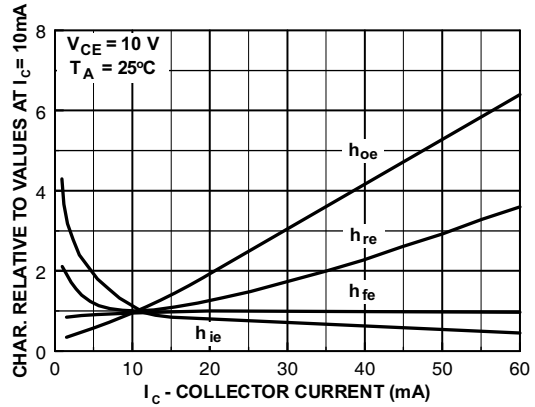

Figure 16. Common Emitter Characteristics

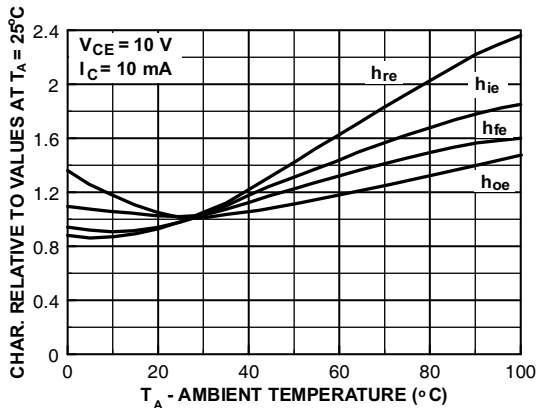

Figure 17. Common Emitter Characteristics

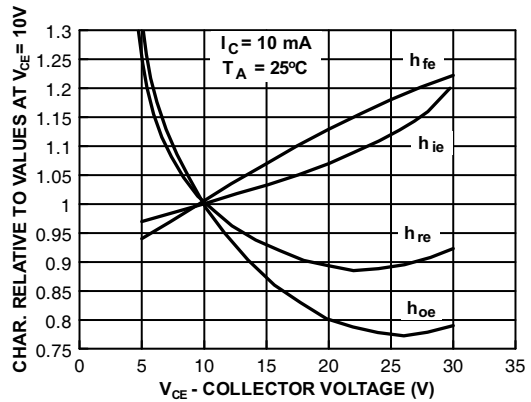

Figure 18. Common Emitter Characteristics

Test Circuits

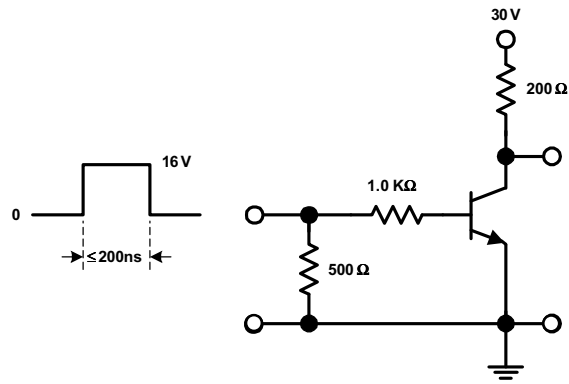

Figure 19. Saturated Turn-On Switching Time

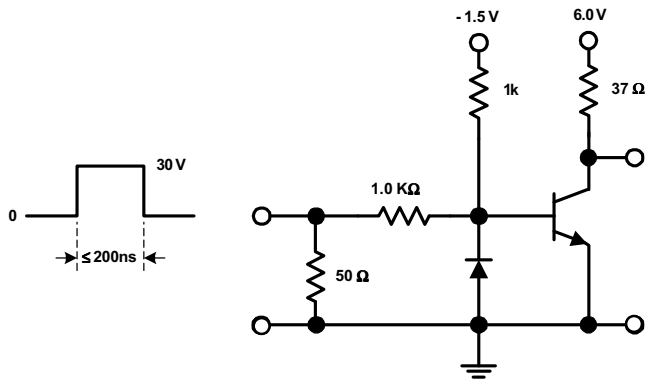
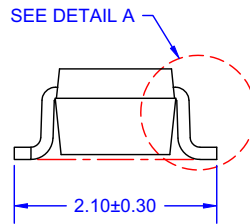
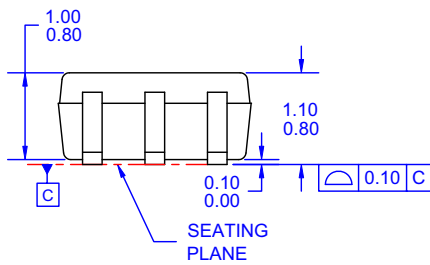
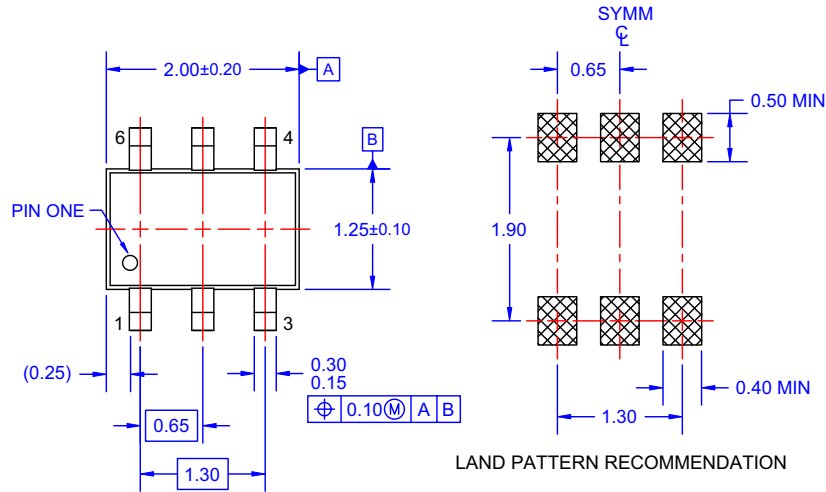

Figure 20. Saturated Turn-Off Switching Time

Physical Dimensions

SC70 6L



NOTES: UNLESS OTHERWISE SPECIFIED

- A) THIS PACKAGE CONFORMS TO EIAJ SC-88, 1996.
- B) ALL DIMENSIONS ARE IN MILLIMETERS.
- C) DIMENSIONS DO NOT INCLUDE BURRS OR MOLD FLASH.
- D) DRAWING FILENAME: MKT-MAA06AREV6

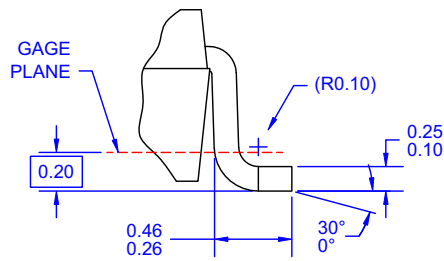

DETAIL A
SCALE: 60X

Figure 25. 6-LEAD, SC70, EIAJ SC-88, 1.25 MM WIDE (ACTIVE)

Physical Dimensions (Continued)

SSOT 6L

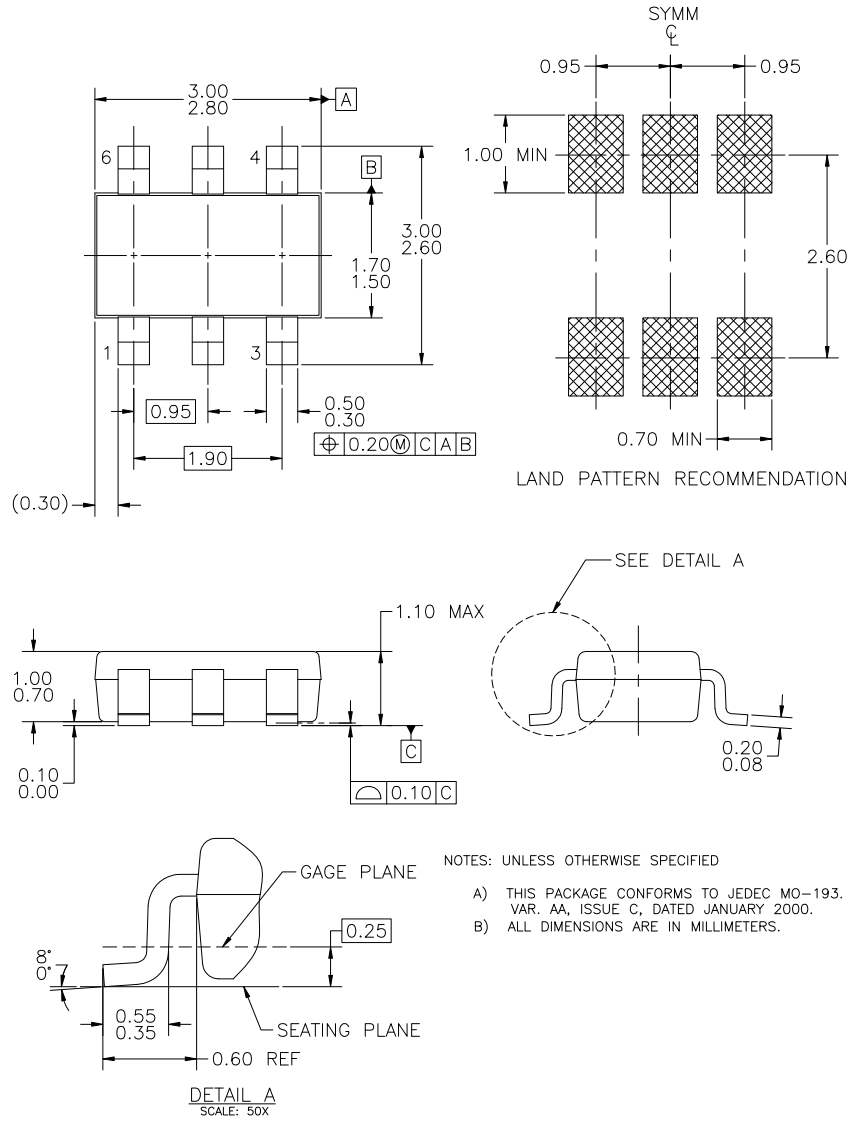

Figure 26. 6-LEAD, SUPERSOT-6, JEDEC MO-193, 1.6 MM WIDE (ACTIVE)

Physical Dimensions (Continued)

SO 16L NB

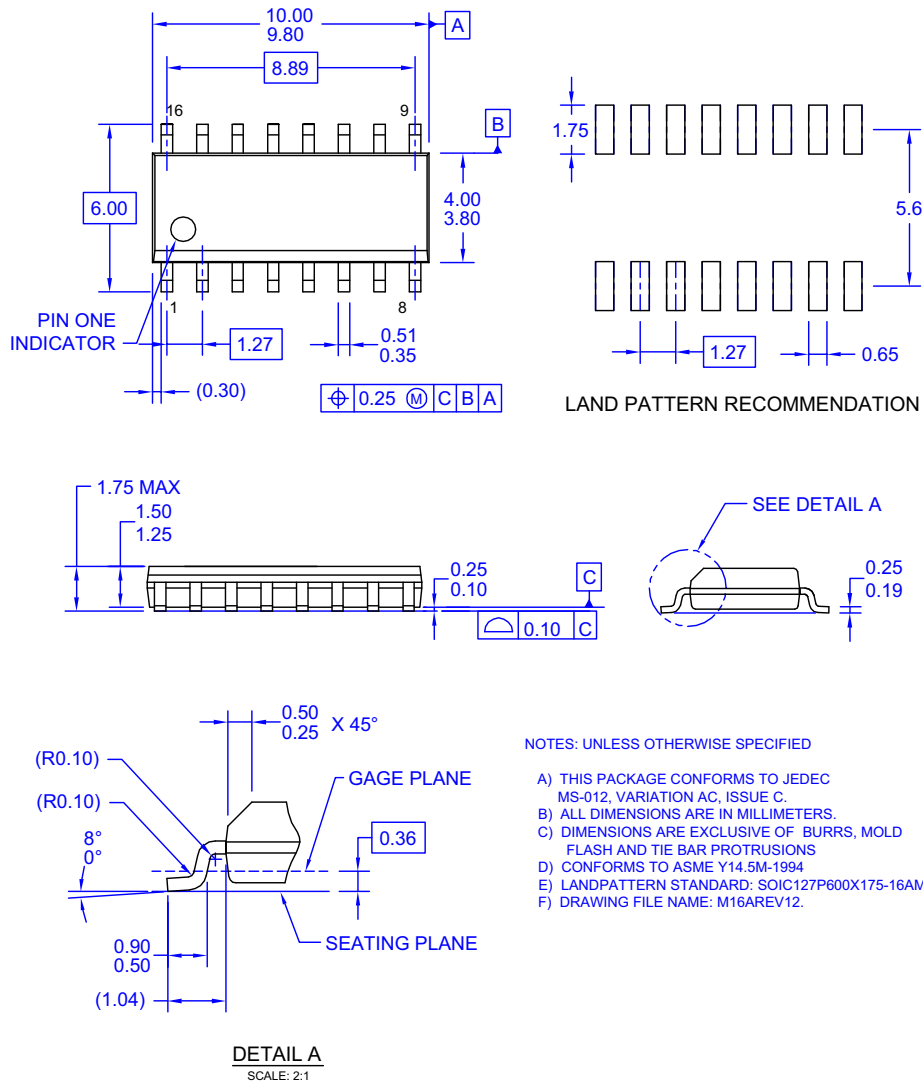



Figure 27. 16-LEAD, SOIC, JEDEC MS-012, 0.150 inch, NARROW BODY (ACTIVE)

ON Semiconductor and  are trademarks of Semiconductor Components Industries, LLC dba ON Semiconductor or its subsidiaries in the United States and/or other countries. ON Semiconductor owns the rights to a number of patents, trademarks, copyrights, trade secrets, and other intellectual property. A listing of ON Semiconductor's product/patent coverage may be accessed at www.onsemi.com/site/pdf/Patent-Marking.pdf. ON Semiconductor reserves the right to make changes without further notice to any products herein. ON Semiconductor makes no warranty, representation or guarantee regarding the suitability of its products for any particular purpose, nor does ON Semiconductor assume any liability arising out of the application or use of any product or circuit, and specifically disclaims any and all liability, including without limitation special, consequential or incidental damages. Buyer is responsible for its products and applications using ON Semiconductor products, including compliance with all laws, regulations and safety requirements or standards, regardless of any support or applications information provided by ON Semiconductor. "Typical" parameters which may be provided in ON Semiconductor data sheets and/or specifications can and do vary in different applications and actual performance may vary over time. All operating parameters, including "Typicals" must be validated for each customer application by customer's technical experts. ON Semiconductor does not convey any license under its patent rights nor the rights of others. ON Semiconductor products are not designed, intended, or authorized for use as a critical component in life support systems or any FDA Class 3 medical devices or medical devices with a same or similar classification in a foreign jurisdiction or any devices intended for implantation in the human body. Should Buyer purchase or use ON Semiconductor products for any such unintended or unauthorized application, Buyer shall indemnify and hold ON Semiconductor and its officers, employees, subsidiaries, affiliates, and distributors harmless against all claims, costs, damages, and expenses, and reasonable attorney fees arising out of, directly or indirectly, any claim of personal injury or death associated with such unintended or unauthorized use, even if such claim alleges that ON Semiconductor was negligent regarding the design or manufacture of the part. ON Semiconductor is an Equal Opportunity/Affirmative Action Employer. This literature is subject to all applicable copyright laws and is not for resale in any manner.

PUBLICATION ORDERING INFORMATION

LITERATURE FULFILLMENT:

Literature Distribution Center for ON Semiconductor
19521 E. 32nd Pkwy, Aurora, Colorado 80011 USA
Phone: 303-675-2175 or 800-344-3860 Toll Free USA/Canada
Fax: 303-675-2176 or 800-344-3867 Toll Free USA/Canada
Email: orderlit@onsemi.com

N. American Technical Support: 800-282-9855 Toll Free
USA/Canada
Europe, Middle East and Africa Technical Support:
Phone: 421 33 790 2910
Japan Customer Focus Center
Phone: 81-3-5817-1050

ON Semiconductor Website: www.onsemi.com
Order Literature: <http://www.onsemi.com/orderlit>
For additional information, please contact your local
Sales Representative