

# High Efficiency, Main Power Supply Controllers for Notebook Computers

## General Description

The RT8206A/B dual step-down, Switch Mode Power Supply (SMPS) controller generates logic supply voltages in battery powered systems. The RT8206A/B includes two Pulse Width Modulation (PWM) controllers fixed at 5V/3.3V or adjustable from 2V to 5.5V. An optional external charge pump can be monitored through SECFB (RT8206A). This device also features a linear regulator providing a fixed 5V output. The linear regulator provides up to 70mA output current with automatic linear regulator bootstrapping to the BYP input. The RT8206A/B includes on-board power up sequencing, the power good outputs, internal soft-start, and internal soft-discharge output that prevents negative voltages on shutdown.

A constant on-time PWM control scheme operates without sense resistors and provides 100ns response to load transients while maintaining a relatively constant switching frequency. The unique ultrasonic mode maintains the switching frequency above 25kHz, which eliminates noise in audio applications. Other features include Diode Emulation Mode (DEM), which maximizes efficiency in light load applications, and fixed frequency PWM mode, which reduces RF interference in sensitive application.

The RT8206A/B is available in the WQFN-32L 5x5 package.

## Ordering Information

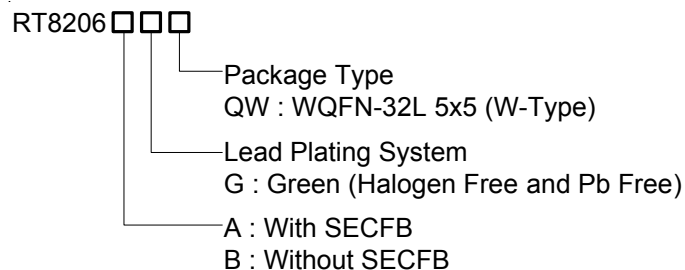

Note :

Richtek products are :

- ▶ RoHS compliant and compatible with the current requirements of IPC/JEDEC J-STD-020.
- ▶ Suitable for use in SnPb or Pb-free soldering processes.

## Features

- Wide Input Voltage Range 6V to 25V
- Dual Fixed 5V/3.3V Outputs or Adjustable from 2V to 5.5V, 1.5% Accuracy
- Secondary Feedback Input Maintains Charge Pump Voltage (RT8206A)
- Independent Enable and Power Good
- 5V Fixed LDO Output : 70mA
- 2V Reference Voltage  $\pm 1\%$  : 50 $\mu$ A
- Constant ON-Time Control with 100ns Load Step Response
- Frequency Selectable via TON Setting
- $R_{DS(ON)}$  Current Sensing and Programmable Current Limit
- Selectable PWM, DEM or Ultrasonic Mode
- Internal Soft-Start with 5 Steps Current Limiting and Soft-Discharge
- High Efficiency Up to 97%
- 5mW Quiescent Power Dissipation
- Thermal Shutdown
- RoHS Compliant and Halogen Free

## Applications

- Notebook and Sub-Notebook Computers
- 3-Cell and 4-Cell Li+ Battery-Powered Devices

## Marking Information

RT8206AGQW

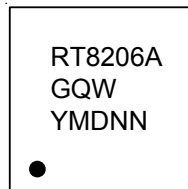

RT8206AGQW : Product Number  
YMDNN : Date Code

RT8206BGQW

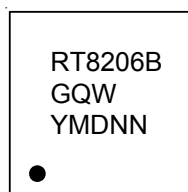

RT8206BGQW : Product Number  
YMDNN : Date Code

## Pin Configurations

(TOP VIEW)

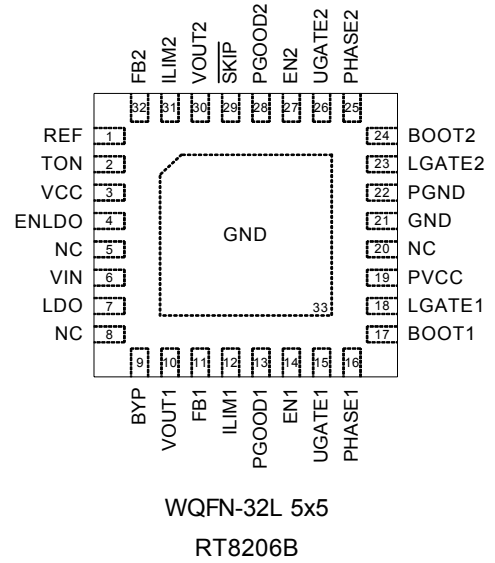
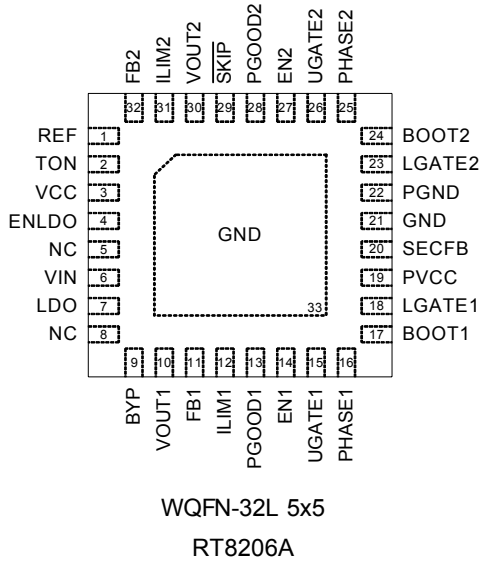

## Typical Application Circuit

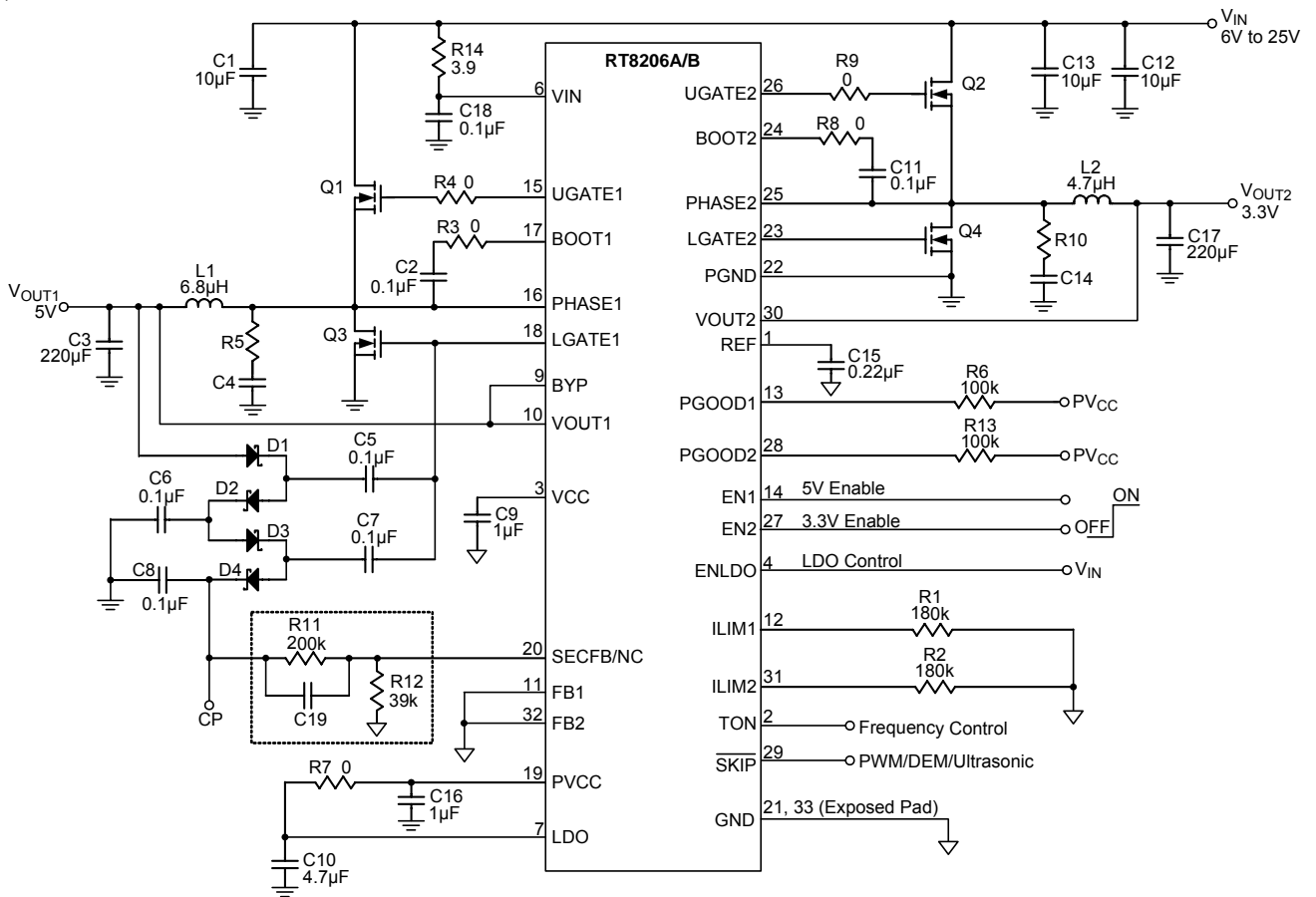

Figure 1. Fixed Voltage Regulator

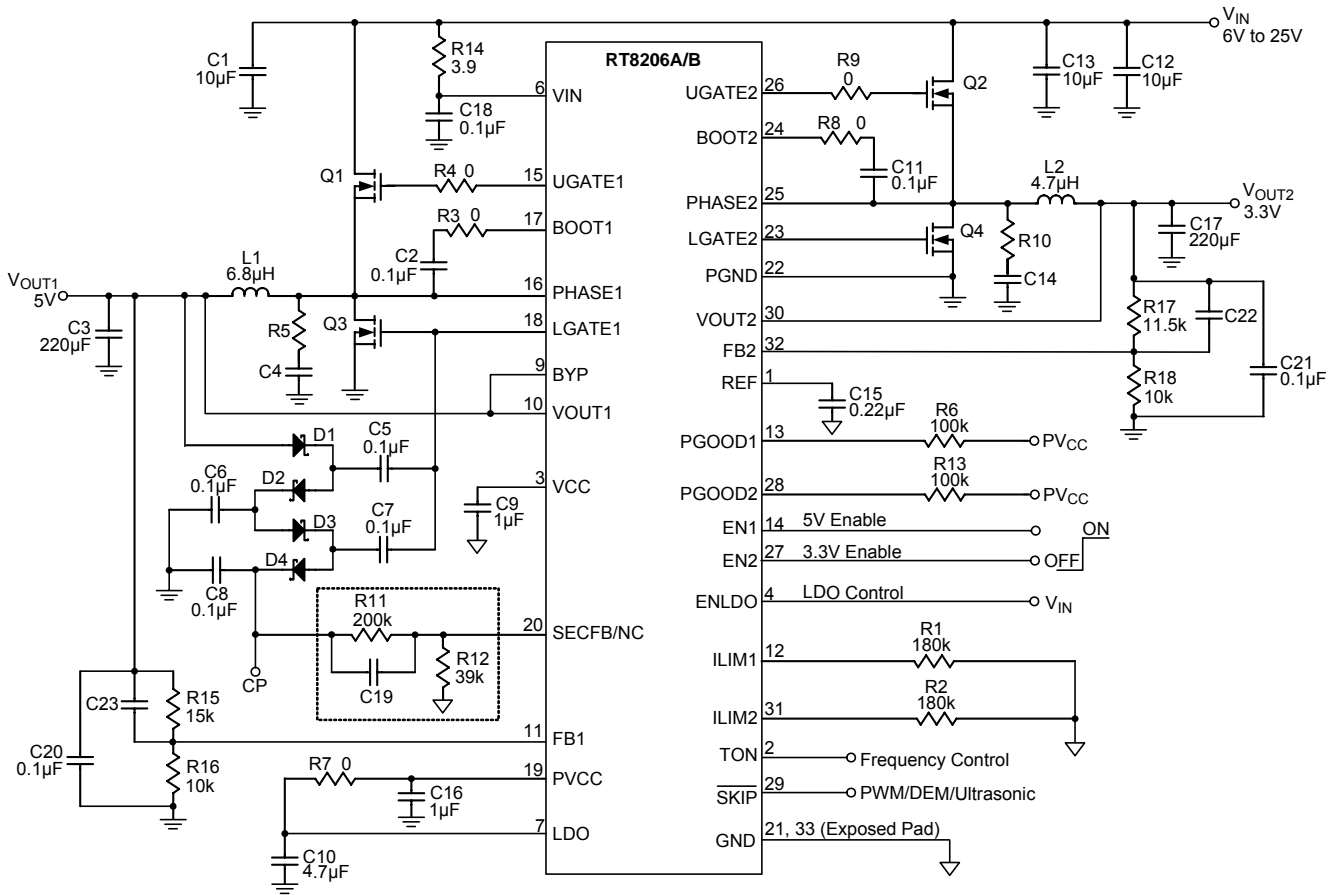
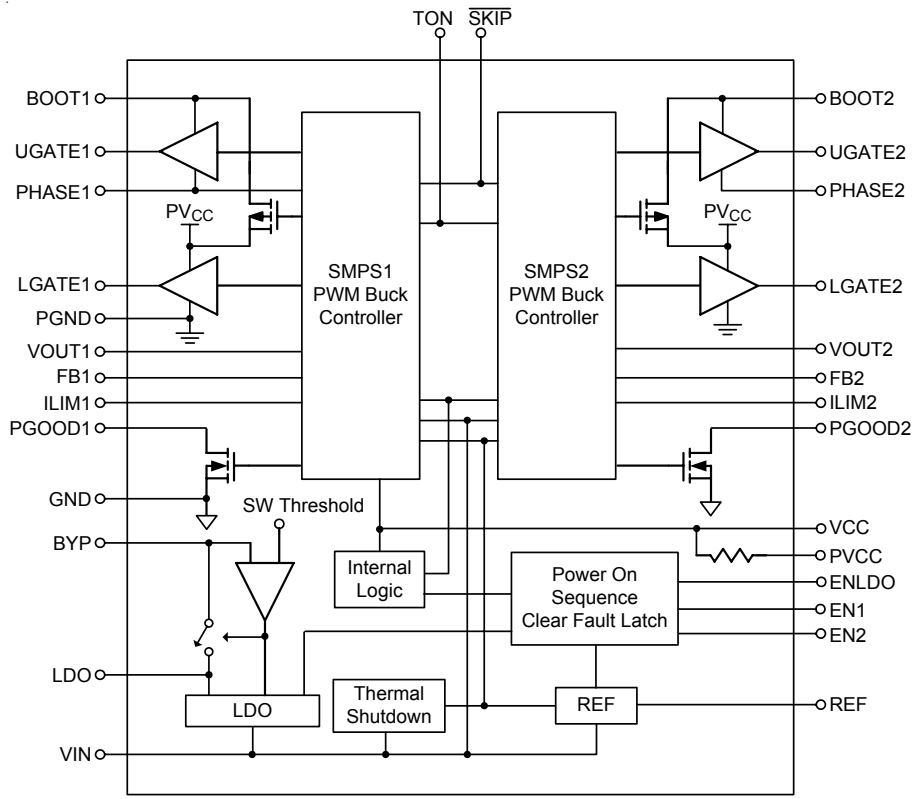
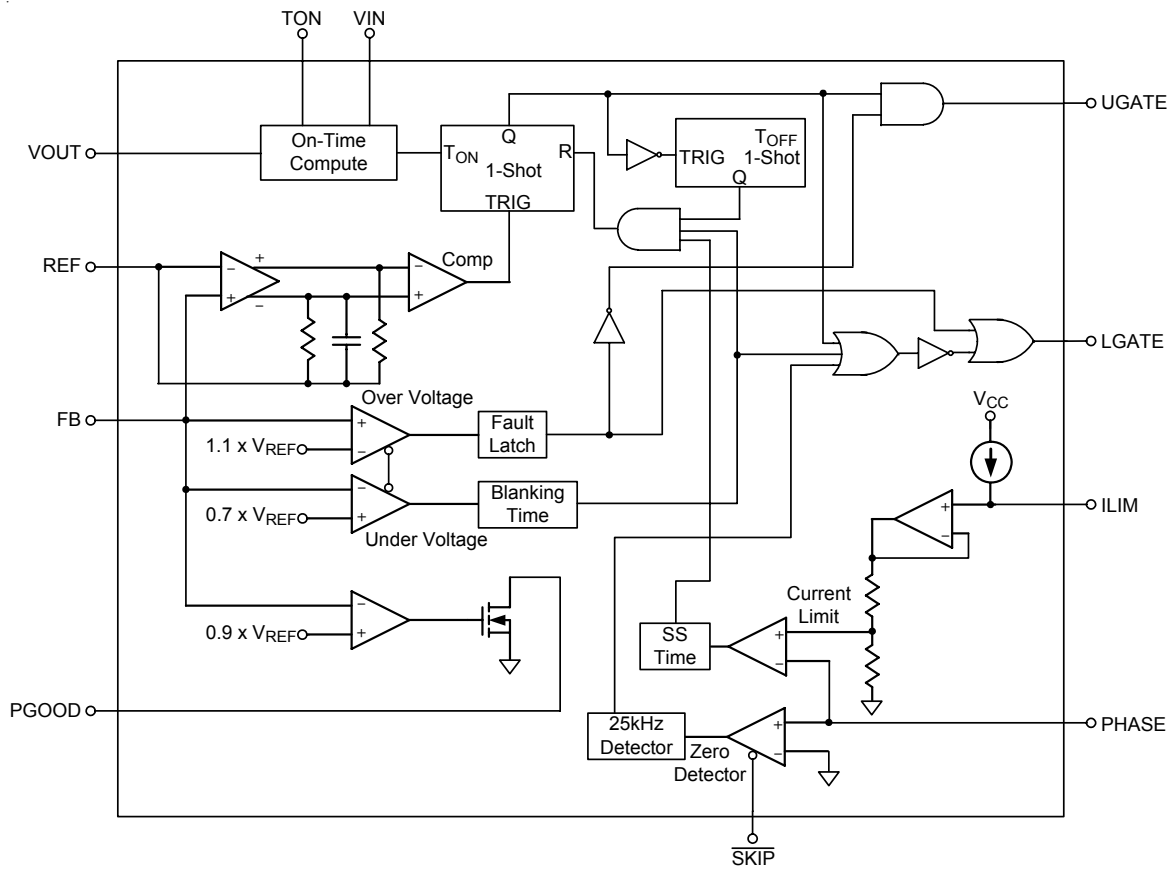

Figure 2. Adjustable Voltage Regulator

Function Block Diagram



Function Block Diagram



PWM Controller (One Side)

## Functional Pin Description

### REF (Pin 1)

2V Reference Output. Bypass to GND with a 0.22 $\mu$ F capacitor. REF can source up to 50 $\mu$ A for external loads. Loading REF degrades FBx and output accuracy according to the REF load regulation error.

### TON (Pin 2)

Frequency Select Input. (VOUT1/VOUT2 switching frequency, respectively) :

TON = VCC, (200kHz / 250kHz)

TON = REF, (300kHz / 375kHz)

TON = GND, (400kHz / 500kHz)

### VCC (Pin 3)

Analog Supply Voltage Input for the PWM Core. Bypass to GND with a 1 $\mu$ F ceramic capacitor

### ENLDO (Pin 4)

LDO Enable Input. The REF/LDO is enabled if ENLDO is within logic high level and disable if ENLDO is less than the logic low level.

### NC (Pin 5, 8)

No Internal Connection.

### VIN (Pin 6)

Power supply Input. VIN is used for the constant on-time PWM one shot circuits. VIN is also used to power the linear regulators. The linear regulators are powered by SMPS1 if VOUT1 is set greater than 4.66V and BYP is tied to VOUT1. Connect VIN to the battery input and bypass with a 1 $\mu$ F capacitor.

### LDO (Pin 7)

Linear Regulator Output. LDO can provide a total of 70mA external loads. The LDO regulates a fixed 5V output. When the BYP is within 5V switchover threshold, the internal regulator shuts down and the LDO output pin connects to BYP through a 1.5 $\Omega$  switch. Bypass LDO output with a minimum of 4.7 $\mu$ F ceramic.

### BYP (Pin 9)

BYP is the switchover source voltage input for the LDO.

### VOUT1 (Pin 10)

SMPS1 Output Voltage Sense Input. Connect this pin to the SMPS1 output. VOUT1 is an input to the Constant on-time-PWM one-shot circuit. It also serves as the SMPS1 feedback input in fixed voltage mode.

### FB1 (Pin 11)

SMPS1 Feedback Input. Connect FB1 to VCC or GND for fixed 5V operation. Connect FB1 to a resistive voltage divider from VOUT1 to GND to adjust output from 2V to 5.5V.

### ILIM1 (Pin 12)

SMPS1 Current Limit Adjustment. The GND – PHASE1 current limit threshold is 1/10th the voltage seen at ILIM1 over a 0.5V to 2V range. There is an internal 5 $\mu$ A current source from VCC to ILIM1. The logic current limit threshold is default to 100mV if ILIM1 is higher than (VCC – 1V).

### PGOOD1 (Pin 13)

SMPS1 Power Good Open-Drain Output. PGOOD1 is low when the SMPS1 output voltage is more than 7.5% below the normal regulation point or during soft-start. PGOOD1 is high impedance when the output is in regulation and the soft-start circuit has terminated. PGOOD1 is low in shutdown.

### EN1 (Pin 14)

SMPS1 Enable Input. The SMPS1 will be enabled if EN1 is greater than the logic high level and disabled if EN1 is less than the logic low level. If EN1 is connected to REF, the SMPS1 starts after the SMPS2 reaches regulation (delay start). Drive EN1 below 0.8V to clear fault level and reset the fault latches.

### UGATE1 (Pin 15)

High Side MOSFET Floating Gate Driver Output for SMPS1. UGATE1 swings between PHASE1 and BOOT1.

### PHASE1 (Pin 16)

Inductor Connection for SMPS1. PHASE1 is the internal lower supply rail for the UGATE1 high side gate driver. PHASE1 is the current sense input for the SMPS1.

**BOOT1 (Pin 17)**

Boost Flying Capacitor Connection for SMPS1. Connect to an external capacitor according to the typical application circuits.

**LGATE1 (Pin 18)**

SMPS1 Synchronous-Rectifier Gate drive Output. LGATE1 swings between PGND and PVCC.

**PVCC (Pin 19)**

PVCC is the supply voltage for the low side MOSFET driver LGATE<sub>x</sub>. Connect a 5V power source to the PVCC pin (bypass with 1 $\mu$ F MLCC capacitor to PGND if necessary). There is an internal 10 $\Omega$  connecting from PVCC to VCC. Make sure that both VCC and PVCC are bypassed with 1 $\mu$ F MLCC capacitors.

**SECFB (Pin 20) (RT8206A)**

The SECFB is used to monitor the optional external 14V charge pump. Connect a resistive voltage divider from the 14V charge pump output to GND to detect the output. If SECFB drops below the threshold voltage, LGATE1 will be turned on for 300ns. This will refresh the external charge pump driven by LGATE1 without over discharging the output voltage.

**NC (Pin 20) (RT8206B)**

No Internal Connection.

**GND [Pin 21, 33 (Exposed Pad)]**

Analog Ground for both SMPS and LDO. The exposed pad must be soldered to a large PCB and connected to GND for maximum power dissipation.

**PGND (Pin 22)**

Power Ground for SMPS controller. Connect PGND externally to the underside of the exposed pad.

**LGATE2 (Pin 23)**

SMPS2 Synchronous-Rectifier Gate drive Output. LGATE2 swings between PGND and PVCC.

**BOOT2 (Pin 24)**

Boost Flying Capacitor Connection for SMPS2. Connect this pin to an external capacitor according to the typical application circuits.

**PHASE2 (Pin 25)**

Inductor Connection for SMPS2. PHASE2 is the internal lower supply rail for the UGATE2 high side gate driver. PHASE2 is the current sense input for the SMPS2.

**UGATE2 (Pin 26)**

High Side MOSFET Floating Gate Driver Output for SMPS2. UGATE2 swings between PHASE2 and BOOT2.

**EN2 (Pin 27)**

SMPS2 Enable Input. The SMPS2 will be enabled if EN2 is greater than the logic high level and be disabled if EN2 is less than the logic low level. If EN2 is connected to REF, the SMPS2 starts after the SMPS1 reaches regulation (delay start). Drive EN2 below 0.8V to clear fault level and reset the fault latches.

**PGOOD2 (Pin 28)**

SMPS2 Power Good Open-Drain Output. PGOOD2 is low when the SMPS2 output voltage is more than 7.5% below the normal regulation point or during soft-start. PGOOD2 is high impedance when the output is in regulation and the soft-start circuit has terminated. PGOOD2 is low in shutdown.

**SKIP (Pin 29)**

SMPS Operation Mode Control.

$\overline{\text{SKIP}}$  = GND : DEM operation

$\overline{\text{SKIP}}$  = REF : Ultrasonic Mode operation

$\overline{\text{SKIP}}$  = VCC : PWM operation.

**VOUT2 (Pin 30)**

SMPS2 Output Voltage Sense Input. Connect this pin to the SMPS2 output. VOUT2 is an input to the constant on-time-PWM one-shot circuit. It also serves as the SMPS2 feedback input in fixed voltage mode.

**ILIM2 (Pin 31)**

SMPS2 Current Limit Adjustment. The GND – PHASE2 current limit threshold is 1/10th the voltage seen at ILIM2 over a 0.5V to 2V range. There is an internal 5 $\mu$ A current source from VCC to ILIM2. The logic current limit threshold is default to 100mV value if ILIM2 is higher than (VCC – 1V).

**FB2 (Pin 32)**

SMPS2 Feedback Input. Connect FB2 to VCC or GND for fixed 3.3V operation. Connect FB2 to a resistive voltage divider from VOUT2 to GND to adjust output from 2V to 5.5V.

## Absolute Maximum Ratings (Note 1)

|  |       |                                    |
|--|-------|------------------------------------|
| • VIN, ENLDO to GND  | ----- | -0.3V to 30V                       |
| • PHASEx to GND  |       |                                    |
| DC   | ----- | -0.3V to 30V                       |
| <20ns  | ----- | -8V to 38V                         |
| • BOOTx to PHASEx  | ----- | -0.3V to 6V                        |
| • VCC, ENx, $\overline{\text{SKIP}}$ , TON, PVCC, PGOODx, to GND | ----- | -0.3V to 6V                        |
| • LDO, FBx, VOUTx, SECFB, REF, ILIMx to GND                      | ----- | -0.3V to (V <sub>CC</sub> + 0.3V)  |
| • UGATEx to PHASEx   |       |                                    |
| DC   | ----- | -0.3V to (PV <sub>CC</sub> + 0.3V) |
| <20ns  | ----- | -5V to 7.5V                        |
| • LGATEx, BYP to GND   |       |                                    |
| DC   | ----- | -0.3V to (PV <sub>CC</sub> + 0.3V) |
| <20ns  | ----- | -2.5V to 7.5V                      |
| • PGND to GND  | ----- | -0.3V to 0.3V                      |
| • Power Dissipation, P <sub>D</sub> @ T <sub>A</sub> = 25°C      |       |                                    |
| WQFN-32L 5x5   | ----- | 2.778W                             |
| • Package Thermal Resistance (Note 2)                            |       |                                    |
| WQFN-32L 5x5, $\theta_{JA}$                                      | ----- | 36°C/W                             |
| WQFN-32L 5x5, $\theta_{JC}$                                      | ----- | 7°C/W                              |
| • Junction Temperature   | ----- | 150°C                              |
| • Lead Temperature (Soldering, 10 sec.)                          | ----- | 260°C                              |
| • Storage Temperature Range                                      | ----- | -65°C to 150°C                     |
| • ESD Susceptibility (Note 3)                                    |       |                                    |
| HBM (Human Body Mode)  | ----- | 2kV                                |
| MM (Machine Mode)  | ----- | 200V                               |

## Recommended Operating Conditions (Note 4)

|                                  |       |                |
|----------------------------------|-------|----------------|
| • Input Voltage, V <sub>IN</sub> | ----- | 6V to 25V      |
| • Junction Temperature Range     | ----- | -40°C to 125°C |
| • Ambient Temperature Range      | ----- | -40°C to 85°C  |



**Electrical Characteristics**

( $V_{IN} = 12V$ ,  $EN1 = EN2 = V_{CC}$ ,  $V_{BYP} = 5V$ ,  $PV_{CC} = 5V$ ,  $V_{ENLDO} = 5V$ , No Load on LDO,  $V_{OUT1}$ ,  $V_{OUT2}$  and REF,  $T_A = 25^\circ C$ , unless otherwise specified)

| Parameter                             | Symbol          | Test Conditions   | Min                    | Typ   | Max   | Unit    |    |
|---------------------------------------|-----------------|---|------------------------|-------|-------|---------|----|
| <b>Input Supply</b>                   |                 |   |                        |       |       |         |    |
| VIN Standby Supply Current            | $I_{VIN\_SBY}$  | $V_{IN} = 6V$ to $25V$ , Both SMPS Off, ENLDO = 5V  | --                     | 180   | 250   | $\mu A$ |    |
| VIN Shutdown Supply Current           | $I_{VIN\_SHDH}$ | $V_{IN} = 6V$ to $25V$ , ENx = ENLDO = GND  | --                     | 20    | 40    | $\mu A$ |    |
| Quiescent Power Consumption           |                 | Both SMPSs On, FB1 = $\overline{SKIP}$ = GND, FB2 = $V_{CC}$ , $V_{OUT1} = BYP = 5.3V$ , $V_{OUT2} = 3.5V$ (Note 5) | --                     | 5     | 7     | mW      |    |
| <b>SMPS Output and FB Voltage</b>     |                 |   |                        |       |       |         |    |
| VOUT1 Output Voltage in Fixed Mode    | $V_{OUT1}$      | $V_{IN} = 6V$ to $25V$ , FB1= GND, $\overline{SKIP} = 5V$   | 4.975                  | 5.05  | 5.125 | V       |    |
| VOUT2 Output Voltage in Fixed Mode    | $V_{OUT2}$      | $V_{IN} = 6V$ to $25V$ , FB2 = $V_{CC}$ , $\overline{SKIP} = 5V$  | 3.285                  | 3.33  | 3.375 | V       |    |
| FBx in Output Adjustable Mode         | FBx             | $V_{IN} = 6V$ to $25V$  | 1.975                  | 2     | 2.025 | V       |    |
| SECFB Voltage                         | SECFB           | $V_{IN} = 6V$ to $25V$ (RT8206A)  | 1.92                   | 2     | 2.08  | V       |    |
| Output Voltage Adjust Range           |                 | SMPS1, SMPS2  | 2                      | --    | 5.5   | V       |    |
| FBx Adjustable-mode Threshold Voltage |                 | Fixed or Adj-Mode comparator threshold  | 0.2                    | 0.4   | 0.55  | V       |    |
| DC Load Regulation                    | $V_{LOAD}$      | Either SMPS, $\overline{SKIP} = V_{CC}$ , 0 to 5A   | --                     | -0.1  | --    | %       |    |
|                                       |                 | Either SMPS, $\overline{SKIP} = REF$ , 0 to 5A  | --                     | -1.7  | --    |         |    |
|                                       |                 | Either SMPS, $\overline{SKIP} = GND$ , 0 to 5A  | --                     | -1.5  | --    |         |    |
| Line Regulation                       | $V_{LINE}$      | Either SMPS, $V_{IN} = 6V$ to $25V$   | --                     | 0.005 | --    | %/V     |    |
| <b>On Time</b>                        |                 |   |                        |       |       |         |    |
| On-Time Pulse Width                   | $t_{UGATEX}$    | TON = $V_{CC}$  | SMPS1 = 5.05V (200kHz) | 1895  | 2105  | 2315    | ns |
|                                       |                 |   | SMPS2 = 3.33V (250kHz) | 999   | 1110  | 1221    |    |
|                                       |                 | TON = REF   | SMPS1 = 5.05V (300kHz) | 1227  | 1403  | 1579    |    |
|                                       |                 |   | SMPS2 = 3.33V (375kHz) | 647   | 740   | 833     |    |
|                                       |                 | TON = GND   | SMPS1 = 5.05V (400kHz) | 895   | 1052  | 1209    |    |
|                                       |                 | SMPS2 = 3.33V (500kHz)  | 475                    | 555   | 635   |         |    |
| Minimum Off-Time                      | $t_{LGATEX}$    |   | 200                    | 300   | 400   | ns      |    |
| Ultrasonic Mode Frequency             |                 | $\overline{SKIP} = REF$   | 25                     | 33    | --    | kHz     |    |
| <b>Soft Start</b>                     |                 |   |                        |       |       |         |    |
| Soft-Start Time                       | $t_{SSx}$       | Zero to full limit from ENx Enable  | --                     | 2     | --    | ms      |    |
| <b>Current Sense</b>                  |                 |   |                        |       |       |         |    |
| Current Limit Threshold (Default)     |                 | $I_{LIMx} = V_{CC}$ , GND – PHASEx  | 90                     | 100   | 110   | mV      |    |
| Current Limit Current Source          | $I_{LIMX}$      |   | 4.75                   | 5     | 5.25  | $\mu A$ |    |

*To be continued*

| Parameter                               | Symbol                | Test Conditions   | Min                 | Typ  | Max  | Unit |    |
|---|-----------------------|---|---------------------|------|------|------|----|
| I <sub>LIM</sub> Adjustment Range       |                       | $V_{ILIMx} = I_{LIMx} \times R_{ILIMx}$   | 0.5                 | --   | 2    | V    |    |
| Current-Limit Threshold                 |                       | GND<br>– PHASE <sub>x</sub>   | $V_{ILIMx} = 0.5V$  | 40   | 50   | 60   | mV |
|   |                       |   | $V_{ILIMx} = 1V$    | 90   | 100  | 110  |    |
|   |                       |   | $V_{ILIMx} = 2V$    | 180  | 200  | 220  |    |
| Zero-Current Threshold                  |                       | $\overline{SKIP} = GND$ or REF, GND – PHASE <sub>x</sub>                          | --                  | 3    | --   | mV   |    |
| <b>Internal Regulator and Reference</b> |                       |   |                     |      |      |      |    |
| LDO Output Voltage                      | V <sub>LDO</sub>      | BYP = GND, 6V < V <sub>IN</sub> < 25V,<br>0 < I <sub>LDO</sub> < 70mA             | 4.9                 | 5    | 5.1  | V    |    |
| LDO Output Current                      | I <sub>LDO</sub>      | BYP = GND, V <sub>IN</sub> = 6V to 25V  | 70                  | --   | --   | mA   |    |
| LDO Short-Circuit Current               |                       | LDO = GND, BYP = GND  | --                  | 200  | 300  | mA   |    |
| LDO 5V Switchover Threshold to BYP      | V <sub>BYP</sub>      | Falling Edge, Rising Edge at BYP Regulation Point                                 | 4.53                | 4.66 | 4.79 | V    |    |
| LDO Switchover Equivalent Resistance    | R <sub>SW</sub>       | LDO to BYP, 10mA  | --                  | 1.5  | 3    | Ω    |    |
| REF Output Voltage                      | V <sub>REF</sub>      | No External Load  | 1.98                | 2    | 2.02 | V    |    |
| REF Load Regulation                     |                       | I <sub>REF</sub> = 0 to 50μA  | --                  | 10   | --   | mV   |    |
| REF Sink Current                        |                       | REF in Regulation   | 10                  | --   | --   | μA   |    |
| <b>UVLO</b>                             |                       |   |                     |      |      |      |    |
| PVCC UVLO Threshold                     | PVCC                  | Rising Edge   | --                  | 4.35 | 4.5  | V    |    |
|   |                       | Falling Edge  | 3.9                 | 4.05 | --   |      |    |
| <b>Power Good</b>                       |                       |   |                     |      |      |      |    |
| PGOOD <sub>x</sub> Threshold            |                       | FB <sub>x</sub> with Respect to Internal Reference, Falling Edge, Hysteresis = 1% | -11                 | -7.5 | -4   | %    |    |
| PGOOD <sub>x</sub> Propagation Delay    |                       | Falling Edge  | --                  | 10   | --   | μs   |    |
| PGOOD <sub>x</sub> Leakage Current      |                       | High State, Forced to 5.5V  | --                  | --   | 1    | μA   |    |
| PGOOD <sub>x</sub> Output Low Voltage   |                       | I <sub>SINK</sub> = 4mA   | --                  | --   | 0.3  | V    |    |
| <b>Fault Detection</b>                  |                       |   |                     |      |      |      |    |
| OVP Trip Threshold                      | V <sub>FB_OVP</sub>   | FB <sub>x</sub> with Respect to Internal Ref.                                     | 108                 | 111  | 115  | %    |    |
| OVP Propagation Delay                   |                       | FB <sub>x</sub> with 50mV Overdrive   | --                  | 10   | --   | μs   |    |
| UVP Trip Threshold                      |                       | FB <sub>x</sub> with Respect to Internal Ref.                                     | 65                  | 70   | 75   | %    |    |
| UVP Shutdown Blanking Time              | t <sub>SHDN_UVP</sub> | From EN <sub>x</sub> Enable   | --                  | 3    | --   | ms   |    |
| <b>Thermal Shutdown</b>                 |                       |   |                     |      |      |      |    |
| Thermal Shutdown                        | T <sub>SHDN</sub>     |   | --                  | 150  | --   | °C   |    |
| Thermal Shutdown Hysteresis             |                       |   | --                  | 10   | --   | °C   |    |
| <b>Logic Input</b>                      |                       |   |                     |      |      |      |    |
| FB1/FB2 Input Voltage                   |                       | Low Level (Internal Fixed V <sub>OUTx</sub> )                                     | --                  | --   | 0.2  | V    |    |
|   |                       | High Level (Internal Fixed V <sub>OUTx</sub> )                                    | V <sub>CC</sub> – 1 | --   | --   |      |    |

To be continued

| Parameter                                    | Symbol             | Test Conditions   | Min  | Typ | Max  | Unit |
|--|--------------------|---|------|-----|------|------|
| SKIP Input Voltage                           |                    | Low Level (DEM)   | --   | --  | 0.8  | V    |
|  |                    | REF Level (Ultrasonic Mode)                             | 1.8  | --  | 2.3  |      |
|  |                    | High Level (PWM Mode)                                   | 2.5  | --  | --   |      |
| TON Setting Voltage                          |                    | V <sub>OUT1</sub> / V <sub>OUT2</sub> (400kHz / 500kHz) | --   | --  | 0.8  | V    |
|  |                    | V <sub>OUT1</sub> / V <sub>OUT2</sub> (300kHz / 375kHz) | 1.8  | --  | 2.3  |      |
|  |                    | V <sub>OUT1</sub> / V <sub>OUT2</sub> (200kHz / 250kHz) | 2.5  | --  | --   |      |
| ENx Input Voltage                            |                    | Clear Fault Level / SMPS Off Level                      | --   | --  | 0.8  | V    |
|  |                    | Delay Start   | 1.8  | --  | 2.3  |      |
|  |                    | SMPS On Level   | 2.5  | --  | --   |      |
| ENLDO Input Voltage                          | V <sub>ENLDO</sub> | Rising Edge   | 1.2  | 1.6 | 2.0  | V    |
|  |                    | Falling Edge  | 0.94 | 1   | 1.06 |      |
| Input Leakage Current                        |                    | ENLDO = 0V or 25V                                       | -1   | --  | +3   | μA   |
|  |                    | ENx = 0V or 5V  | -1   | --  | +1   |      |
|  |                    | TON, SKIP = 0V or 5V                                    | -1   | --  | +1   |      |
|  |                    | FBx = 0V or 5V  | -1   | --  | +1   |      |
|  |                    | SECFB = 0V or 5V (RT8206A)                              | -1   | --  | +1   |      |
| <b>Internal BOOT Switch</b>                  |                    |   |      |     |      |      |
| Internal Boost Charging Switch On-Resistance |                    | PVCC to BOOTx   | --   | 20  | --   | Ω    |
| <b>Power MOSFET Drivers</b>                  |                    |   |      |     |      |      |
| UGATEx Driver Sink/Source Current            |                    | UGATEx Forced to 2V                                     | --   | 2   | --   | A    |
| LGATEx Driver Source Current                 |                    | LGATEx Forced to 2V                                     | --   | 1.7 | --   | A    |
| LGATEx Driver Sink Current                   |                    | LGATEx Forced to 2V                                     | --   | 3.3 | --   | A    |
| UGATEx On-Resistance                         |                    | BOOTx to PHASEx Forced to 5V                            | --   | 1.5 | 4    | Ω    |
| LGATEx On-Resistance                         |                    | LGATEx, High State                                      | --   | 2.2 | 5    | Ω    |
|  |                    | LGATEx, Low State                                       | --   | 0.6 | 1.5  |      |
| Dead Time                                    |                    | LG Rising   | --   | 30  | --   | ns   |
|  |                    | UG Rising   | --   | 40  | --   |      |

**Note 1.** Stresses beyond those listed under “Absolute Maximum Ratings” may cause permanent damage to the device. These are stress ratings only, and functional operation of the device at these or any other conditions beyond those indicated in the operational sections of the specifications is not implied. Exposure to absolute maximum rating conditions for extended periods may affect device reliability.

**Note 2.** θ<sub>JA</sub> is measured in the natural convection at T<sub>A</sub> = 25°C on a high effective four layers thermal conductivity test board of JEDEC 51-7 thermal measurement standard.

**Note 3.** Devices are ESD sensitive. Handling precaution is recommended.

**Note 4.** The device is not guaranteed to function outside its operating conditions.

**Note 5.** P<sub>VIN</sub> + P<sub>PVCC</sub>

Typical Operating Characteristics

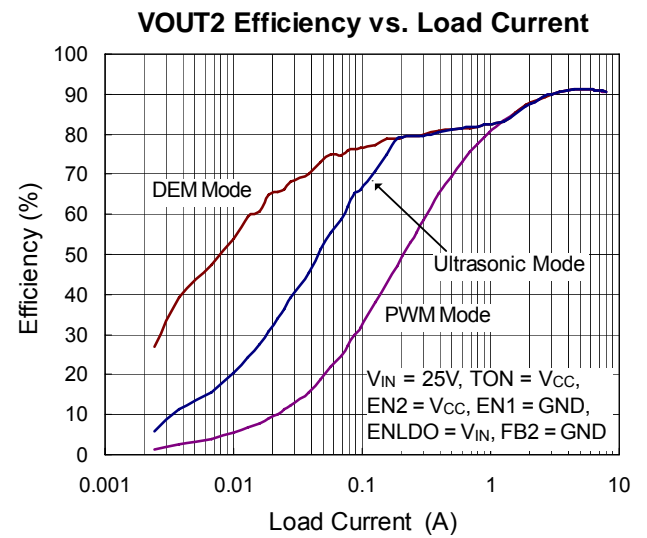
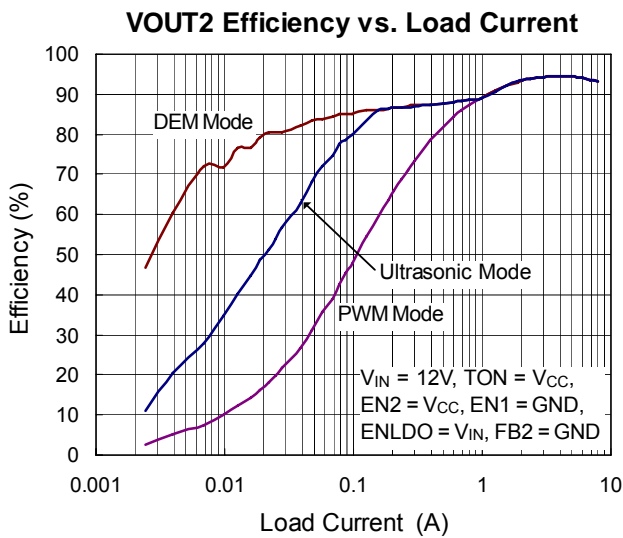
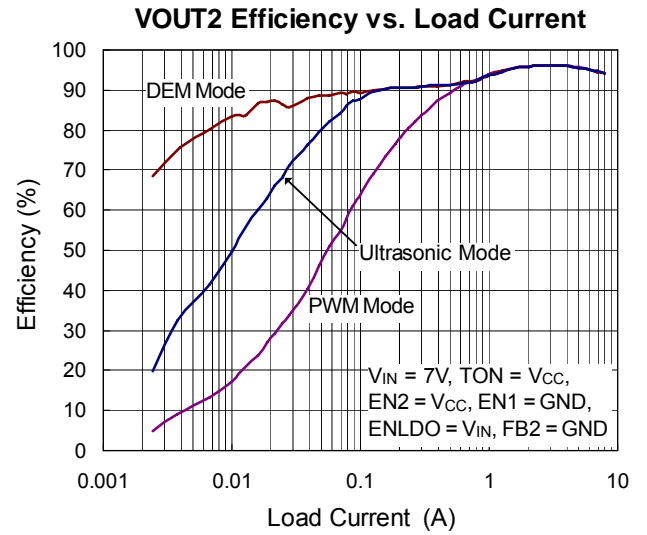
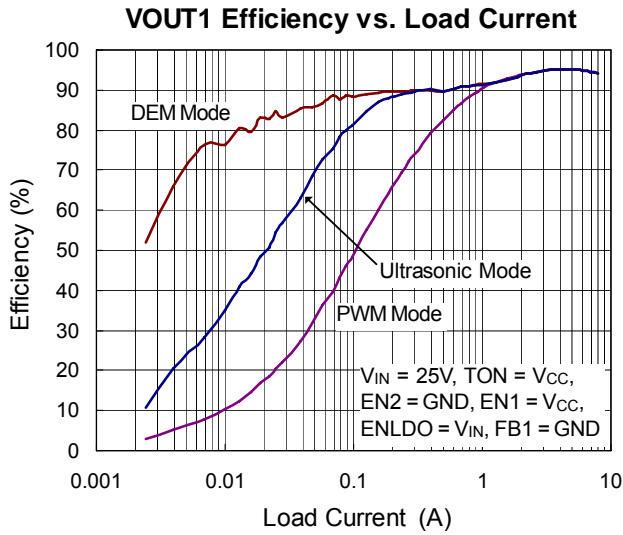
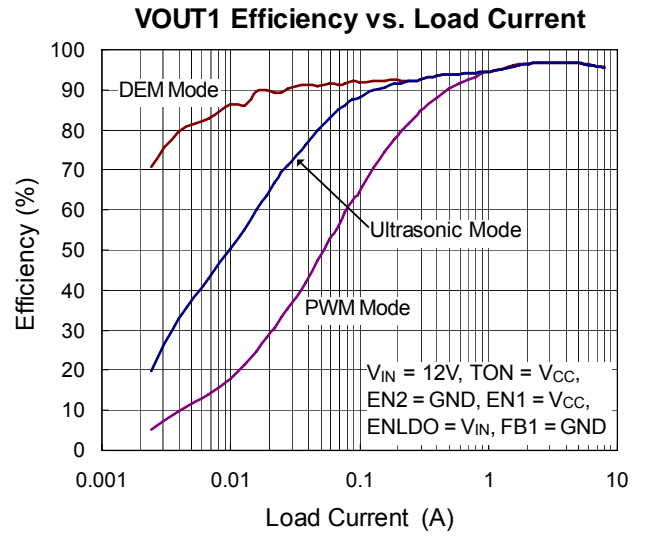
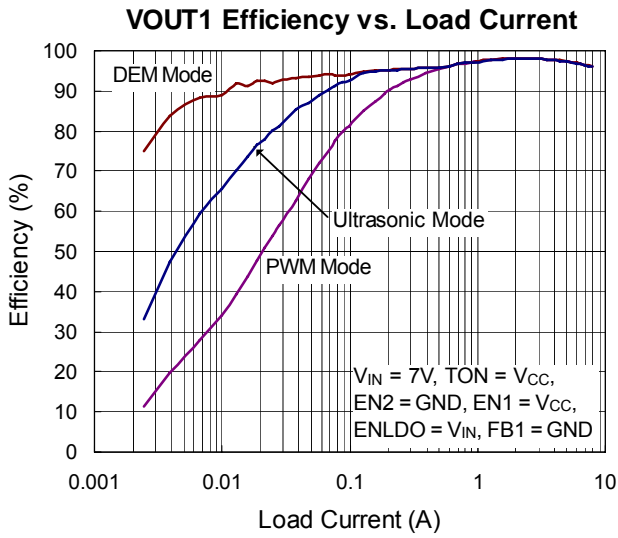

VOUT1 Switching Frequency vs. Load Current

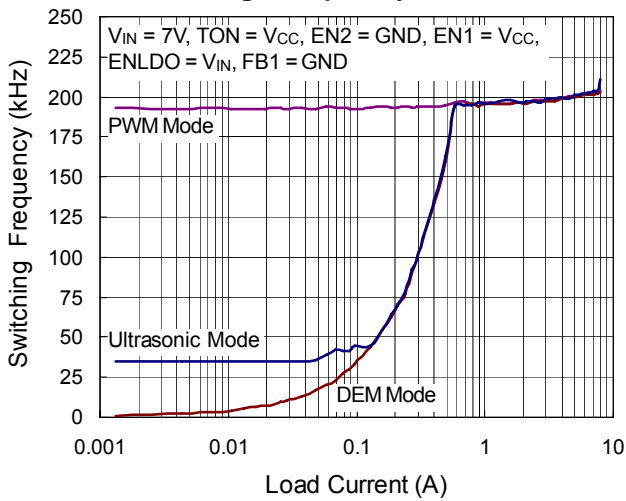

VOUT1 Switching Frequency vs. Load Current

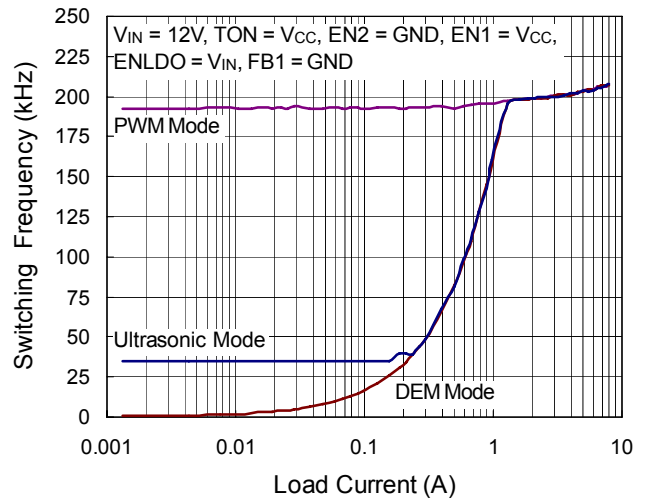

VOUT1 Switching Frequency vs. Load Current

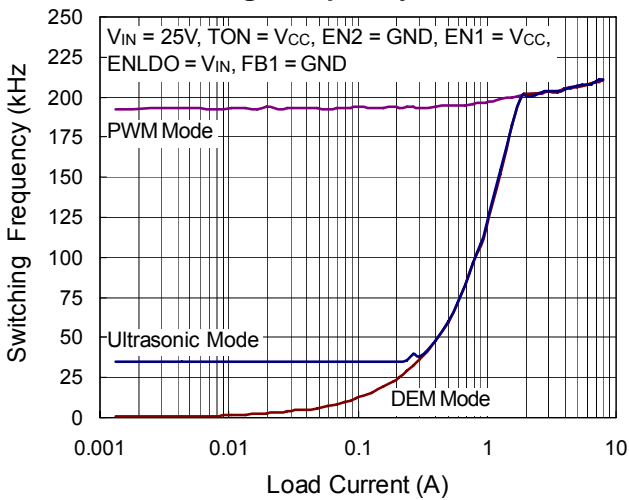

VOUT2 Switching Frequency vs. Load Current

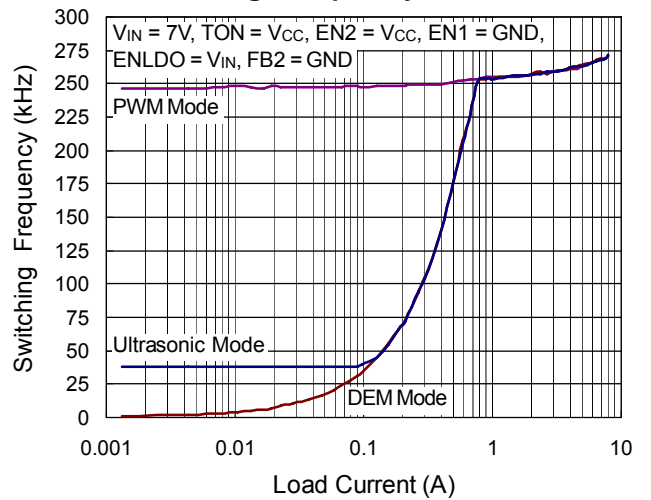

VOUT2 Switching Frequency vs. Load Current

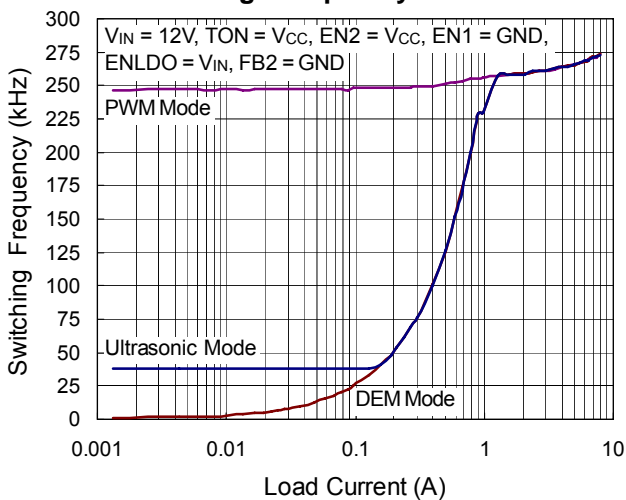

VOUT2 Switching Frequency vs. Load Current

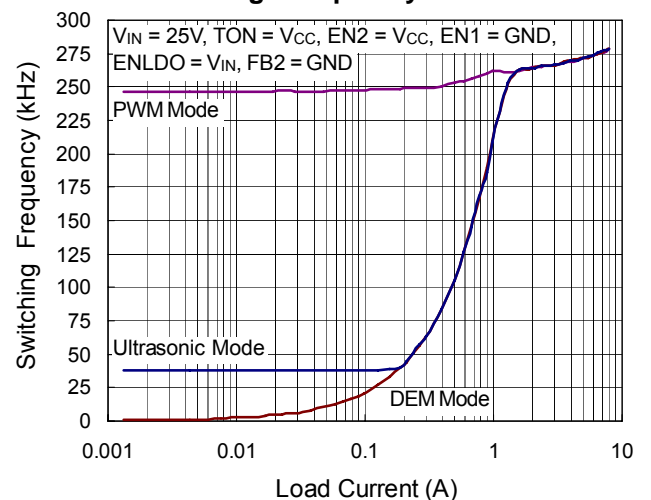

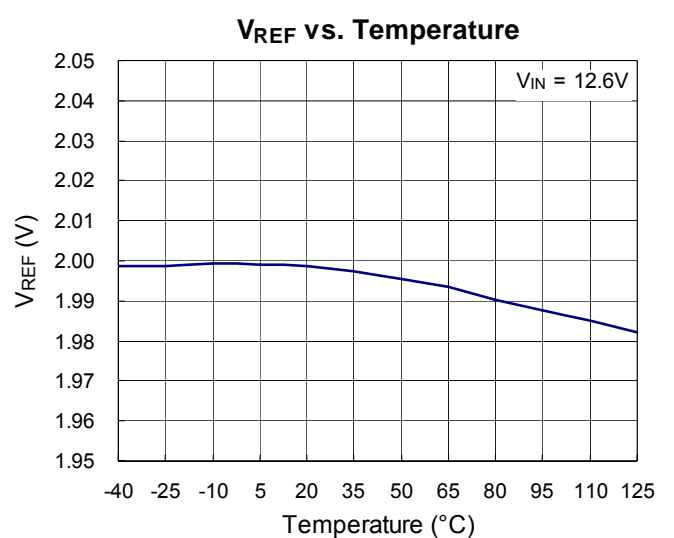
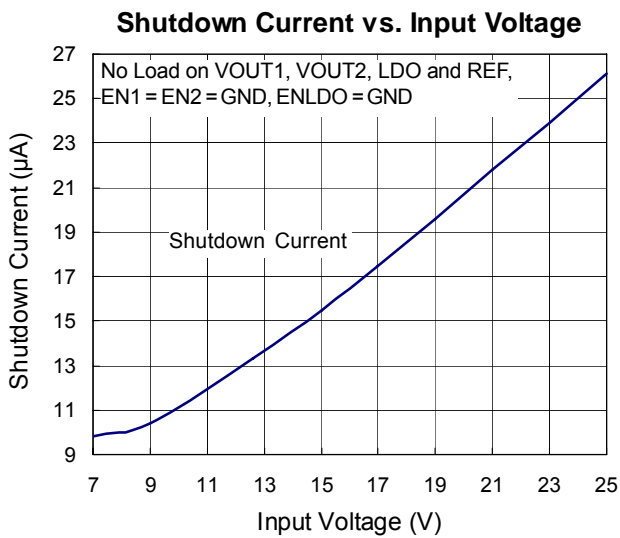
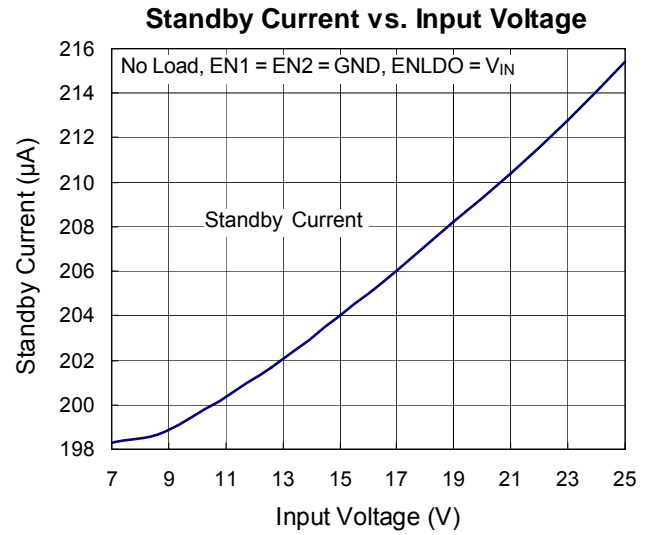
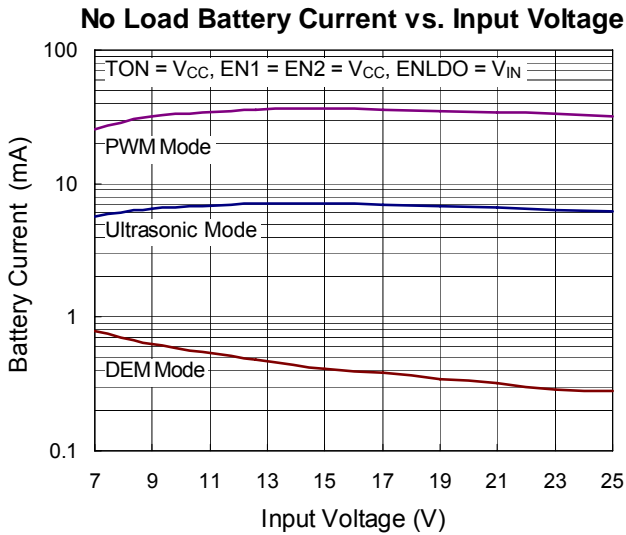
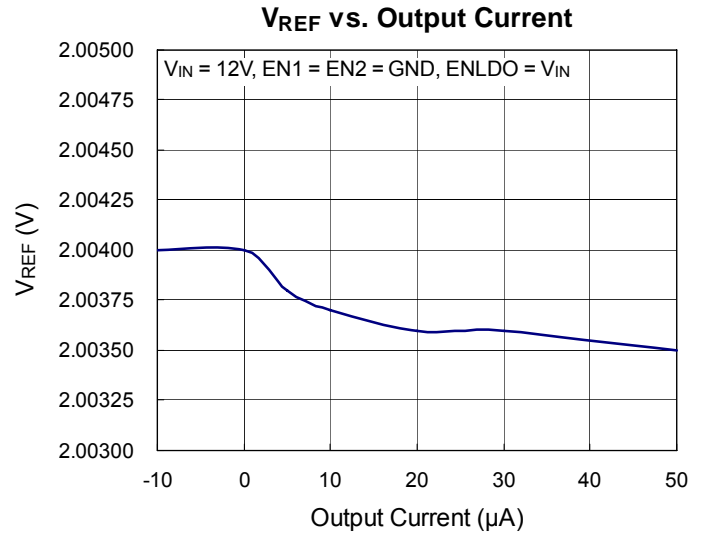
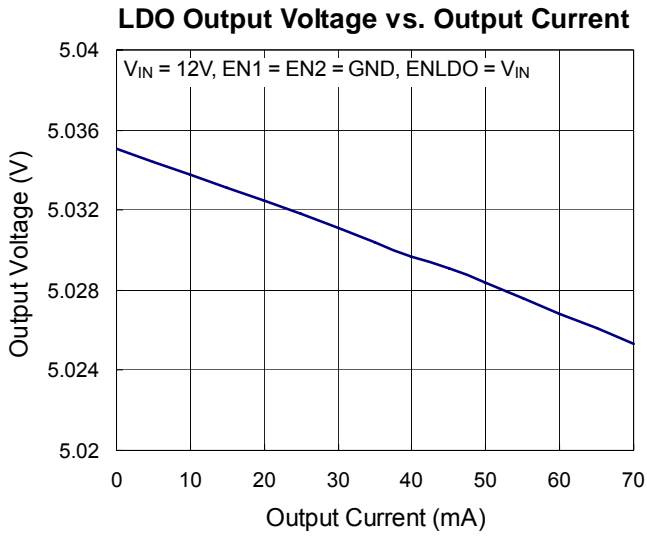

Power On from VIN

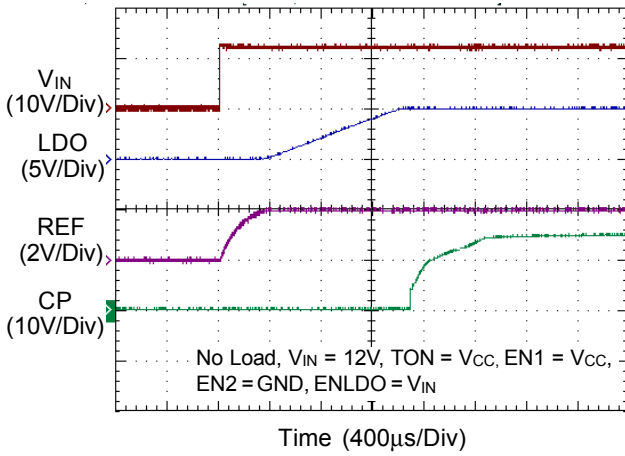

Power On from EN1

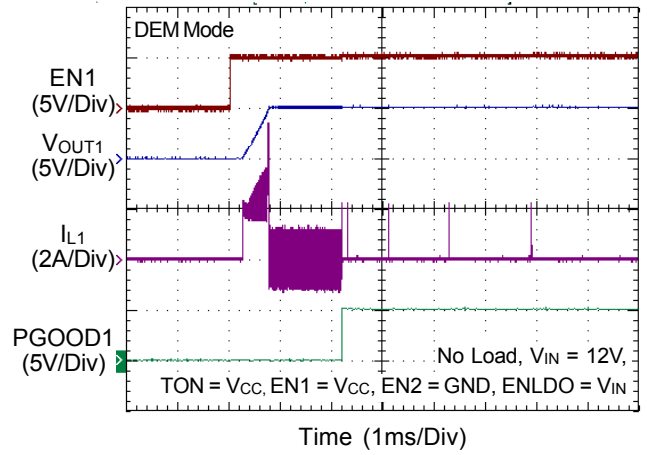

Power On from EN1

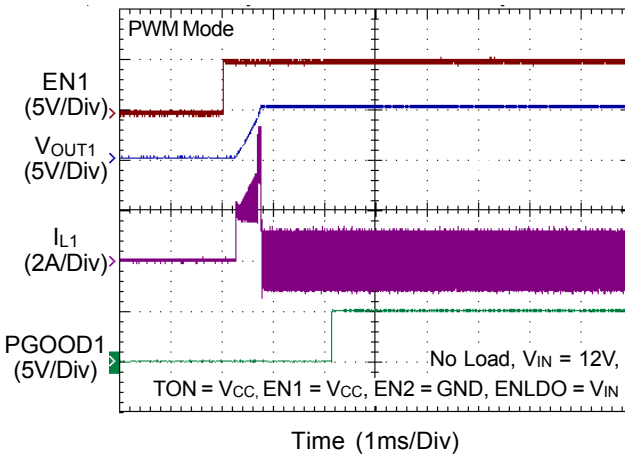

Power On from EN1

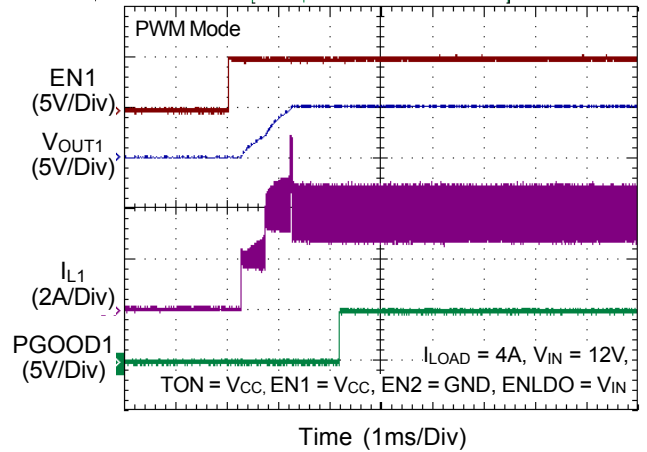

Power On from EN2

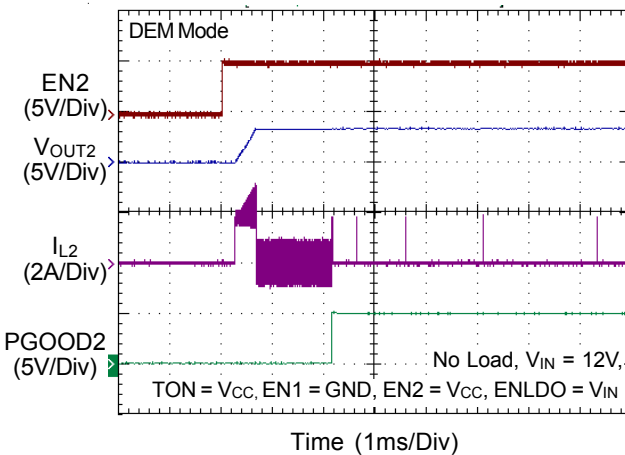

Power On from EN2

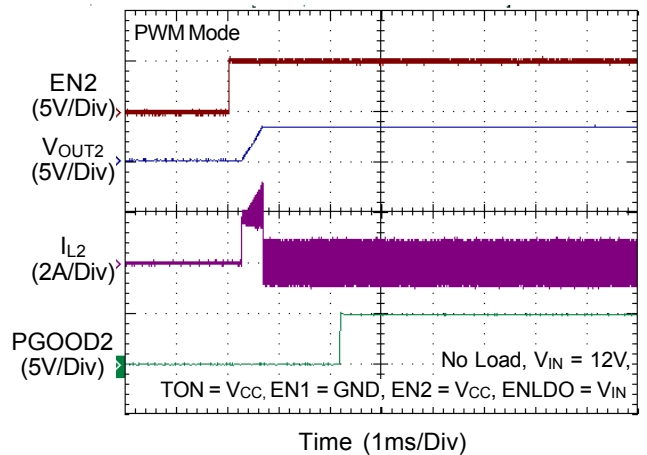

Power On from EN2

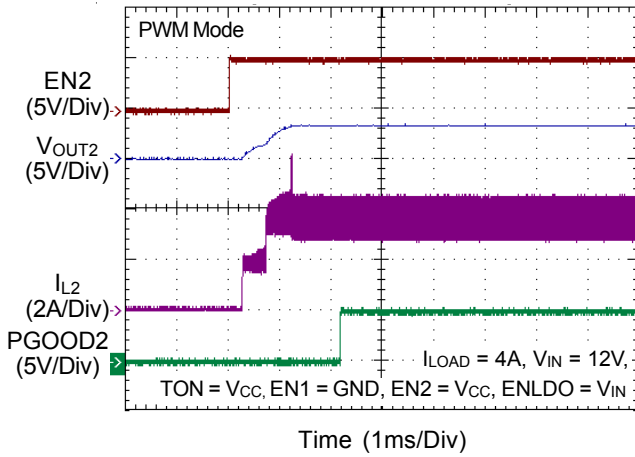

Power On from EN1 (Delay Start)

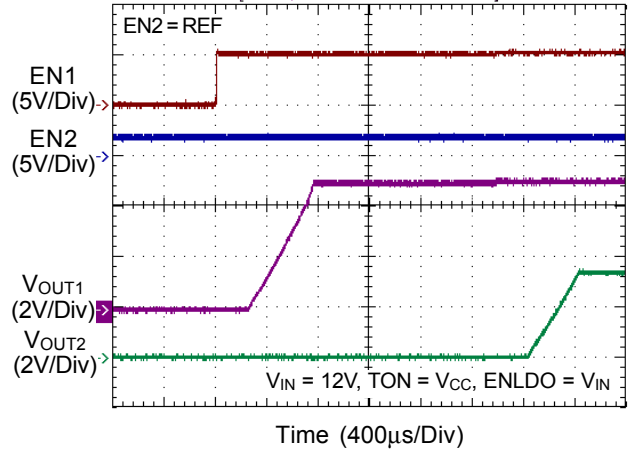

Power On from EN2 (Delay Start)

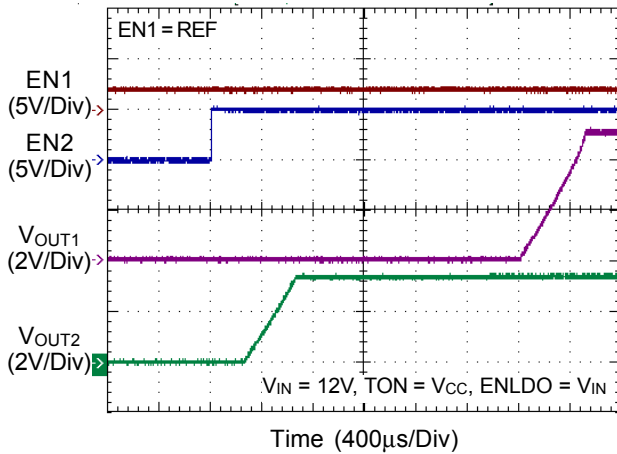

Power Off from EN1

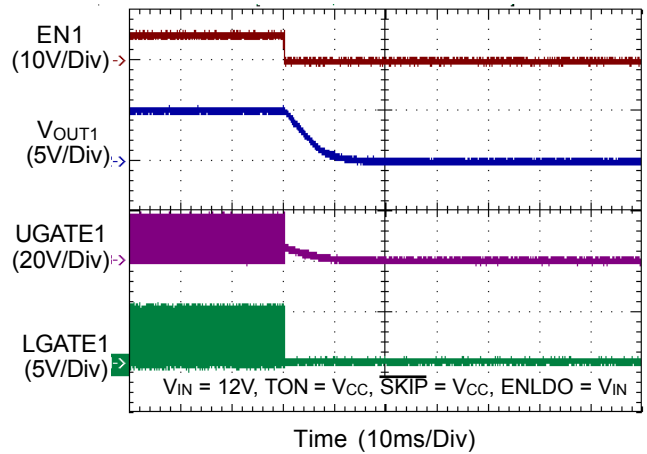

VOUT1 Load Transient Response

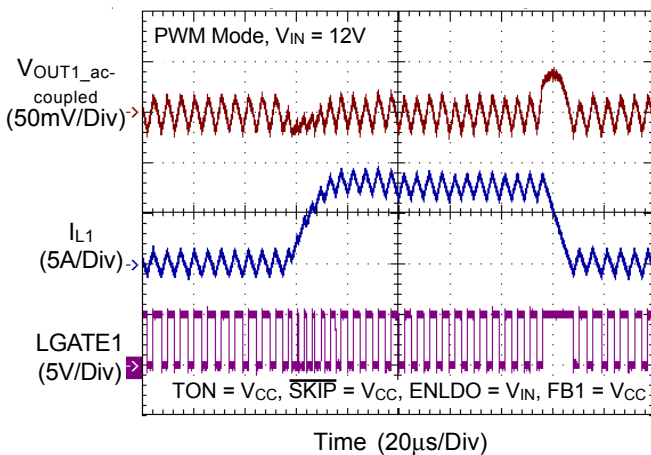

VOUT2 Load Transient Response

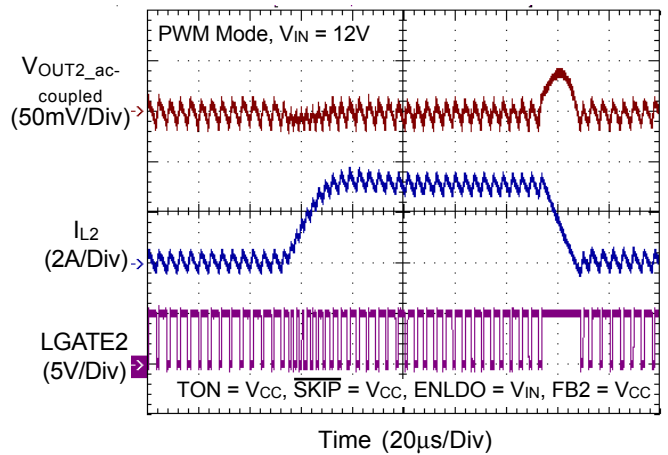



OVP

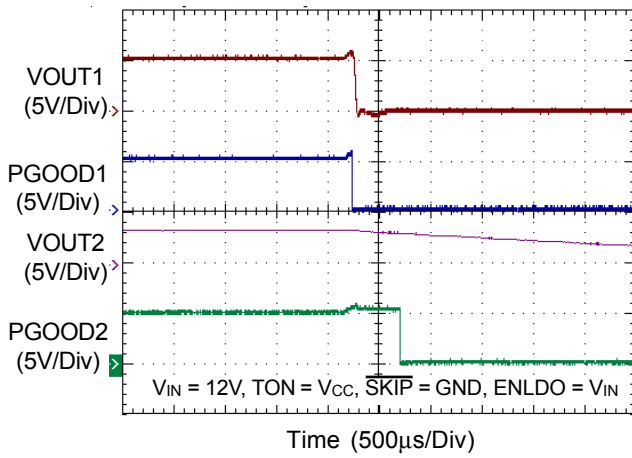

UVP

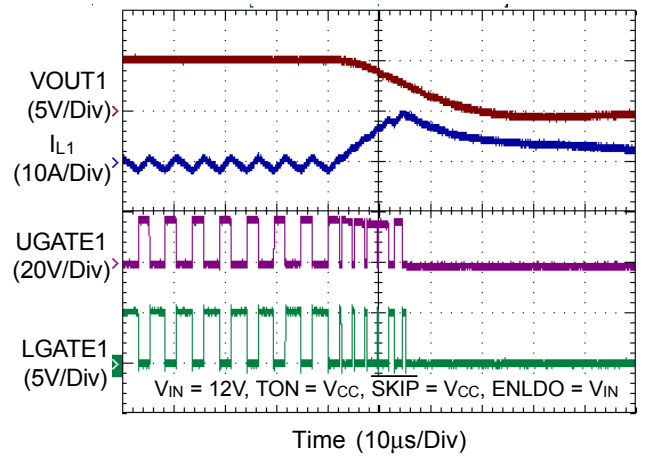

Power On in Short Circuit

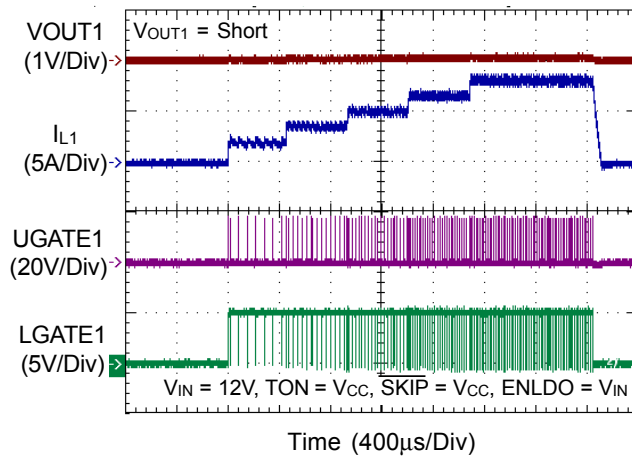

## Application Information

The RT8206A/B is a dual, high efficiency, Mach Response™ DRV™ dual ramp valley mode synchronous buck controller. The controller is designed for low voltage power supplies for notebook computers. Richtek Mach Response™ technology is specifically designed for providing 100ns “instant-on” response to load steps while maintaining a relatively constant operating frequency and inductor operating point over a wide range of input voltages. The DRV™ mode PWM modulator is specifically designed to have better noise immunity for such a dual output application. The RT8206A/B achieves high efficiency at a reduced cost by eliminating the current sense resistor found in traditional current mode PWMs. Efficiency is further enhanced by its ability to drive very large synchronous rectifier MOSFETs. The RT8206A/B includes 5V (LDO) linear regulator which can step down the battery voltage to supply both internal circuitry and gate drivers. When V<sub>OUT1</sub> voltage is above 4.66V, an automatic circuit turns off the linear regulator and powers the device from V<sub>OUT1</sub> through BYP pin connected to V<sub>OUT1</sub>.

### PWM Operation

The Mach Response™ DRV™ mode controller relies on the output filter capacitor's Effective Series Resistance (ESR) to act as a current sense resistor, so the output ripple voltage provides the PWM ramp signal. Refer to the function block diagram, the UGATE driver will be turned on at the beginning of each cycle. After the internal one-shot timer expires, the UGATE driver will be turned off. The pulse width of this one shot is determined by the converter's input voltage and the output voltage to keep the frequency fairly constant over the input voltage range. Another one-shot sets a minimum off-time (300ns typ.). The on-time one-shot is triggered if the error comparator is high, the low side switch current is below the current limit threshold, and the minimum off-time one-shot has timed out.

### PWM Frequency and On-Time Control

The Mach Response™ control architecture runs with pseudo constant frequency by feed forwarding the input and output voltage into the on-time one-shot timer. The high side switch on-time is inversely proportional to the

input voltage as measured by the V<sub>IN</sub>, and proportional to the output voltage. The on-time is given by :

$$\text{On-Time} = K (V_{\text{OUT}} / V_{\text{IN}})$$

There “K” is set by the TON pin-strap connector (Table 1). One-shot timing error increases for the shorter on-time setting due to fixed propagation delays that is approximately ±15% at high frequency and the ±10% at low frequency. The on-time guaranteed in the Electrical Characteristics tables is influenced by switching delays in the external high side power MOSFET. Two external factors that influence switching frequency accuracy are resistive drops in the two conduction loops (including inductor and PC board resistance) and the dead-time effect. These effects are the largest contributors to the change of frequency with changing load current. The dead-time effect increases the effective on-time, reducing the switching frequency as one or both dead times. It occurs only in PWM mode ( $\overline{\text{SKIP}} = \text{high}$ ) when the inductor current reverses at light or negative load currents. With reversed inductor current, the inductor's EMF causes PHASE<sub>x</sub> to go high earlier than normal, extending the on-time by a period equal to the low-to-high dead time. For loads above the critical conduction point, the actual switching frequency is :

$$f_s = (V_{\text{OUT}} + V_{\text{DROPP1}}) / T_{\text{ON}} \times (V_{\text{IN}} + V_{\text{DROPP1}} - V_{\text{DROPP2}})$$

The V<sub>DROPP1</sub> is the sum of the parasitic voltage drops in the inductor discharge path, including synchronous rectifier, inductor, and PC board resistances; V<sub>DROPP2</sub> is the sum of the resistances in the charging path; and T<sub>ON</sub> is the on-time calculated by the RT8206A/B.

**Table 1. TON Setting and PWM Frequency Table**

| TON                         | TON = VCC | TON = REF | TON = GND |
|-----------------------------|-----------|-----------|-----------|
| V <sub>OUT1</sub> K-Factor  | 5μs       | 3.33μs    | 2.5μs     |
| V <sub>OUT1</sub> Frequency | 200kHz    | 300kHz    | 400kHz    |
| V <sub>OUT2</sub> K-Factor  | 4μs       | 2.67μs    | 2μs       |
| V <sub>OUT2</sub> Frequency | 250kHz    | 375kHz    | 500kHz    |
| Approximate K-Factor Error  | ±10%      | ±12.5%    | ±15%      |

**Operation Mode Selection**

The RT8206A/B supports three operation modes: Diode-Emulation Mode, Ultrasonic Mode, and Forced-CCM Mode. Users can set operation mode by  $\overline{\text{SKIP}}$  pin. All of the three operation modes will be introduced as follows.

**Diode-Emulation Mode ( $\overline{\text{SKIP}} = \text{GND}$ )**

In Diode-Emulation mode, the RT8206A/B automatically reduces switching frequency at light load conditions to maintain high efficiency. This reduction of frequency is achieved smoothly and without the increase of  $V_{\text{OUTx}}$  ripple or load regulation. As the output current decreases from heavy load condition, the inductor current is also reduced, and eventually comes to the point that its valley touches zero current, which is the boundary between continuous conduction and discontinuous conduction modes. By emulating the behavior of diodes, the low side MOSFET allows only partial of negative current when the inductor free-wheeling current reach negative. As the load current further decreases, it takes longer and longer to discharge the output capacitor to the level that requires for the next "ON" cycle. The on-time is kept the same as that in the heavy load condition. In reverse, when the output current increases from light load to heavy load, the switching frequency increases to the preset value as the inductor current reaches the continuous conduction. The transition load point to the light load operation can be calculated as following equation.

$$I_{\text{LOAD}} \approx \frac{(V_{\text{IN}} - V_{\text{OUT}})}{2L} \times T_{\text{ON}}$$

where  $T_{\text{ON}}$  is the given On-time.

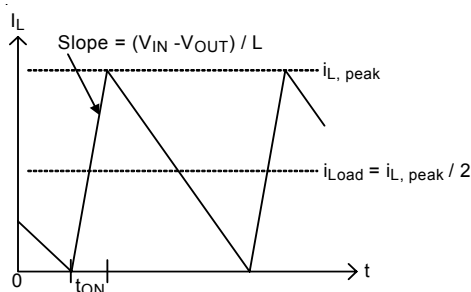

Figure 3. Boundary Condition of CCM/DEM

The switching waveforms may appear noisy and asynchronous when light loading causes Diode-Emulation operation, but this is a normal operating condition that results in high light load efficiency. Trade-offs in PFM noise vs. light load efficiency is made by varying the inductor value. Generally, low inductor values produce a broader efficiency vs. load curve, while higher values result in higher full load efficiency (assuming that the coil resistance remains fixed) and less output voltage ripple. Penalties for using higher inductor values include larger physical size and degraded load transient response (especially at low input voltage levels).

**Ultrasonic Mode ( $\overline{\text{SKIP}} = \text{REF}$ )**

Connecting  $\overline{\text{SKIP}}$  to REF activates a unique Diode-Emulation mode with a minimum switching frequency above 25kHz. This ultrasonic mode eliminates audio-frequency modulation that would otherwise be present when a lightly loaded controller automatically skips pulses. In ultrasonic mode, the low side switch gate driver signal is OR with an internal oscillator (>25kHz). Once the internal oscillator is triggered, the ultrasonic controller forces the LGATEx high, turning on the low side MOSFET to induce a negative inductor current. At the point that the output voltage is higher than that of REF, the controller turns off the low side MOSFET (LGATEx pulled low) and triggers a constant on-time (UGATEx driven high). When the on-time has expired, the controller re-enables the low side MOSFET until the controller detects that the inductor current dropped below the zero crossing threshold.

**Forced-CCM Mode ( $\overline{\text{SKIP}} = V_{\text{CC}}$ )**

The low noise, forced-CCM mode ( $\overline{\text{SKIP}} = V_{\text{CC}}$ ) disables the zero crossing comparator, which controls the low side switch on-time. This causes the low side gate driver waveform to become the complement of the high side gate driver waveform. This in turn causes the inductor current to reverse at light loads as the PWM loop strives to maintain a duty ratio of  $V_{\text{OUT}}/V_{\text{IN}}$ . The benefit of the forced-CCM mode is to keep the switching frequency fairly constant, but it comes at a cost : The no load battery current can be 10mA to 40mA, depending on the external MOSFETs.

## Reference and Linear Regulator (REF, LDO and 14V Charge Pump)

The 2V reference (REF) is accurate within  $\pm 1\%$  over temperature, making REF useful as a precision system reference. Bypass REF to GND with  $0.22\mu\text{F}_{(\text{MIN})}$  capacitor. REF can supply up to  $50\mu\text{A}$  for external loads. Loading REF degrades FBx and output accuracy according to the REF load regulation error.

An internal regulator produces a fixed output voltage 5V. The LDO regulator can supply up to 70mA for external loads. Bypass LDO with a minimum  $4.7\mu\text{F}$  ceramic capacitor. When the output voltage of the  $V_{\text{OUT1}}$  is higher than the switchover threshold, an internal  $1.5\Omega$ -N-Channel MOSFET switch connects  $V_{\text{OUT1}}$  to LDO through BYP while simultaneously shutting down the internal linear regulator.

In typical application circuit figure, the external 14V charge pump is driven by LGATE1. When LGATE1 is low, D1 charge C5 sourced from  $V_{\text{OUT1}}$ . C5 voltage is equal to  $V_{\text{OUT1}}$  minus a diode drop. When LGATE1 transitions to high, the charge from C5 will transfer to C6 through D2 and charge it to  $V_{\text{LGATE1}}$  plus  $V_{\text{C5}}$ . As LGATE1 transients low on the next cycle, C6 will charge C7 to its voltage minus a diode drop through D3. Finally, C7 charges C8 through D4 when LGATE1 transi switched to high. CP output voltage is :

$$CP = V_{\text{OUT1}} + 2 \times V_{\text{LGATE1}} - 4 \times V_{\text{D}}$$

Where :

- ▶  $V_{\text{LGATE1}}$  is the peak voltage of the LGATE1 driver
  - ▶  $V_{\text{D}}$  is the forward diode dropped across the Schottkys
- SECFB (RT8206A) is used to monitor the charge pump through resistive divider. In an event when SECFB drops below 2V, the detection circuit forces the LGATE1 on for 300ns to allow CP to recharge and the SECFB rise above 2V. In the event of an overload on CP where SECFB can not reach more than 2V, the monitor will be deactivated.

The SECFB pin has a 17mV of hysteresis so the ripple should be enough to bring the SECFB voltage above the threshold by  $\sim 3x$  the hysteresis, or  $(3 \times 17\text{mV}) = 51\text{mV}$ . Reducing the CP decoupling capacitor and placing a small ceramic capacitor C19 ( $10\text{pF}$  to  $47\text{pF}$ ) in parallel will the upper leg of the SECFB resistor feedback network (R11

of Figure 3), will also increase the robustness of the charge pump.

## Current Limit Setting (ILIMx)

The RT8206A/B has a cycle-by-cycle current limiting control. The current-limit circuit employs a unique “valley” current sensing algorithm. If the magnitude of the current sense signal at PHASEx is above the current limit threshold, the PWM is not allowed to initiate a new cycle (Figure 4). The actual peak current is greater than the current limit threshold by an amount equal to the inductor ripple current. Therefore, the exact current limit characteristic and maximum load capability are a function of the sense resistance, inductor value, battery voltage, and output voltage.

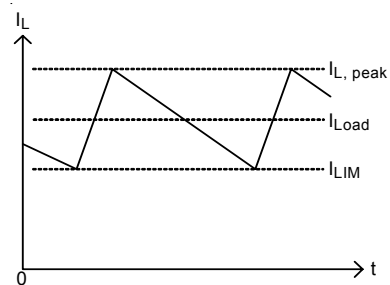

Figure 4. Valley Current Limit

The RT8206A/B uses the on-resistance of the synchronous rectifier as the current sense element. Use the worst-case maximum value for  $R_{\text{DS(ON)}}$  from the MOSFET datasheet, and add a margin of  $0.5\%/^{\circ}\text{C}$  for the rise in  $R_{\text{DS(ON)}}$  with temperature.

The current limit threshold is adjusted with an external resistor for the RT8206A/B at ILIMx. The current limit threshold adjustment range is from 50mV to 200mV. In the adjustment mode, the current limit threshold voltage is precise to 1/10 the voltage seen at ILIMx. The threshold defaults to 100mV when ILIMx is connected to VCC. The logic threshold for switchover to the 100mV default value is higher than  $V_{\text{CC}} - 1\text{V}$ .

Carefully observe the PC board layout guidelines to ensure that noise and DC errors do not corrupt the current sense signal at PHASEx and GND. Mount or place the IC close to the low side MOSFET.

**MOSFET Gate Driver (UGATEx, LGATEx)**

The high side driver is designed to drive high current, low  $R_{DS(ON)}$  N-MOSFET(s). When configured as a floating driver the instantaneous drive current is supplied by the flying capacitor between BOOTx and PHASEx pins. A dead time to prevent shoot through is internally generated between high side MOSFET off to low side MOSFET on, and low side MOSFET off to high side MOSFET on.

The low side driver is designed to drive high current low  $R_{DS(ON)}$  N-MOSFET(s). The internal pulldown transistor that drives LGATEx low is robust, with a  $0.6\Omega$  typical on-resistance. A 5V bias voltage is typically delivered from PVCC through LDO supply. The instantaneous drive current is supplied by an input capacitor connected between PVCC and GND.

For high current applications, some combinations of high and low side MOSFETs might be encountered that will cause excessive gate drain coupling, which can lead to efficiency killing, EMI-producing shoot-through currents. This is often remedied by adding a resistor in series with BOOTx, which increases the turn-on time of the high side MOSFET without degrading the turn-off time (Figure 5).

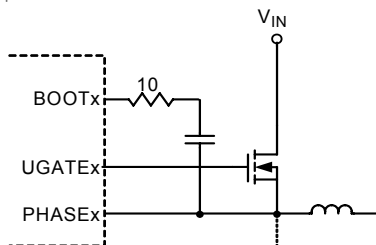

Figure 5. Reducing the UGATEx Rise Time

**Soft-Start**

A built-in soft-start is used to prevent surge current from power supply input after ENx is enabled. The typical soft-start duration is 2ms period. The maximum allowed current limit is segmented in 5 steps : 20%, 40%, 60%, 80% and 100% during this period. The current limit steps can eliminate the  $V_{OUT}$  folded-back in the soft-start duration.

**POR and UVLO**

Power On Reset (POR) occurs when VIN rises above approximately 3.7V (typ.), resetting the fault latches. PVCC Under Voltage Lockout (UVLO) circuitry inhibits

switching by keeping UGATEx and LGATEx low when PVCC is below 4V. The PWM outputs begin to ramp up once PVCC exceeds its UVLO threshold and ENx is enable.

**Power Good Output (PGOODx)**

The PGOODx is an open-drain type output. PGOODx is actively held low in soft-start, standby, and shutdown. It is released when the VOUTx voltage is above than 92.5% of the nominal regulation point. The PGOODx goes low if it is 7.5% below its nominal regulator point.

**Output Over voltage Protection (OVP)**

The output voltage can be continuously monitored for over voltage protection. When the output voltage of the VOUTx is 11% above the set voltage, over voltage protection will be enabled, if the output exceeds the over voltage threshold, over voltage fault protection will be triggered and the LGATEx low side gate drivers are forced high. This activates the low side MOSFET switch, which rapidly discharges the output capacitor and reduces the output voltage. Once an over voltage fault condition is set, it can only be reset by toggling ENLDO, ENx, or cycling VIN (POR.)

**Output Under Voltage Protection (UVP)**

The output voltage can be continuously monitored for under voltage protection. If the output is less than 70% of the error amplifier trip voltage, under voltage protection will be triggered, and then both UGATEx and LGATEx gate drivers will be forced low. The UVP will be ignored for at least 3ms (typ.) after start-up or after a rising edge on ENx. Toggle ENx or cycle VIN (POR) to clear the under voltage fault latch and restart the controller. The UVP only applies to the BUCK outputs.

**Thermal Protection**

The RT8206A/B has a thermal shutdown protection function to prevent it from overheating. Thermal shutdown occurs when the die temperature exceeds 150°C. All internal circuitry will be shut down during thermal shutdown. The RT8206A/B may trigger thermal shutdown if the LDO were not supplied from VOUTx, while input voltage is on VIN and drawing current that is too high from the LDO. Even if the LDO is supplied from VOUTx, overloading the

LDO causes large power dissipation on automatic switches, which may result in thermal shutdown.

### Discharge Mode

When standby or shutdown mode occurs, or the output under voltage fault latch is set, the outputs discharge mode is triggered. During discharge mode, the output capacitor will be discharged to GND through an internal 20Ω switch.

### Shutdown Mode

The RT8206A/B SMPS1, SMPS2 and LDO have independent enabling control. Drive ENLDO, EN1 and EN2 below the precise input falling edge trip level to place the RT8206A/B in its low power shutdown state. The RT8206A/B consumes only 20μA of quiescent current while in shutdown. When shutdown mode is activated, the reference turns off. The accurate 1V falling-edge threshold on the ENLDO can be used to detect a specific analog voltage level and shutdown the device. Once in shutdown, the 1.6V rising edge threshold activates, providing sufficient hysteresis for most application.

### Power Up Sequencing and On/Off Controls (ENx)

EN1 and EN2 control SMPS power up sequencing. When the RT8206A/B applies in the single channel mode, EN1 or EN2 enables the respective outputs when ENx voltage rising above 2.5V, and disables the respective outputs when ENx voltage falling below 1.8V.

Connecting one of ENx to VCC and the other one to REF can force the latter one output starts after the former one regulates.

If both of ENx forced to connect to REF, both outputs will always wait for the regulation of the other one. However, in this situation, neither of the two ENx will be in regulation.

### Output Voltage Setting (FBx)

Connect FB1 directly to GND or VCC for a fixed 5V output (VOUT1). Connect FB2 directly to GND or VCC for a fixed 3.3V output (VOUT2).

The output voltage can also be adjusted from 2V to 5.5V with a resistor divider network (Figure 6). The following equation is for adjusting the output voltage. Choose R2 to be approximately 10kΩ, and solve for R1 using the following equation :

$$V_{OUTx} = V_{FBx} \times \left[ 1 + \left( \frac{R1}{R2} \right) \right]$$

Where  $V_{FBx}$  is 2V (typ.).

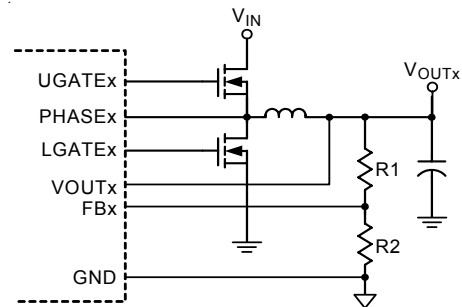

Figure 6. Setting VOUTx with a Resistor Divider

### Output Inductor Selection

The switching frequency (on-time) and operating point (% ripple or LIR) determine the inductor value as follows :

$$L = \frac{T_{ON} \times (V_{IN} - V_{OUT})}{LIR \times I_{LOAD(MAX)}}$$

Where LIR is the ratio of the peak-to-peak ripple current to the average inductor current.

Find a low loss inductor having the lowest possible DC resistance that fits in the allotted dimensions. Ferrite cores are often the best choice, although the powdered iron is inexpensive and can work well at 200kHz. The core must be large enough to prevent it from saturating at the peak inductor current ( $I_{PEAK}$ ) :

$$I_{PEAK} = I_{LOAD(MAX)} + [(LIR / 2) \times I_{LOAD(MAX)}]$$

This inductor ripple current also impacts transient-response performance, especially at low  $V_{IN} - V_{OUTx}$  differences. Low inductor values allow the inductor current to slew faster, replenishing charge removed from the output filter capacitors by a sudden load step. The peak amplitude of the output transient. The  $V_{SAG}$  also features a function of the output transient ( $V_{SAG}$ ) is also a function of the maximum duty factor, which can be calculated from the on-time and minimum off-time :

$$V_{SAG} = \frac{(\Delta I_{LOAD})^2 \times L \times \left( K \frac{V_{OUTx}}{V_{IN}} + T_{OFF(MIN)} \right)}{2 \times C_{OUT} \times V_{OUTx} \times \left[ K \left( \frac{V_{IN} - V_{OUTx}}{V_{IN}} \right) - T_{OFF(MIN)} \right]}$$

Where minimum off-time ( $T_{OFF(MIN)}$ ) = 300ns (typ.) and K is from Table 1.

**Output Capacitor Selection**

The output filter capacitor must have low enough Equivalent Series Resistance (ESR) to meet output ripple and load transient requirements, yet have high enough ESR to satisfy stability requirements. The output capacitance must also be high enough to absorb the inductor energy while transiting from full load to no load conditions without tripping the overvoltage fault latch.

Although Mach Response™ DRV™ dual ramp valley mode provides many advantages such as ease-of-use, minimum external component configuration, and extremely short response time, due to not employing an error amplifier in the loop, a sufficient feedback signal needs to be provided by an external circuit to reduce the jitter level. The required signal level is approximately 15mV at the comparing point. This generates  $V_{RIPPLE} = (V_{OUT} / 2) \times 15mV$  at the output node. The output capacitor ESR should meet this requirement.

**Output Capacitor Stability**

Stability is determined by the value of the ESR zero relative to the switching frequency. The point of instability is given by the following equation :

$$f_{ESR} = \frac{1}{2 \times \pi \times ESR \times C_{OUT}} \leq \frac{f_{SW}}{4}$$

Do not put high-value ceramic capacitors directly across the outputs without taking precautions to ensure stability. Large ceramic capacitors can have a high ESR zero frequency and cause erratic, unstable operation. However, it is easy to add enough series resistance by placing the capacitors a couple of inches downstream from the inductor and connecting VOUTx or the FBx divider close to the inductor.

There are two related but distinct ways including double-pulsing and feedback loop instability in the unstable operation.

Double-pulsing occurs due to noise on the output or because the ESR is too low that there is not enough voltage ramp in the output voltage signal. This “fools” the error comparator into triggering a new cycle immediately after the 300ns minimum off-time period has expired. Double-pulsing is more annoying than harmful, resulting in nothing worse than increased output ripple.

However, it may indicate the possible presence of loop instability, which is caused by insufficient ESR.

Loop instability can result in oscillations at the output after line or load perturbations that can trip the over voltage protection latch or cause the output voltage to fall below the tolerance limit.

The easiest method for checking stability is to apply a very fast zero-to-max load transient and carefully observe the output voltage ripple envelope for overshoot and ringing. It helps to simultaneously monitor the inductor current with an AC current probe. Do not allow more than one cycle of ringing after the initial step response under or overshoot.

**Thermal Considerations**

For continuous operation, do not exceed absolute maximum operation junction temperature. The maximum power dissipation depends on the thermal resistance of IC package, PCB layout, the rate of surroundings airflow and temperature difference between junction to ambient. The maximum power dissipation can be calculated by following formula :

$$P_{D(MAX)} = ( T_{J(MAX)} - T_A ) / \theta_{JA}$$

Where  $T_{J(MAX)}$  is the maximum operation junction temperature,  $T_A$  is the ambient temperature and the  $\theta_{JA}$  is the junction to ambient thermal resistance.

For recommended operating conditions specification of RT8206, the maximum junction temperature is 125°C. The junction to ambient thermal resistance  $\theta_{JA}$  is layout dependent. For WQFN-32L 5x5 package, the thermal resistance  $\theta_{JA}$  is 36°C/W on the standard JEDEC 51-7 four layers thermal test board. The maximum power dissipation at  $T_A = 25^\circ C$  can be calculated by following formula :

$$P_{D(MAX)} = (125^\circ C - 25^\circ C) / (36^\circ C/W) = 2.778W \text{ for WQFN-32L 5x5 package}$$

The maximum power dissipation depends on operating ambient temperature for fixed  $T_{J(MAX)}$  and thermal resistance  $\theta_{JA}$ . For RT8206A/B package, the Figure 7 of derating curves allows the designer to see the effect of rising ambient temperature on the maximum power allowed.

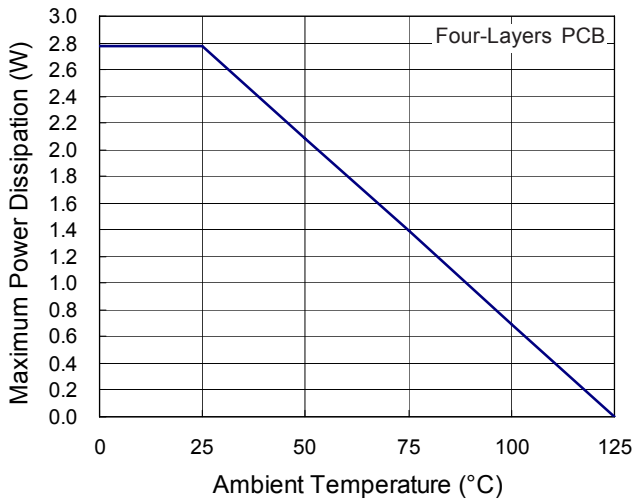

Figure 7. Derating Curves for RT8206A/B Package

**Layout Considerations**

Layout is very important in high frequency switching converter design. If the layout is designed improperly, the PCB could radiate excessive noise and contribute to the converter instability. The following points must be followed for a proper layout of RT8206A/B.

- ▶ Connect RC low pass filter from PVCC to VCC, the RC low pass filter is composed of an external capacitor and an internal 10Ω resistor. Bypass VCC to GND with a capacitor 1μF is recommended. Place the capacitor close to the IC, within 12mm (0.5 inch) if possible.
- ▶ Keep current limit setting network as close as possible to the IC. Routing of the network should avoid coupling to high voltage switching node.
- ▶ Connections from the drivers to the respective gate of the high side or the low side MOSFET should be as short as possible to reduce stray inductance. Use 0.65mm (25 mils) or wider trace.
- ▶ All sensitive analog traces and components such as VOUTx, FBx, GND, ENx, PGOODx, ILIMx, VCC, and

TON should be placed away from high voltage switching nodes such as PHASEx, LGATEx, UGATEx or BOOTx nodes to avoid coupling. Use internal layer(s) as ground plane(s) and shield the feedback trace from power traces and components.

- ▶ Gather ground terminal of VIN capacitor(s), VOUTx capacitor(s), and source of low side MOSFETs as close as possible. PCB trace defined as PHASEx node, which connects to source of high side MOSFET, drain of low side MOSFET and high voltage side of the inductor, should be as short and wide as possible.



**Table 2. Operation Mode Truth Table**

| Mode                     | Condition  | Comment   |
|--------------------------|--|---|
| Power UP                 | PVCC < UVLO threshold  | Transitions to discharge mode after a VIN POR and after REF becomes valid. LDO and REF remain active.   |
| RUN                      | ENLDO = high, EN1 or EN2 enabled   | Normal Operation.   |
| Over voltage Protection  | Either output > 111% of nominal level.   | LGATE <sub>x</sub> is forced high. LDO and REF active. Exited by VIN POR or by toggling ENLDO.  |
| Under voltage Protection | Either output < 70% of nominal level after 3ms time-out expires and output is enabled. | Both UGATE <sub>x</sub> and LGATE <sub>x</sub> are forced low until enter discharge mode terminates. LDO and REF are active. Exited by VIN POR or by toggling ENLDO, EN1, or EN2. |
| Discharge                | Either SMPS output is still high in either standby mode or shutdown mode.              | During discharge mode, the output capacitor discharges to GND through an internal 20Ω switch.   |
| Standby                  | EN <sub>x</sub> < startup threshold, ENLDO = high.                                     | LGATE <sub>x</sub> stays low. LDO and REF active.   |
| Shutdown                 | EN1, EN2, ENLDO=low  | All circuitry off.  |
| Thermal Shutdown         | T <sub>J</sub> > +150°C  | All circuitry off. Exit by VIN POR or by toggling ENLDO.  |

**Table 3. Power Up Sequencing**

| ENLDO (V)  | V <sub>EN1</sub> (V) | V <sub>EN2</sub> (V) | LDO                         | 5V SMPS1               | 3V SMPS2               |
|------------|----------------------|----------------------|-----------------------------|------------------------|------------------------|
| Low        | X                    | X                    | Off                         | Off                    | Off                    |
| ">2V" High | Low                  | Low                  | On<br>(after REF powers up) | Off                    | Off                    |
| ">2V" High | Low                  | REF                  | On<br>(after REF powers up) | Off                    | Off                    |
| ">2V" High | Low                  | High                 | On<br>(after REF powers up) | Off                    | On                     |
| ">2V" High | REF                  | Low                  | On<br>(after REF powers up) | Off                    | Off                    |
| ">2V" High | REF                  | REF                  | On<br>(after REF powers up) | Off                    | Off                    |
| ">2V" High | REF                  | High                 | On<br>(after REF powers up) | On<br>(after SMPS2 on) | On                     |
| ">2V" High | High                 | Low                  | On<br>(after REF powers up) | On                     | Off                    |
| ">2V" High | High                 | REF                  | On<br>(after REF powers up) | On                     | On<br>(after SMPS1 on) |
| ">2V" High | High                 | High                 | On<br>(after REF powers up) | On                     | On                     |

Outline Dimension

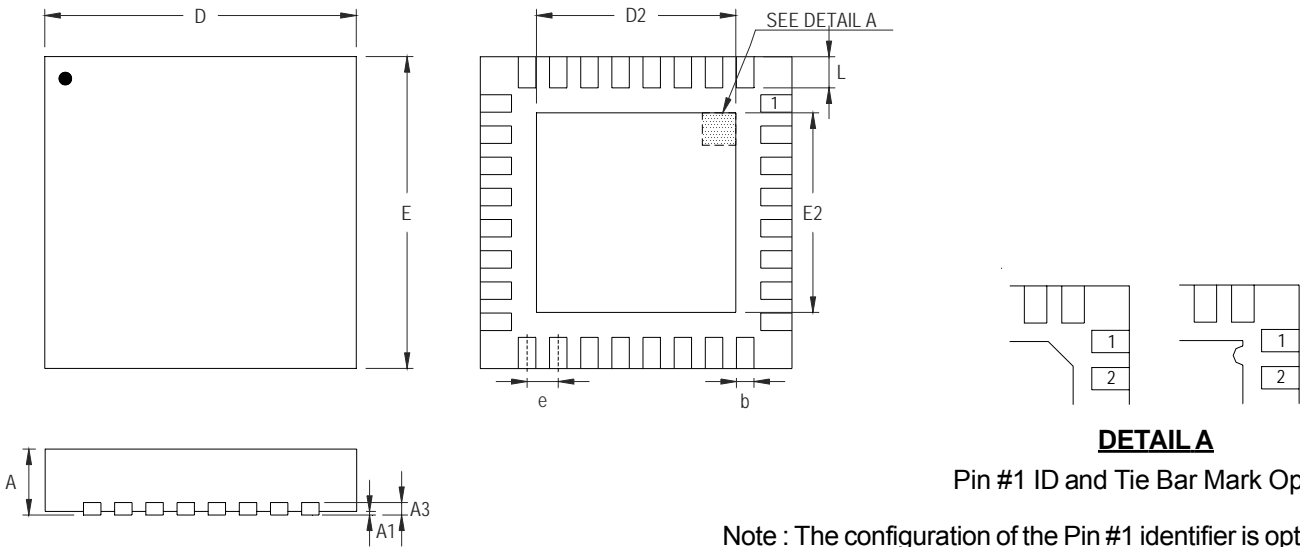

**DETAIL A**

Pin #1 ID and Tie Bar Mark Options

Note : The configuration of the Pin #1 identifier is optional, but must be located within the zone indicated.

| Symbol | Dimensions In Millimeters |       | Dimensions In Inches |       |
|--------|---------------------------|-------|----------------------|-------|
|        | Min                       | Max   | Min                  | Max   |
| A      | 0.700                     | 0.800 | 0.028                | 0.031 |
| A1     | 0.000                     | 0.050 | 0.000                | 0.002 |
| A3     | 0.175                     | 0.250 | 0.007                | 0.010 |
| b      | 0.180                     | 0.300 | 0.007                | 0.012 |
| D      | 4.950                     | 5.050 | 0.195                | 0.199 |
| D2     | 3.400                     | 3.750 | 0.134                | 0.148 |
| E      | 4.950                     | 5.050 | 0.195                | 0.199 |
| E2     | 3.400                     | 3.750 | 0.134                | 0.148 |
| e      | 0.500                     |       | 0.020                |       |
| L      | 0.350                     | 0.450 | 0.014                | 0.018 |

**W-Type 32L QFN 5x5 Package**

**Richtek Technology Corporation**

Headquarter  
 5F, No. 20, Taiyuen Street, Chupei City  
 Hsinchu, Taiwan, R.O.C.  
 Tel: (8863)5526789 Fax: (8863)5526611

**Richtek Technology Corporation**

Taipei Office (Marketing)  
 5F, No. 95, Minchiuan Road, Hsintien City  
 Taipei County, Taiwan, R.O.C.  
 Tel: (8862)86672399 Fax: (8862)86672377  
 Email: marketing@richtek.com

Information that is provided by Richtek Technology Corporation is believed to be accurate and reliable. Richtek reserves the right to make any change in circuit design, specification or other related things if necessary without notice at any time. No third party intellectual property infringement of the applications should be guaranteed by users when integrating Richtek products into any application. No legal responsibility for any said applications is assumed by Richtek.