

Optocoupler, Phototransistor Output, Low Input Current

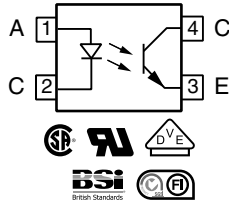
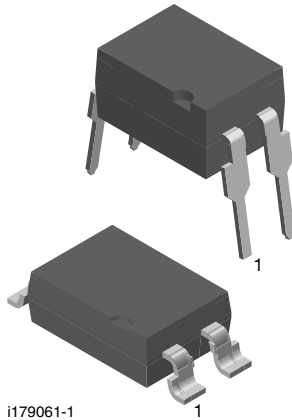

FEATURES

- Good CTR linearity depending on forward current
- Low CTR degradation
- High collector emitter voltage, $V_{CE0} = 55\text{ V}$
- Isolation test voltage, 5300 V_{RMS}
- Low coupling capacitance
- End stackable, 0.100" (2.54 mm) spacing
- High common mode transient immunity
- Material categorization: for definitions of compliance please see www.vishay.com/doc?99912

RoHS
COMPLIANT

APPLICATIONS

- Telecom
- Industrial controls
- Battery powered equipment
- Office machines

AGENCY APPROVALS

The safety application model number covering all products in this datasheet is SFH618A. This model number should be used when consulting safety agency documents.

- UL1577
- cUL
- CSA
- DIN EN 60747-5-5 (VDE 0884-5) available with option 1
- BSI
- FIMKO

DESCRIPTION

The SFH618A (DIP) and SFH6186 (SMD) feature a high current transfer ratio, low coupling capacitance and high isolation voltage. These couplers have a GaAs infrared diode emitter, which is optically coupled to silicon planar phototransistor detector, and is incorporated in a plastic DIP-4 or SMD package.

The coupling devices are designed for signal transmission between two electrically separated circuits. The couplers are end-stackable with 2.54 mm lead spacing. Creepage and clearance distances of > 8 mm achieved with option 6.

ORDERING INFORMATION

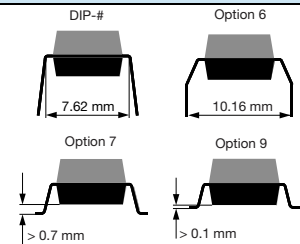
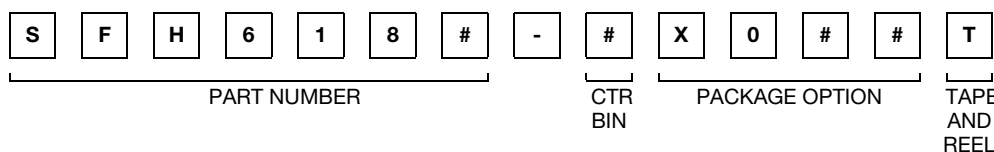

AGENCY CERTIFIED/PACKAGE	CTR (%)			
	1 mA			
UL, cUL	63 to 125	100 to 200	160 to 320	250 to 500
DIP-4	SFH618A-2	SFH618A-3	SFH618A-4	SFH618A-5
DIP-4, 400 mil, option 6	-	SFH618A-3X006	-	-
SMD-4, option 7	-	-	-	SFH618A-5X007T ⁽¹⁾
SMD-4, option 9	SFH6186-2T ⁽¹⁾	SFH6186-3T ⁽¹⁾ , SFH6186-3T1	SFH6186-4T ⁽¹⁾	SFH6186-5T ⁽¹⁾ , SFH6186-5T1
VDE, UL, cUL	63 to 125	100 to 200	160 to 320	250 to 500
DIP-4	-	SFH618A-3X001	SFH618A-4X001	-
DIP-4, 400 mil, option 6	-	SFH618A-3X016	SFH618A-4X016	SFH618A-5X016
SMD-4, option 7	-	SFH618A-3X017T ⁽¹⁾	-	SFH618A-5X017T ⁽¹⁾
SMD-4, option 9	-	SFH6186-3X001T ⁽¹⁾ , SFH6186-3X001T1	SFH6186-4X001T	SFH6186-5X001T ⁽¹⁾

Notes

- Additional options may be possible, please contact sales office
- ⁽¹⁾ Also available in tubes, do not put T to the end



ABSOLUTE MAXIMUM RATINGS (T _{amb} = 25 °C, unless otherwise specified)				
PARAMETER	TEST CONDITION	SYMBOL	VALUE	UNIT
INPUT				
Reverse voltage		V _R	6	V
Power dissipation		P _{diss}	70	mW
Forward current		I _F	60	mA
OUTPUT				
Collector emitter voltage		V _{CEO}	55	V
Emitter collector voltage		V _{ECO}	7	V
Collector current		I _C	50	mA
	t _p ≤ 1 ms	I _C	100	mA
Power dissipation		P _{diss}	150	mW
COUPLER				
Storage temperature range		T _{stg}	-55 to +150	°C
Ambient temperature range		T _{amb}	-55 to +100	°C
Junction temperature		T _j	125	°C
Soldering temperature	max. 10 s, dip soldering distance to seating plane ≥ 1.5 mm	T _{sld}	260	°C

Note

- Stresses in excess of the absolute maximum ratings can cause permanent damage to the device. Functional operation of the device is not implied at these or any other conditions in excess of those given in the operational sections of this document. Exposure to absolute maximum ratings for extended periods of the time can adversely affect reliability

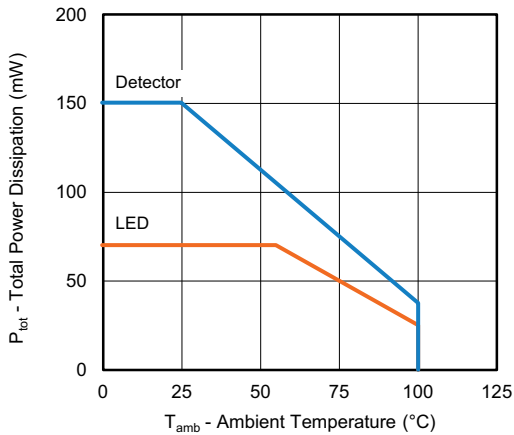

Fig. 1 - Permissible Power Dissipation vs. Ambient Temperature



ELECTRICAL CHARACTERISTICS ($T_{amb} = 25\text{ }^{\circ}\text{C}$, unless otherwise specified)							
PARAMETER	TEST CONDITION	PART	SYMBOL	MIN.	TYP.	MAX.	UNIT
INPUT							
Forward voltage	$I_F = 5\text{ mA}$		V_F	-	1.1	1.5	V
Reverse current	$V_R = 6\text{ V}$		I_R	-	0.01	10	μA
Capacitance	$V_R = 0\text{ V}, f = 1\text{ MHz}$		C_O	-	25	-	pF
Thermal resistance			R_{thja}	-	1070	-	K/W
OUTPUT							
Collector emitter leakage current	$V_{CE} = 10\text{ V}$		I_{CEO}	-	10	200	nA
Collector emitter capacitance	$V_{CE} = 5\text{ V}, f = 1\text{ MHz}$		C_{CE}	-	7	-	pF
Thermal resistance			R_{thja}	-	500	-	K/W
COUPLER							
Collector emitter saturation voltage	$I_C = 0.32\text{ mA}, I_F = 1\text{ mA}$	SFH618A-2	V_{CEsat}	-	0.25	0.4	V
		SFH6186-2	V_{CEsat}	-	0.25	0.4	V
	$I_C = 0.5\text{ mA}, I_F = 1\text{ mA}$	SFH618A-3	V_{CEsat}	-	0.25	0.4	V
		SFH6186-3	V_{CEsat}	-	0.25	0.4	V
	$I_C = 0.8\text{ mA}, I_F = 1\text{ mA}$	SFH618A-4	V_{CEsat}	-	0.25	0.4	V
		SFH6186-4	V_{CEsat}	-	0.25	0.4	V
	$I_C = 1.25\text{ mA}, I_F = 1\text{ mA}$	SFH618A-5	V_{CEsat}	-	0.25	0.4	V
		SFH6186-5	V_{CEsat}	-	0.25	0.4	V
Coupling capacitance			C_C	-	0.25	-	pF

Note

- Minimum and maximum values are testing requirements. Typical values are characteristics of the device and are the result of engineering evaluation. Typical values are for information only and are not part of the testing requirements

CURRENT TRANSFER RATIO ($T_{amb} = 25\text{ }^{\circ}\text{C}$, unless otherwise specified)							
PARAMETER	TEST CONDITION	PART	SYMBOL	MIN.	TYP.	MAX.	UNIT
I_C/I_F	$I_F = 1\text{ mA}, V_{CE} = 0.5\text{ V}$	SFH618A-2	CTR	63	-	125	%
		SFH6186-2	CTR	63	-	125	%
	$I_F = 0.5\text{ mA}, V_{CE} = 1.5\text{ V}$	SFH618A-2	CTR	32	75	-	%
		SFH6186-2	CTR	32	75	-	%
	$I_F = 1\text{ mA}, V_{CE} = 0.5\text{ V}$	SFH618A-3	CTR	100	-	200	%
		SFH6186-3	CTR	100	-	200	%
	$I_F = 0.5\text{ mA}, V_{CE} = 1.5\text{ V}$	SFH618A-3	CTR	50	120	-	%
		SFH6186-3	CTR	50	120	-	%
	$I_F = 1\text{ mA}, V_{CE} = 0.5\text{ V}$	SFH618A-4	CTR	160	-	320	%
		SFH6186-4	CTR	160	-	320	%
	$I_F = 0.5\text{ mA}, V_{CE} = 1.5\text{ V}$	SFH618A-4	CTR	80	200	-	%
		SFH6186-4	CTR	80	200	-	%
	$I_F = 1\text{ mA}, V_{CE} = 0.5\text{ V}$	SFH618A-5	CTR	250	-	500	%
		SFH6186-5	CTR	250	-	500	%
	$I_F = 0.5\text{ mA}, V_{CE} = 1.5\text{ V}$	SFH618A-5	CTR	125	300	-	%
		SFH6186-5	CTR	125	300	-	%

SWITCHING CHARACTERISTICS ($T_{amb} = 25\text{ }^{\circ}\text{C}$, unless otherwise specified)							
PARAMETER	TEST CONDITION	SYMBOL	MIN.	TYP.	MAX.	UNIT	
Turn on time	$V_{CC} = 5\text{ V}, I_C = 2\text{ mA}, R_L = 100\text{ }\Omega$	t_{on}	-	6	-	μs	
Rise time	$V_{CC} = 5\text{ V}, I_C = 2\text{ mA}, R_L = 100\text{ }\Omega$	t_r	-	3.5	-	μs	
Turn off time	$V_{CC} = 5\text{ V}, I_C = 2\text{ mA}, R_L = 100\text{ }\Omega$	t_{off}	-	5.5	-	μs	
Fall time	$V_{CC} = 5\text{ V}, I_C = 2\text{ mA}, R_L = 100\text{ }\Omega$	t_f	-	5	-	μs	

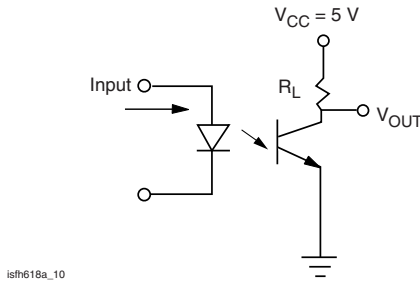

Fig. 2 - Test Circuit

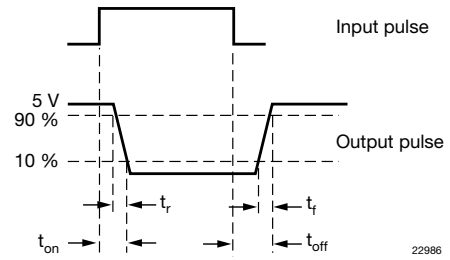

Fig. 3 - Parameter and Limit Definition

SAFETY AND INSULATION RATINGS				
PARAMETER	TEST CONDITION	SYMBOL	VALUE	UNIT
Climatic classification	According to IEC 68 part 1		55 / 115 / 21	
Pollution degree	According to DIN VDE 0109		2	
Comparative tracking index	Insulation group IIIa	CTI	175	
Maximum rated withstanding isolation voltage	According to UL1577, t = 1 min	V_{ISO}	4470	V_{RMS}
Tested withstanding isolation voltage	According to UL1577, t = 1 s	V_{ISO}	5300	V_{RMS}
Maximum transient isolation voltage	According to DIN EN 60747-5-5	V_{IOTM}	8000	V_{peak}
Maximum repetitive peak isolation voltage	According to DIN EN 60747-5-5	V_{IORM}	890	V_{peak}
Isolation resistance	$T_{amb} = 25\text{ }^{\circ}\text{C}$, $V_{IO} = 500\text{ V}$	R_{IO}	$\geq 10^{12}$	Ω
	$T_{amb} = 100\text{ }^{\circ}\text{C}$, $V_{IO} = 500\text{ V}$	R_{IO}	$\geq 10^{11}$	Ω
Output safety power		P_{SO}	700	mW
Input safety current		I_{SI}	400	mA
Input safety temperature		T_S	175	$^{\circ}\text{C}$
Creepage distance	DIP-4		≥ 7	mm
Clearance distance			≥ 7	mm
Creepage distance	DIP-4, 400 mil, option 6		≥ 8	mm
Clearance distance			≥ 8	mm
Creepage distance	SMD-4, option 7 and option 9		≥ 7	mm
Clearance distance			≥ 7	mm
Insulation thickness		DTI	≥ 0.4	mm

Note

- As per DIN EN 60747-5-5, § 7.4.3.8.2, this optocoupler is suitable for “safe electrical insulation” only within the safety ratings. Compliance with the safety ratings shall be ensured by means of protective circuits

TYPICAL CHARACTERISTICS ($T_{amb} = 25\text{ }^{\circ}\text{C}$, unless otherwise specified)

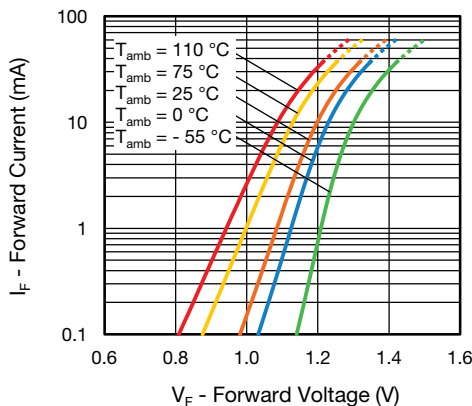

Fig. 4 - Forward Voltage vs. Forward Current

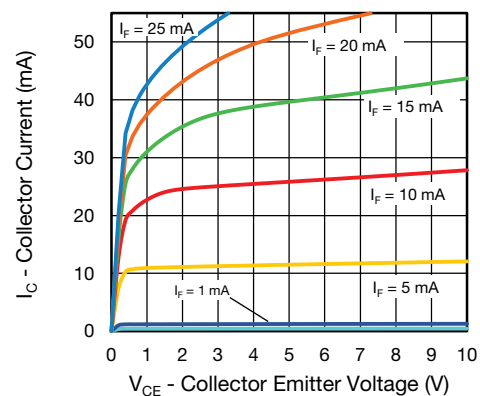

Fig. 5 - Collector Current vs. Collector Emitter Voltage

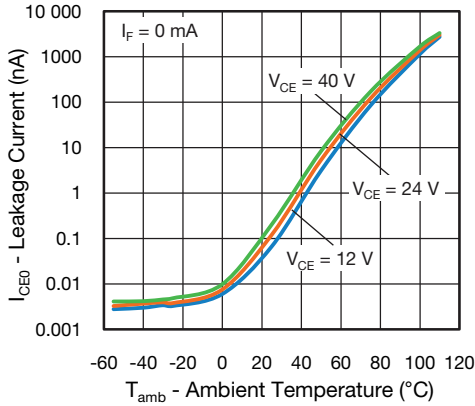

Fig. 6 - Collector Emitter Current vs. Ambient Temperature

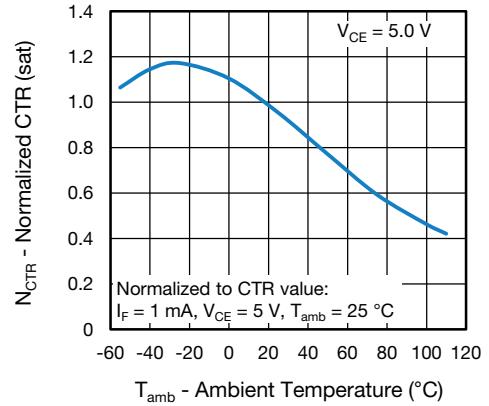

Fig. 9 - Normalized Current Transfer Ratio vs. Ambient Temperature (sat.)

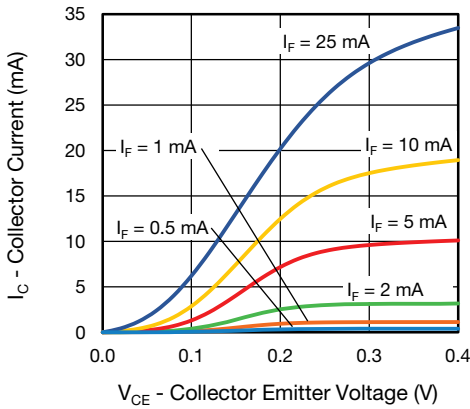

Fig. 7 - Collector Current vs. Collector Emitter Voltage

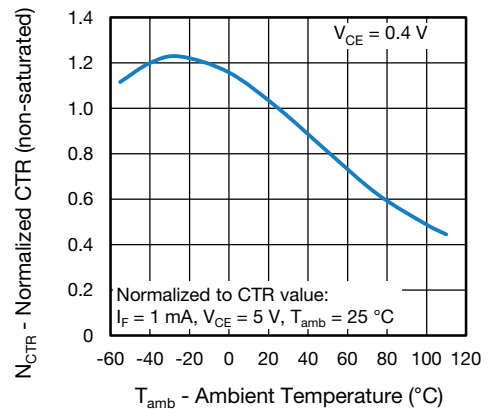

Fig. 10 - Normalized Current Transfer Ratio vs. Ambient Temperature (non-sat.)

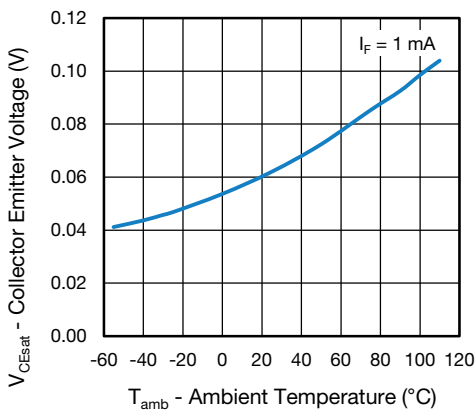

Fig. 8 - Collector Emitter Voltage vs. Ambient Temperature

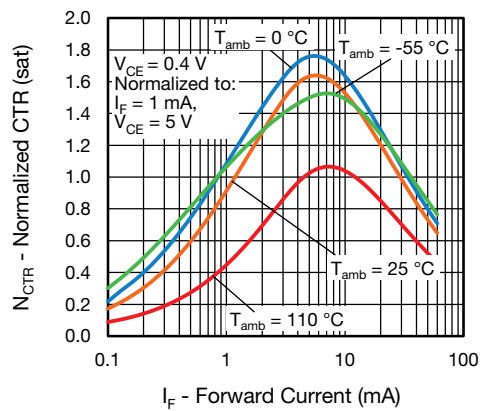

Fig. 11 - Current Transfer Ratio vs. Forward Current (sat.)

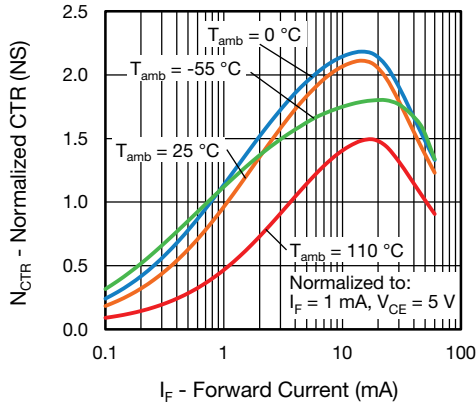

Fig. 12 - Current Transfer Ratio vs. Forward Current (non-sat.)

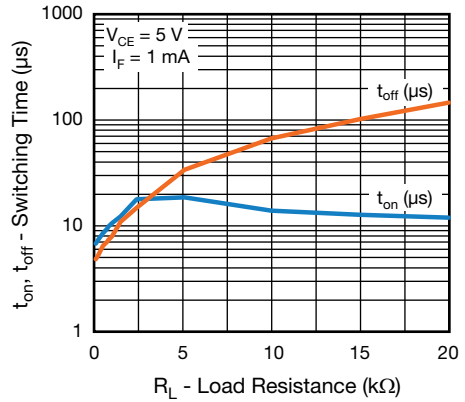

Fig. 15 - Switching Time vs. Load Resistance

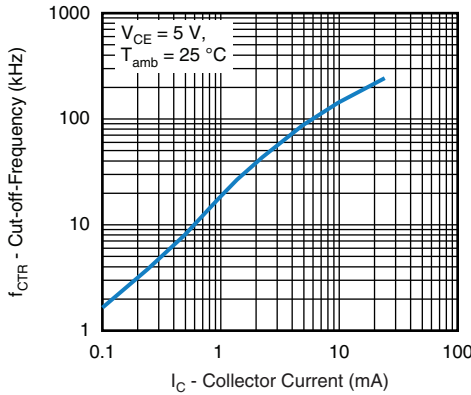

Fig. 13 - Cut-Off Frequency vs. Collector Current

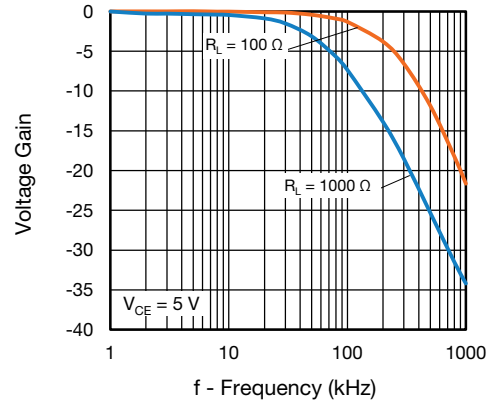

Fig. 16 - Voltage Gain vs. Frequency

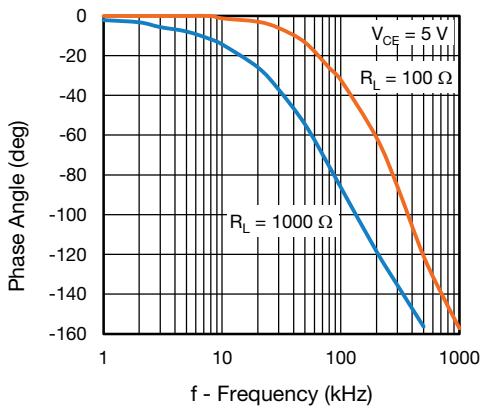
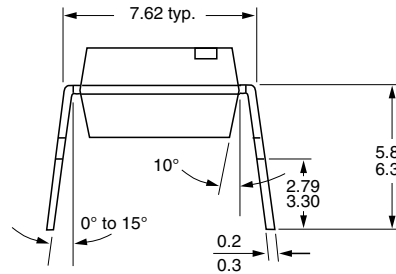
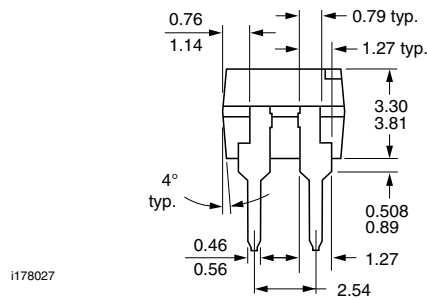
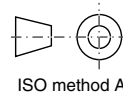
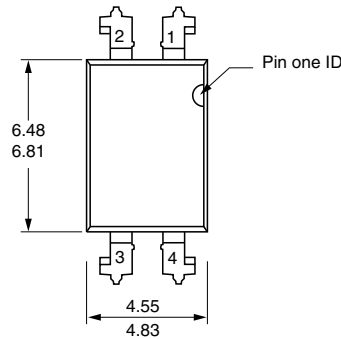

Fig. 14 - Phase Angle vs. Frequency



PACKAGE DIMENSIONS (in millimeters)



i178027

SMD

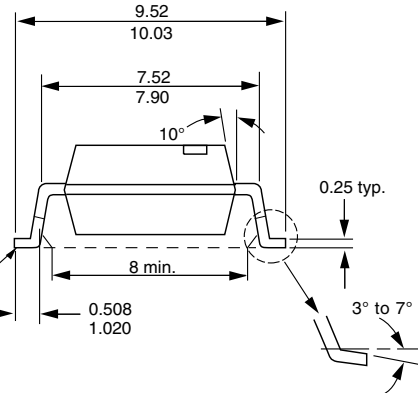
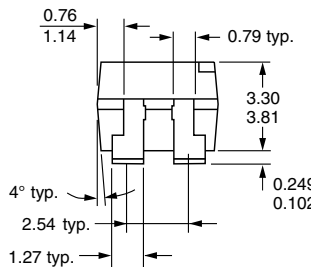
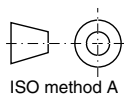
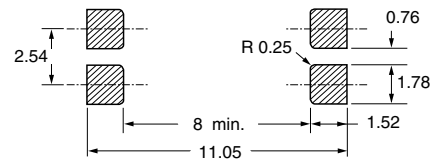
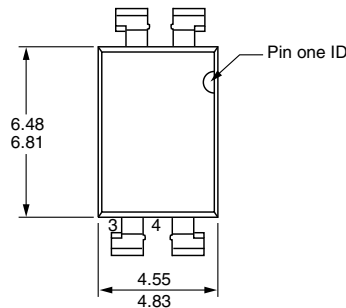

Lead coplanarity 0.004 max.

i178029

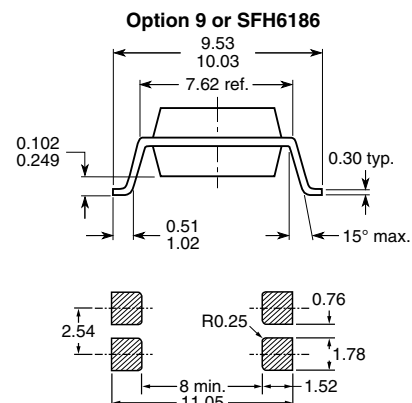
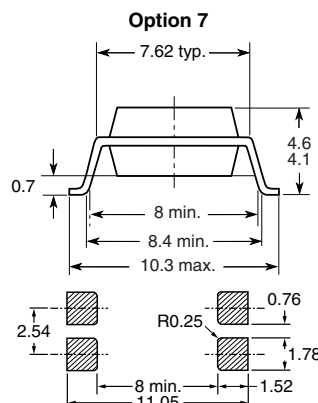
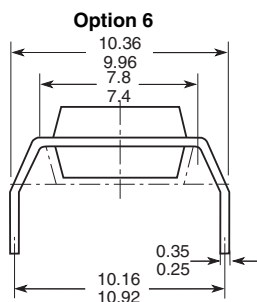

18450-11

PACKAGE MARKING (example of SFH618A-3X001)

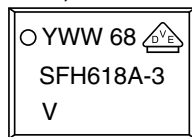

Notes

- VDE logo is only marked on option 1 parts
- Tape and reel suffix (T) is not part of the package marking

TAPE AND REEL PACKAGING (in millimeters)

The tape is 16 mm and is wound on a 33 cm reel. There are 1000 parts per reel. Taped and reeled 4 pin optocouplers conform to EIA-481-2 and IEC60286-3.

SMD-4 (“T”)

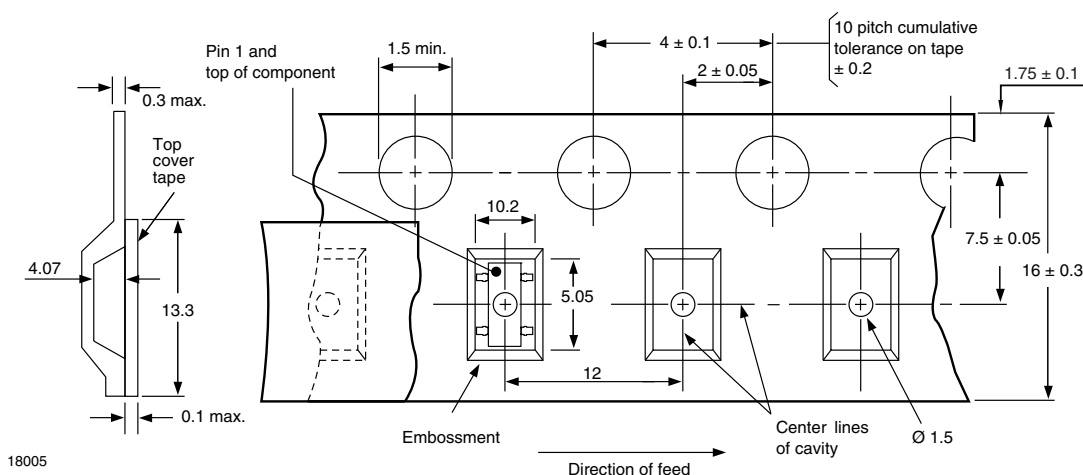

18005

SMD-4, 90° Rotation (“T1”)

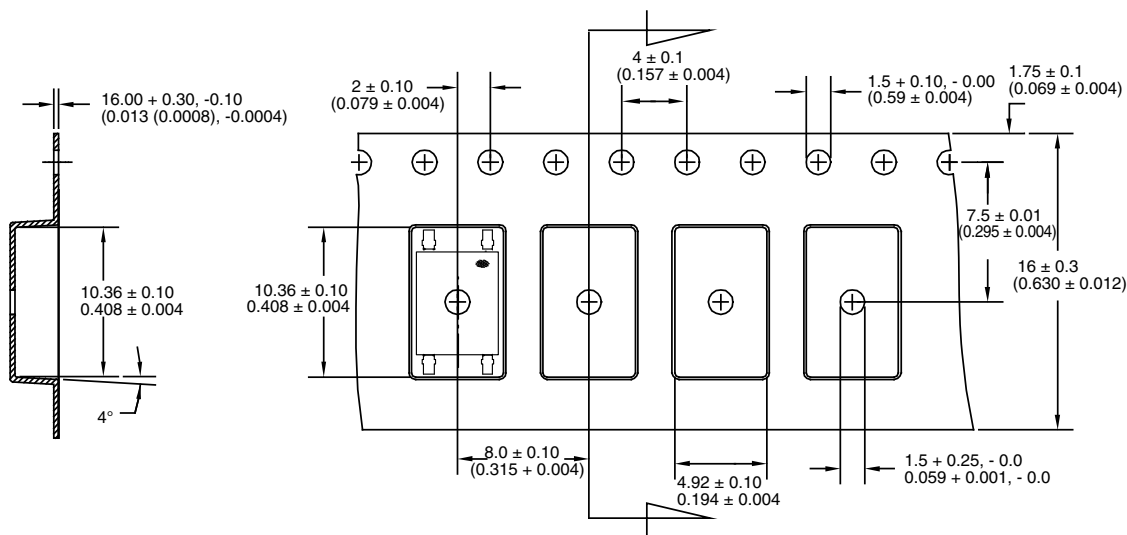

18401

SOLDER PROFILES

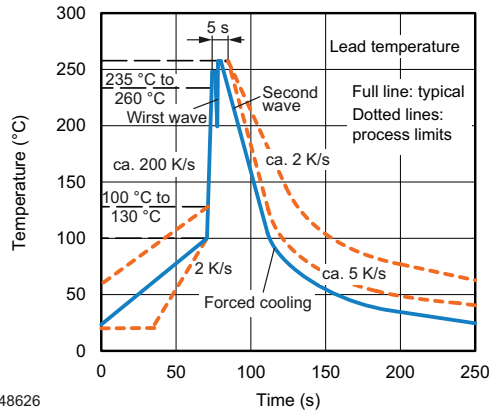

948626

Fig. 17 - Recommended Wave Soldering Double Wave Profile for DIP Devices

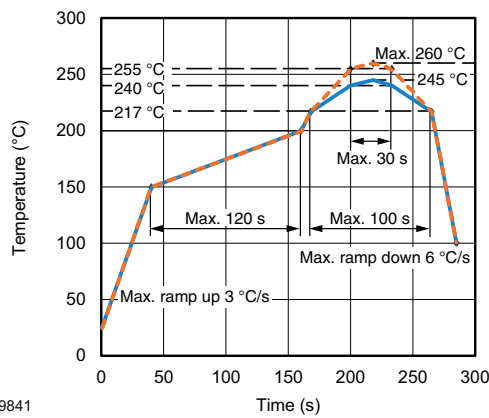

19841

Fig. 18 - Recommended Lead (Pb)-free Reflow Solder Profile for SMD Devices

HANDLING AND STORAGE CONDITIONS

ESD level: HBM class 2

Floor life: unlimited

Conditions: $T_{amb} < 30\text{ °C}$, RH < 85 %

Moisture sensitivity level 1, according to J-STD-020



Disclaimer

ALL PRODUCT, PRODUCT SPECIFICATIONS AND DATA ARE SUBJECT TO CHANGE WITHOUT NOTICE TO IMPROVE RELIABILITY, FUNCTION OR DESIGN OR OTHERWISE.

Vishay Intertechnology, Inc., its affiliates, agents, and employees, and all persons acting on its or their behalf (collectively, "Vishay"), disclaim any and all liability for any errors, inaccuracies or incompleteness contained in any datasheet or in any other disclosure relating to any product.

Vishay makes no warranty, representation or guarantee regarding the suitability of the products for any particular purpose or the continuing production of any product. To the maximum extent permitted by applicable law, Vishay disclaims (i) any and all liability arising out of the application or use of any product, (ii) any and all liability, including without limitation special, consequential or incidental damages, and (iii) any and all implied warranties, including warranties of fitness for particular purpose, non-infringement and merchantability.

Statements regarding the suitability of products for certain types of applications are based on Vishay's knowledge of typical requirements that are often placed on Vishay products in generic applications. Such statements are not binding statements about the suitability of products for a particular application. It is the customer's responsibility to validate that a particular product with the properties described in the product specification is suitable for use in a particular application. Parameters provided in datasheets and / or specifications may vary in different applications and performance may vary over time. All operating parameters, including typical parameters, must be validated for each customer application by the customer's technical experts. Product specifications do not expand or otherwise modify Vishay's terms and conditions of purchase, including but not limited to the warranty expressed therein.

Except as expressly indicated in writing, Vishay products are not designed for use in medical, life-saving, or life-sustaining applications or for any other application in which the failure of the Vishay product could result in personal injury or death. Customers using or selling Vishay products not expressly indicated for use in such applications do so at their own risk. Please contact authorized Vishay personnel to obtain written terms and conditions regarding products designed for such applications.

No license, express or implied, by estoppel or otherwise, to any intellectual property rights is granted by this document or by any conduct of Vishay. Product names and markings noted herein may be trademarks of their respective owners.