

### FEATURES

8 channels of LNA, VGA, AAF, ADC, and I/Q demodulator

Low noise preamplifier (LNA)

Input-referred noise: 0.75 nV/ $\sqrt{\text{Hz}}$  typical at 5 MHz  
(gain = 21.3 dB)

SPI-programmable gain: 15.6 dB/17.9 dB/21.3 dB

Single-ended input:  $V_{\text{IN}}$  maximum = 733 mV p-p/  
550 mV p-p/367 mV p-p

Dual-mode active input impedance matching

Bandwidth (BW) > 100 MHz

Full-scale (FS) output: 4.4 V p-p differential

Variable gain amplifier (VGA)

Attenuator range: -42 dB to 0 dB

Postamp gain: 21 dB/24 dB/27 dB/30 dB

Linear-in-dB gain control

Antialiasing filter (AAF)

Programmable second-order LPF from 8 MHz to 18 MHz

Programmable HPF

Analog-to-digital converter (ADC)

12 bits at 10 MSPS to 80 MSPS

SNR: 70 dB

SFDR: 75 dB

Serial LVDS (ANSI-644, IEEE 1596.3 reduced range link)

Data and frame clock outputs

CW mode I/Q demodulator

Individual programmable phase rotation

Output dynamic range per channel >160 dBFS/ $\sqrt{\text{Hz}}$

Low power: 195 mW per channel at 12 bits/40 MSPS (TGC),  
94 mW per channel for CW Doppler

Flexible power-down modes

Overload recovery in <10 ns

Fast recovery from low power standby mode: <2  $\mu\text{s}$

100-lead TQFP\_EP

### APPLICATIONS

Medical imaging/ultrasound

Automotive radar

### PRODUCT HIGHLIGHTS

1. Small Footprint.  
Eight channels are contained in a small, space-saving package. Full TGC path, ADC, and I/Q demodulator contained within a 100-lead, 16 mm  $\times$  16 mm TQFP.
2. Low Power.  
In TGC mode, low power of 195 mW per channel at 40 MSPS. In CW mode, ultralow power of 94 mW per channel.
3. Integrated High Dynamic Range I/Q Demodulator with Phase Rotation.
4. Ease of Use.  
A data clock output (DCO $\pm$ ) operates up to 480 MHz and supports double data rate (DDR) operation.
5. User Flexibility.  
Serial port interface (SPI) control offers a wide range of flexible features to meet specific system requirements.
6. Integrated Second-Order Antialiasing Filter.  
This filter is placed before the ADC and is programmable from 8 MHz to 18 MHz.

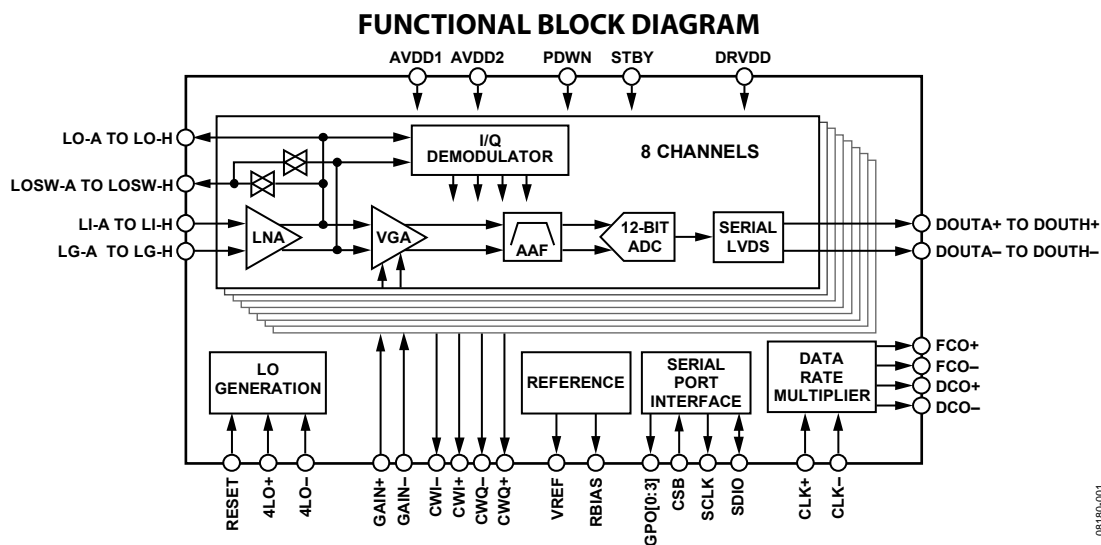

Figure 1.

### Rev. 0

Information furnished by Analog Devices is believed to be accurate and reliable. However, no responsibility is assumed by Analog Devices for its use, nor for any infringements of patents or other rights of third parties that may result from its use. Specifications subject to change without notice. No license is granted by implication or otherwise under any patent or patent rights of Analog Devices. Trademarks and registered trademarks are the property of their respective owners.

**TABLE OF CONTENTS**

|  |    |  |    |
|--|----|--|----|
| Features .....                                   | 1  | Ultrasound .....                                       | 21 |
| Applications.....                                | 1  | Channel Overview .....                                 | 22 |
| Product Highlights .....                         | 1  | Input Overdrive .....                                  | 25 |
| Functional Block Diagram .....                   | 1  | CW Doppler Operation.....                              | 25 |
| Revision History .....                           | 2  | TGC Operation.....                                     | 29 |
| General Description .....                        | 3  | ADC .....  | 33 |
| Specifications.....                              | 4  | Clock Input Considerations.....                        | 33 |
| AC Specifications.....                           | 4  | Digital Outputs and Timing .....                       | 35 |
| Digital Specifications .....                     | 7  | Serial Port Interface (SPI).....                       | 39 |
| Switching Specifications .....                   | 8  | Hardware Interface.....                                | 40 |
| ADC Timing Diagrams .....                        | 9  | Memory Map .....                                       | 41 |
| Absolute Maximum Ratings.....                    | 10 | Reading the Memory Map Table.....                      | 41 |
| Thermal Impedance .....                          | 10 | Reserved Locations .....                               | 41 |
| ESD Caution.....                                 | 10 | Default Values .....                                   | 41 |
| Pin Configuration and Function Descriptions..... | 11 | Logic Levels.....                                      | 41 |
| Typical Performance Characteristics .....        | 14 | Applications Information .....                         | 45 |
| TGC Mode.....                                    | 14 | Power and Ground Recommendations .....                 | 45 |
| CW Doppler Mode.....                             | 17 | Exposed Paddle Thermal Heat Slug Recommendations ..... | 45 |
| Equivalent Circuits .....                        | 19 | Outline Dimensions .....                               | 46 |
| Theory of Operation .....                        | 21 | Ordering Guide .....                                   | 46 |

**REVISION HISTORY****7/09—Revision 0: Initial Version**

## GENERAL DESCRIPTION

The AD9276 is designed for low cost, low power, small size, and ease of use. It contains eight channels of a variable gain amplifier (VGA) with a low noise preamplifier (LNA); an anti-aliasing filter (AAF); a 12-bit, 10 MSPS to 80 MSPS analog-to-digital converter (ADC); and an I/Q demodulator with programmable phase rotation.

Each channel features a variable gain range of 42 dB, a fully differential signal path, an active input preamplifier termination, a maximum gain of up to 52 dB, and an ADC with a conversion rate of up to 80 MSPS. The channel is optimized for dynamic performance and low power in applications where a small package size is critical.

The LNA has a single-ended-to-differential gain that is selectable through the SPI. The LNA input noise is typically  $0.75 \text{ nV}/\sqrt{\text{Hz}}$  at a gain of 21.3 dB, and the combined input-referred noise of the entire channel is  $0.85 \text{ nV}/\sqrt{\text{Hz}}$  at maximum gain. Assuming a 15 MHz noise bandwidth (NBW) and a 21.3 dB LNA gain, the input SNR is roughly 92 dB. In CW Doppler mode, each LNA output drives an I/Q demodulator. Each demodulator has independently programmable phase rotation through the SPI with 16 phase settings.

The AD9276 requires a LVPECL-/CMOS-/LVDS-compatible sample rate clock for full performance operation. No external reference or driver components are required for many applications.

The ADC automatically multiplies the sample rate clock for the appropriate LVDS serial data rate. A data clock ( $\text{DCO}\pm$ ) for capturing data on the output and a frame clock ( $\text{FCO}\pm$ ) trigger for signaling a new output byte are provided.

Powering down individual channels is supported to increase battery life for portable applications. A standby mode option allows quick power-up for power cycling. In CW Doppler operation, the VGA, AAF, and ADC are powered down. The power of the TGC path scales with selectable ADC speed power modes.

The ADC contains several features designed to maximize flexibility and minimize system cost, such as a programmable clock, data alignment, and programmable digital test pattern generation. The digital test patterns include built-in fixed patterns, built-in pseudo-random patterns, and custom user-defined test patterns entered via the serial port interface.

Fabricated in an advanced CMOS process, the AD9276 is available in a  $16 \text{ mm} \times 16 \text{ mm}$ , RoHS compliant, 100-lead TQFP. It is specified over the industrial temperature range of  $-40^\circ\text{C}$  to  $+85^\circ\text{C}$ .

## SPECIFICATIONS

## AC SPECIFICATIONS

AVDD1 = 1.8 V, AVDD2 = 3.0 V, DRVDD = 1.8 V, 1.0 V internal ADC reference,  $f_{IN} = 5$  MHz,  $R_S = 50 \Omega$ , LNA gain = 21.3 dB, LNA bias = high, PGA gain = 27 dB, GAIN- = 0.8 V, AAF LPF cutoff =  $f_{SAMPLE}/3$  (Mode I/Mode II),  $f_{SAMPLE}/4.5$  (Mode III), HPF cutoff = LPF cutoff/20.7 (default), Mode I =  $f_{SAMPLE} = 40$  MSPS, Mode II =  $f_{SAMPLE} = 65$  MSPS, Mode III =  $f_{SAMPLE} = 80$  MSPS, full temperature, ANSI-644 LVDS mode, unless otherwise noted.

Table 1.

| Parameter <sup>1</sup>                    | Test Conditions/Comments                            | Min | Typ            | Max | Unit                   |
|---|---|-----|----------------|-----|------------------------|
| <b>LNA CHARACTERISTICS</b>                |   |     |                |     |                        |
| Gain                                      | Single-ended input to differential output           |     | 15.6/17.9/21.3 |     | dB                     |
|   | Single-ended input to single-ended output           |     | 9.6/11.9/15.3  |     | dB                     |
| Input Voltage Range<br>(Single-Ended)     | LNA output limited to 4.4 V p-p differential output |     |                |     |                        |
|   | LNA gain = 15.6 dB                                  |     | 733            |     | mV p-p                 |
|   | LNA gain = 17.9 dB                                  |     | 550            |     | mV p-p                 |
|   | LNA gain = 21.3 dB                                  |     | 367            |     | mV p-p                 |
| Input Common Mode (LI-x, LG-x)            |   |     | 1.0            |     | V                      |
| Output Common Mode (LO-x)                 |   |     | 1.5            |     | V                      |
| Output Common Mode (LOSW-x)               | Switch off  |     | High-Z         |     | $\Omega$               |
|   | Switch on   |     | 1.5            |     | V                      |
| Input Resistance (LI-x)                   | $R_{FB} = 250 \Omega$                               |     | 50             |     | $\Omega$               |
|   | $R_{FB} = 500 \Omega$                               |     | 100            |     | $\Omega$               |
|   | $R_{FB} = \infty$                                   |     | 15             |     | k $\Omega$             |
|   |   |     | 22             |     | pF                     |
| -3 dB Bandwidth                           |   |     | 100            |     | MHz                    |
| Input Noise Voltage                       | $R_S = 0 \Omega$ , $R_{FB} = \infty$                |     |                |     |                        |
|   | LNA gain = 15.6 dB                                  |     | 0.98           |     | nV/ $\sqrt{\text{Hz}}$ |
|   | LNA gain = 17.9 dB                                  |     | 0.86           |     | nV/ $\sqrt{\text{Hz}}$ |
|   | LNA gain = 21.3 dB                                  |     | 0.75           |     | nV/ $\sqrt{\text{Hz}}$ |
| Input Noise Current                       | $R_{FB} = \infty$                                   |     | 1              |     | pA/ $\sqrt{\text{Hz}}$ |
| 1 dB Input Compression Point              | GAIN+ = 0 V   |     |                |     |                        |
|   | LNA gain = 15.6 dB                                  |     | 1.0            |     | V p-p                  |
|   | LNA gain = 17.9 dB                                  |     | 0.8            |     | V p-p                  |
|   | LNA gain = 21.3 dB                                  |     | 0.5            |     | V p-p                  |
| Noise Figure                              | $R_S = 50 \Omega$                                   |     |                |     |                        |
|   | LNA gain = 15.6 dB, $R_{FB} = 200 \Omega$           |     | 4.8            |     | dB                     |
|   | LNA gain = 17.9 dB, $R_{FB} = 250 \Omega$           |     | 4.1            |     | dB                     |
|   | LNA gain = 21.3 dB, $R_{FB} = 350 \Omega$           |     | 3.2            |     | dB                     |
|   | LNA gain = 15.6 dB, $R_{FB} = \infty$               |     | 3.4            |     | dB                     |
|   | LNA gain = 17.9 dB, $R_{FB} = \infty$               |     | 2.8            |     | dB                     |
|   | LNA gain = 21.3 dB, $R_{FB} = \infty$               |     | 2.3            |     | dB                     |
| <b>FULL-CHANNEL (TGC) CHARACTERISTICS</b> |   |     |                |     |                        |
| AAF Low-Pass Cutoff                       |   |     |                |     |                        |
| In Range                                  | -3 dB, programmable                                 | 8   |                | 18  | MHz                    |
| In Range AAF Bandwidth Tolerance          |   |     | $\pm 10$       |     | %                      |
| Group Delay Variation                     | $f = 1$ MHz to 18 MHz, GAIN+ = 0 V to 1.6 V         |     | $\pm 0.5$      |     | ns                     |
| Input-Referred Noise Voltage              | GAIN+ = 1.6 V, $R_{FB} = \infty$                    |     |                |     |                        |
|   | LNA gain = 15.6 dB                                  |     | 1.26           |     | nV/ $\sqrt{\text{Hz}}$ |
|   | LNA gain = 17.9 dB                                  |     | 1.04           |     | nV/ $\sqrt{\text{Hz}}$ |
|   | LNA gain = 21.3 dB                                  |     | 0.85           |     | nV/ $\sqrt{\text{Hz}}$ |

| Parameter <sup>1</sup>                                 | Test Conditions/Comments   | Min                | Typ         | Max                | Unit    |
|--|--|--------------------|-------------|--------------------|---------|
| Noise Figure   | GAIN+ = 1.6 V, R <sub>S</sub> = 50 Ω   |                    |             |                    |         |
| Active Termination Matched<br>Mode I/Mode II/Mode III  | LNA gain = 15.6 dB, R <sub>FB</sub> = 200 Ω  |                    | 8.0/7.7/7.6 |                    | dB      |
|  | LNA gain = 17.9 dB, R <sub>FB</sub> = 250 Ω  |                    | 6.6/6.2/6.1 |                    | dB      |
|  | LNA gain = 21.3 dB, R <sub>FB</sub> = 350 Ω  |                    | 4.7/4.5/4.4 |                    | dB      |
| Unterminated   | LNA gain = 15.6 dB, R <sub>FB</sub> = ∞  |                    | 4.7         |                    | dB      |
|  | LNA gain = 17.9 dB, R <sub>FB</sub> = ∞  |                    | 3.7         |                    | dB      |
|  | LNA gain = 21.3 dB, R <sub>FB</sub> = ∞  |                    | 2.8         |                    | dB      |
| Correlated Noise Ratio                                 | No signal, correlated/uncorrelated   |                    | –30         |                    | dB      |
| Output Offset  |  | –35                |             | +35                | LSB     |
| Signal-to-Noise Ratio (SNR)<br>Mode I/Mode II/Mode III | f <sub>IN</sub> = 5 MHz at –10 dBFS, GAIN+ = 0 V   |                    | 65/64/63    |                    | dBFS    |
|  | f <sub>IN</sub> = 5 MHz at –1 dBFS, GAIN+ = 1.6 V  |                    | 57/56/54.5  |                    | dBFS    |
| Harmonic Distortion<br>Mode I/Mode II/Mode III         |  |                    |             |                    |         |
| Second Harmonic  | f <sub>IN</sub> = 5 MHz at –10 dBFS, GAIN+ = 0 V   |                    | –62/–58/–55 |                    | dBc     |
|  | f <sub>IN</sub> = 5 MHz at –1 dBFS, GAIN+ = 1.6 V  |                    | –60/–61/–58 |                    | dBc     |
| Third Harmonic   | f <sub>IN</sub> = 5 MHz at –10 dBFS, GAIN+ = 0 V   |                    | –71/–60/–60 |                    | dBc     |
|  | f <sub>IN</sub> = 5 MHz at –1 dBFS, GAIN+ = 1.6 V  |                    | –57/–55/–56 |                    | dBc     |
| Two-Tone Intermodulation (IMD3)                        | f <sub>RF1</sub> = 5.015 MHz, f <sub>RF2</sub> = 5.020 MHz,<br>A <sub>RF1</sub> = 0 dB, A <sub>RF2</sub> = –20 dB, GAIN+ = 1.6 V,<br>IMD3 relative to A <sub>RF2</sub> |                    | –55         |                    | dBc     |
| Channel-to-Channel Crosstalk                           | f <sub>IN</sub> = 5 MHz at –1 dBFS   |                    | –70         |                    | dB      |
|  | Overrange condition <sup>2</sup>   |                    | –65         |                    | dB      |
| Channel-to-Channel Delay<br>Variation                  | Full TGC path, f <sub>IN</sub> = 5 MHz, GAIN+ = 0 V to 1.6 V   |                    | 0.3         |                    | Degrees |
| PGA Gain   | Differential input to differential output  |                    | 21/24/27/30 |                    | dB      |
| GAIN ACCURACY  | 25°C   |                    |             |                    |         |
| Gain Law Conformance Error<br>Mode I/Mode II/Mode III  | 0 < GAIN+ < 0.16 V   |                    | 1.5         |                    | dB      |
|  | 0.16 V < GAIN+ < 1.44 V  | –1.5/–1.5/<br>–1.6 |             | +1.5/+1.5/<br>+1.6 | dB      |
|  | 1.44 V < GAIN+ < 1.6 V   | –1.5/–1.5/<br>–1.6 | –2.5        | +1.5/+1.5/<br>+1.6 | dB      |
| Linear Gain Error                                      | GAIN+ = 0.8 V, normalized for ideal AAF loss   | –1.5               |             | +1.5               | dB      |
| Channel-to-Channel Matching                            | 0.16 V < GAIN+ < 1.44 V  |                    | 0.1         |                    | dB      |
| GAIN CONTROL INTERFACE                                 |  |                    |             |                    |         |
| Normal Operating Range                                 |  | 0                  |             | 1.6                | V       |
| Gain Range   | GAIN+ = 0 V to 1.6 V   | –42                |             | 0                  | dB      |
| Scale Factor   |  |                    | 28.5        |                    | dB/V    |
| Response Time  | 42 dB change   |                    | 750         |                    | ns      |
| GAIN+ Impedance  | Single-ended   |                    | 10          |                    | MΩ      |
| GAIN– Impedance  | Single-ended   |                    | 70          |                    | kΩ      |
| CW DOPPLER MODE  |  |                    |             |                    |         |
| LO Frequency   | f <sub>LO</sub> = f <sub>4LO</sub> /4  | 1                  |             | 10                 | MHz     |
| Phase Increment  | Per channel  |                    | 22.5        |                    | Degrees |
| Output DC Bias (Single-Ended)                          | CWI+, CWI–, CWQ+, CWQ–   |                    | 1.5         |                    | V       |
| Maximum Output Swing                                   | Per CWI+, CWI–, CWQ+, CWQ–, per channel<br>enabled   |                    |             | ±1.25              | mA      |
| Transconductance (Differential)                        | Demodulated I <sub>OUT</sub> /V <sub>IN</sub> , each I or Q output   |                    |             |                    |         |
|  | LNA gain = 15.6 dB   |                    | 1.8         |                    | mA/V    |
|  | LNA gain = 17.9 dB   |                    | 2.4         |                    | mA/V    |
|  | LNA gain = 21.3 dB   |                    | 3.5         |                    | mA/V    |

# AD9276

| Parameter <sup>1</sup>                             | Test Conditions/Comments   | Min | Typ            | Max            | Unit                     |
|--|--|-----|----------------|----------------|--------------------------|
| Input-Referred Noise Voltage                       | $R_S = 0 \Omega$ , $R_{FB} = \infty$   |     |                |                |                          |
|  | LNA gain = 15.6 dB   |     | 1.5            |                | nV/ $\sqrt{\text{Hz}}$   |
|  | LNA gain = 17.9 dB   |     | 1.4            |                | nV/ $\sqrt{\text{Hz}}$   |
| Noise Figure                                       | LNA gain = 21.3 dB   |     | 1.3            |                | nV/ $\sqrt{\text{Hz}}$   |
|  | $R_S = 50 \Omega$ , $R_{FB} = \infty$  |     |                |                |                          |
|  | LNA gain = 15.6 dB   |     | 5.7            |                | dB                       |
| Input-Referred Dynamic Range                       | LNA gain = 17.9 dB   |     | 5.3            |                | dB                       |
|  | LNA gain = 21.3 dB   |     | 4.8            |                | dB                       |
|  | $R_S = 0 \Omega$ , $R_{FB} = \infty$   |     |                |                |                          |
| Output-Referred SNR                                | LNA gain = 15.6 dB   |     | 164            |                | dBFS/ $\sqrt{\text{Hz}}$ |
|  | LNA gain = 17.9 dB   |     | 162            |                | dBFS/ $\sqrt{\text{Hz}}$ |
|  | LNA gain = 21.3 dB   |     | 160            |                | dBFS/ $\sqrt{\text{Hz}}$ |
| Two-Tone Intermodulation (IMD3)                    | $-3$ dBFS input, $f_{RF} = 2.5$ MHz, $f_{4LO} = 10$ MHz, 1 kHz offset  |     | 155            |                | dBc/ $\sqrt{\text{Hz}}$  |
| Two-Tone Intermodulation (IMD3)                    | $f_{RF1} = 5.015$ MHz, $f_{RF2} = 5.020$ MHz, $f_{4LO} = 20$ MHz, $A_{RF1} = 0$ dB, $A_{RF2} = -20$ dB, IMD3 relative to $A_{RF2}$ |     | -58            |                | dB                       |
| Quadrature Phase Error                             | I to Q, all phases, 1 $\sigma$   |     | 0.15           |                | Degrees                  |
| I/Q Amplitude Imbalance                            | I to Q, all phases, 1 $\sigma$   |     | 0.015          |                | dB                       |
| Channel-to-Channel Matching                        | Phase I to I, Q to Q, 1 $\sigma$   |     | 0.5            |                | Degrees                  |
|  | Amplitude I to I, Q to Q, 1 $\sigma$   |     | 0.25           |                | dB                       |
| <b>POWER SUPPLY</b>                                |  |     |                |                |                          |
| Mode I/Mode II/Mode III                            |  |     |                |                |                          |
| AVDD1  |  | 1.7 | 1.8            | 1.9            | V                        |
| AVDD2  |  | 2.7 | 3.0            | 3.6            | V                        |
| DRVDD  |  | 1.7 | 1.8            | 1.9            | V                        |
| $I_{AVDD1}$  | TGC mode   |     | 190/263/317    |                | mA                       |
| $I_{AVDD2}$  | CW Doppler mode  |     | 15             |                | mA                       |
|  | TGC mode, no signal  |     | 365            |                | mA                       |
| $I_{DRVDD}$  | CW Doppler mode per channel enabled, no signal   |     | 30             |                | mA                       |
|  |  |     | 49/51/52       |                | mA                       |
| Total Power Dissipation (Including Output Drivers) | TGC mode, no signal  |     | 1560/1690/1780 | 1800/1940/2050 | mW                       |
|  | CW Doppler mode with eight channels enabled, no signal   |     | 750            |                | mW                       |
| Power-Down Dissipation                             |  |     |                | 5              | mW                       |
| Standby Power Dissipation                          |  |     |                | 175/200/210    | mW                       |
| Power Supply Rejection Ratio (PSRR)                |  |     | 1.6            |                | mV/V                     |
| ADC RESOLUTION                                     |  |     | 12             |                | Bits                     |
| <b>ADC REFERENCE</b>                               |  |     |                |                |                          |
| Output Voltage Error                               | $V_{REF} = 1$ V  |     |                | $\pm 20$       | mV                       |
| Load Regulation at 1.0 mA                          | $V_{REF} = 1$ V  |     | 2              |                | mV                       |
| Input Resistance                                   |  |     | 6              |                | k $\Omega$               |

<sup>1</sup> See the AN-835 Application Note, *Understanding High Speed ADC Testing and Evaluation*, for a complete set of definitions and information about how these tests were completed.

<sup>2</sup> The overrange condition is specified as being 6 dB more than the full-scale input range.

**DIGITAL SPECIFICATIONS**

AVDD1 = 1.8 V, AVDD2 = 3.0 V, DRVDD = 1.8 V, 1.0 V internal ADC reference,  $f_{IN} = 5$  MHz, full temperature, unless otherwise noted.

**Table 2.**

| Parameter <sup>1</sup>   | Temperature | Min   | Typ              | Max         | Unit   |
|--|-------------|-------|------------------|-------------|--------|
| CLOCK INPUTS (CLK+, CLK-)  |             |       |                  |             |        |
| Logic Compliance   |             |       | CMOS/LVDS/LVPECL |             |        |
| Differential Input Voltage <sup>2</sup>  | Full        | 250   |                  |             | mV p-p |
| Input Common-Mode Voltage  | Full        |       | 1.2              |             | V      |
| Input Resistance (Differential)  | 25°C        |       | 20               |             | kΩ     |
| Input Capacitance  | 25°C        |       | 1.5              |             | pF     |
| CW 4LO INPUTS (4LO+, 4LO-)   |             |       |                  |             |        |
| Logic Compliance   |             |       | CMOS/LVDS/LVPECL |             |        |
| Differential Input Voltage <sup>2</sup>  | Full        | 250   |                  |             | mV p-p |
| Input Common-Mode Voltage  | Full        |       | 1.2              |             | V      |
| Input Resistance (Differential)  | 25°C        |       | 20               |             | kΩ     |
| Input Capacitance  | 25°C        |       | 1.5              |             | pF     |
| LOGIC INPUTS (PDWN, STBY, SCLK, RESET)   |             |       |                  |             |        |
| Logic 1 Voltage  | Full        | 1.2   |                  | 3.6         | V      |
| Logic 0 Voltage  | Full        |       |                  | 0.3         | V      |
| Input Resistance   | 25°C        |       | 30               |             | kΩ     |
| Input Capacitance  | 25°C        |       | 0.5              |             | pF     |
| LOGIC INPUT (CSB)  |             |       |                  |             |        |
| Logic 1 Voltage  | Full        | 1.2   |                  | 3.6         | V      |
| Logic 0 Voltage  | Full        |       |                  | 0.3         | V      |
| Input Resistance   | 25°C        |       | 70               |             | kΩ     |
| Input Capacitance  | 25°C        |       | 0.5              |             | pF     |
| LOGIC INPUT (SDIO)   |             |       |                  |             |        |
| Logic 1 Voltage  | Full        | 1.2   |                  | DRVDD + 0.3 | V      |
| Logic 0 Voltage  | Full        | 0     |                  | 0.3         | V      |
| Input Resistance   | 25°C        |       | 30               |             | kΩ     |
| Input Capacitance  | 25°C        |       | 2                |             | pF     |
| LOGIC OUTPUT (SDIO) <sup>3</sup>   |             |       |                  |             |        |
| Logic 1 Voltage ( $I_{OH} = 800 \mu A$ )   | Full        |       | 1.79             |             | V      |
| Logic 0 Voltage ( $I_{OL} = 50 \mu A$ )  | Full        |       |                  | 0.05        | V      |
| DIGITAL OUTPUTS (DOUTx+, DOUTx-), (ANSI-644) <sup>1</sup>                            |             |       |                  |             |        |
| Logic Compliance   |             |       | LVDS             |             |        |
| Differential Output Voltage ( $V_{OD}$ )   | Full        | 247   |                  | 454         | mV     |
| Output Offset Voltage ( $V_{OS}$ )   | Full        | 1.125 |                  | 1.375       | V      |
| Output Coding (Default)  |             |       | Offset binary    |             |        |
| DIGITAL OUTPUTS (DOUTx+, DOUTx-),<br>(LOW POWER, REDUCED SIGNAL OPTION) <sup>1</sup> |             |       |                  |             |        |
| Logic Compliance   |             |       | LVDS             |             |        |
| Differential Output Voltage ( $V_{OD}$ )   | Full        | 150   |                  | 250         | mV     |
| Output Offset Voltage ( $V_{OS}$ )   | Full        | 1.10  |                  | 1.30        | V      |
| Output Coding (Default)  |             |       | Offset binary    |             |        |
| LOGIC OUTPUTS (GPO0, GPO1, GPO2, GPO3)   |             |       |                  |             |        |
| Logic 0 Voltage ( $I_{OL} = 50 \mu A$ )  | Full        |       |                  | 0.05        | V      |

<sup>1</sup> See the AN-835 Application Note, *Understanding High Speed ADC Testing and Evaluation*, for a complete set of definitions and information about how these tests were completed.

<sup>2</sup> Specified for LVDS and LVPECL only.

<sup>3</sup> Specified for 13 SDIO pins sharing the same connection.

# AD9276

## SWITCHING SPECIFICATIONS

AVDD1 = 1.8 V, AVDD2 = 3.0 V, DRVDD = 1.8 V, 1.0 V internal ADC reference,  $f_{IN} = 5$  MHz, full temperature, unless otherwise noted.

Table 3.

| Parameter <sup>1</sup>                              | Temperature | Min                     | Typ                         | Max                     | Unit         |
|---|-------------|-------------------------|-----------------------------|-------------------------|--------------|
| <b>CLOCK<sup>2</sup></b>                            |             |                         |                             |                         |              |
| Clock Rate  |             |                         |                             |                         |              |
| 40 MSPS (Mode I)                                    | Full        | 10                      |                             | 40                      | MHz          |
| 65 MSPS (Mode II)                                   | Full        | 10                      |                             | 65                      | MHz          |
| 80 MSPS (Mode III)                                  | Full        | 10                      |                             | 80                      | MHz          |
| Clock Pulse Width High ( $t_{EH}$ )                 | Full        |                         | 6.25                        |                         | ns           |
| Clock Pulse Width Low ( $t_{EL}$ )                  | Full        |                         | 6.25                        |                         | ns           |
| <b>OUTPUT PARAMETERS<sup>2, 3</sup></b>             |             |                         |                             |                         |              |
| Propagation Delay ( $t_{PD}$ )                      | Full        | $(t_{SAMPLE}/2) + 1.5$  | $(t_{SAMPLE}/2) + 2.3$      | $(t_{SAMPLE}/2) + 3.1$  | ns           |
| Rise Time ( $t_r$ ) (20% to 80%)                    | Full        |                         | 300                         |                         | ps           |
| Fall Time ( $t_f$ ) (20% to 80%)                    | Full        |                         | 300                         |                         | ps           |
| FCO Propagation Delay ( $t_{FCO}$ )                 | Full        | $(t_{SAMPLE}/2) + 1.5$  | $(t_{SAMPLE}/2) + 2.3$      | $(t_{SAMPLE}/2) + 3.1$  | ns           |
| DCO Propagation Delay ( $t_{CPD}$ ) <sup>4</sup>    | Full        |                         | $t_{FCO} + (t_{SAMPLE}/24)$ |                         | ns           |
| DCO to Data Delay ( $t_{DATA}$ ) <sup>4</sup>       | Full        | $(t_{SAMPLE}/24) - 300$ | $(t_{SAMPLE}/24)$           | $(t_{SAMPLE}/24) + 300$ | ps           |
| DCO to FCO Delay ( $t_{FRAME}$ ) <sup>4</sup>       | Full        | $(t_{SAMPLE}/24) - 300$ | $(t_{SAMPLE}/24)$           | $(t_{SAMPLE}/24) + 300$ | ps           |
| Data-to-Data Skew ( $t_{DATA-MAX} - t_{DATA-MIN}$ ) | Full        |                         | $\pm 100$                   | $\pm 350$               | ps           |
| Wake-Up Time (Standby), GAIN+ = 0.5 V               | 25°C        |                         | 2                           |                         | $\mu$ s      |
| Wake-Up Time (Power-Down)                           | 25°C        |                         | 1                           |                         | ms           |
| Pipeline Latency                                    | Full        |                         | 8                           |                         | Clock cycles |
| <b>APERTURE</b>                                     |             |                         |                             |                         |              |
| Aperture Uncertainty (Jitter)                       | 25°C        |                         | <1                          |                         | ps rms       |
| <b>LO GENERATION</b>                                |             |                         |                             |                         |              |
| 4LO Frequency                                       | Full        | 4                       |                             | 40                      | MHz          |
| LO Divider RESET Setup Time <sup>5</sup>            | Full        | 5                       |                             |                         | ns           |
| LO Divider RESET Hold Time <sup>5</sup>             | Full        | 5                       |                             |                         | ns           |
| LO Divider RESET High Pulse Width                   | Full        | 20                      |                             |                         | ns           |

<sup>1</sup> See the AN-835 Application Note, *Understanding High Speed ADC Testing and Evaluation*, for a complete set of definitions and information about how these tests were completed.

<sup>2</sup> Can be adjusted via the SPI.

<sup>3</sup> Measurements were made using a part soldered to FR-4 material.

<sup>4</sup>  $t_{SAMPLE}/24$  is based on the number of bits divided by 2 because the delays are based on half duty cycles.

<sup>5</sup> RESET edge to rising 4LO edge.



ADC TIMING DIAGRAMS

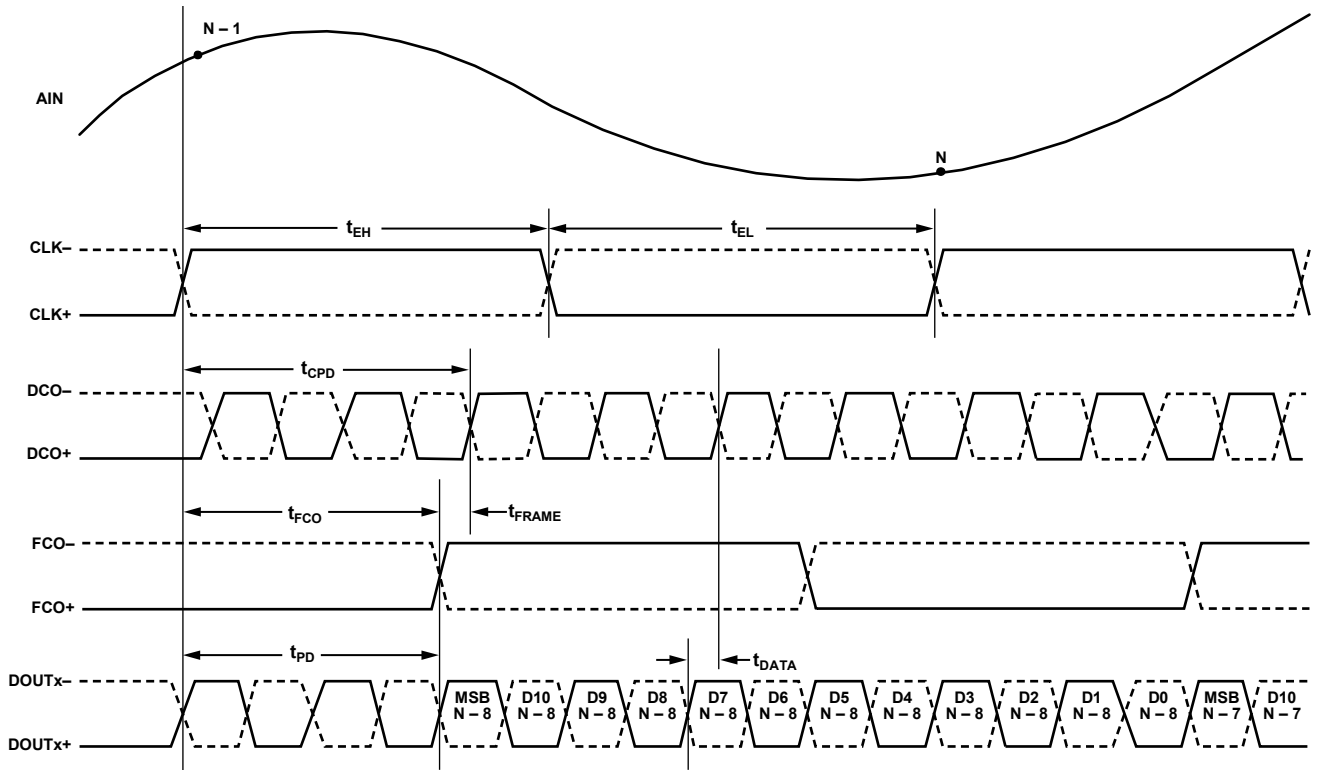

Figure 2. 12-Bit Data Serial Stream (Default)

08186-002

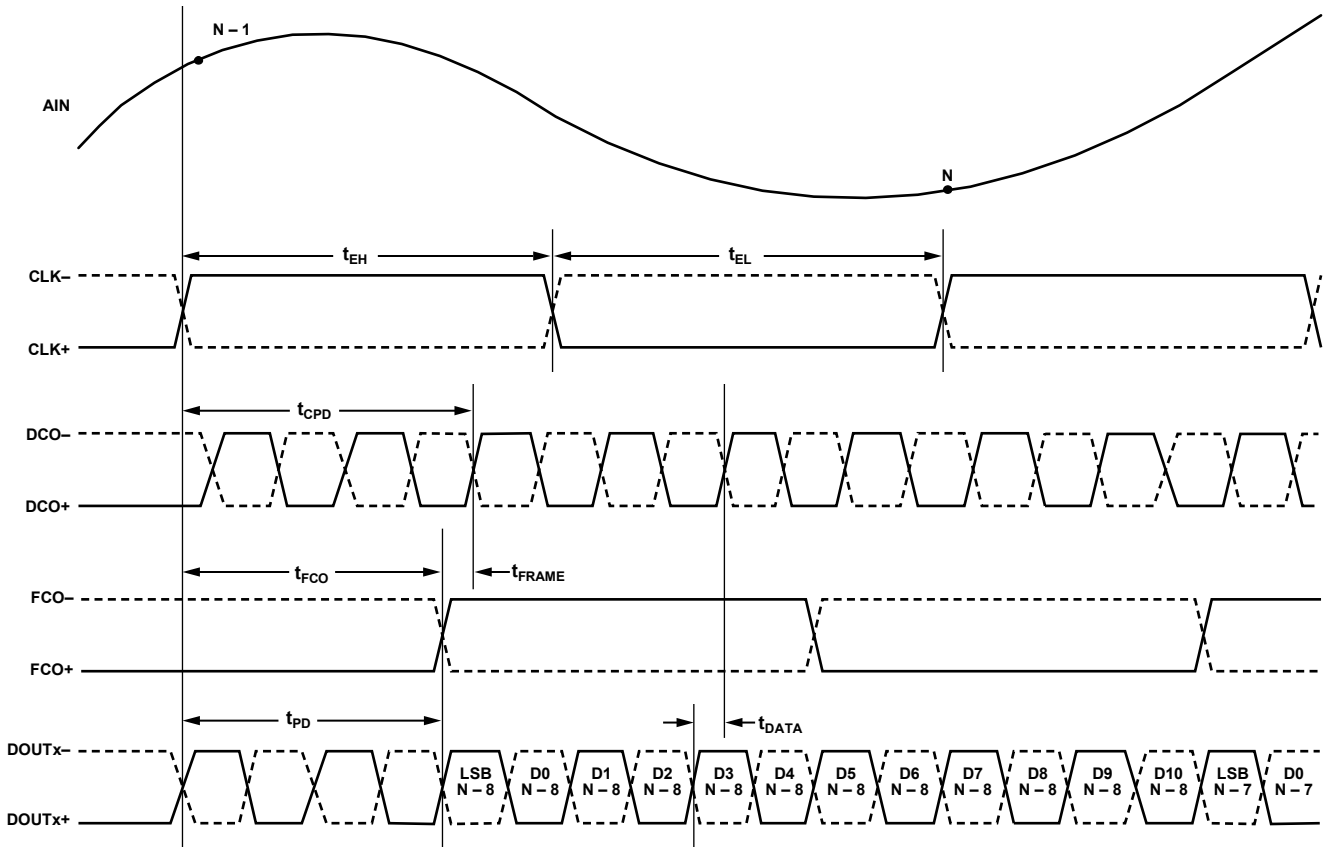

Figure 3. 12-Bit Data Serial Stream, LSB First

08186-003

## ABSOLUTE MAXIMUM RATINGS

Table 4.

| Parameter   | Rating           |
|---|------------------|
| AVDD1 to GND  | -0.3 V to +2.0 V |
| AVDD2 to GND  | -0.3 V to +3.9 V |
| DRVDD to GND  | -0.3 V to +2.0 V |
| GND to GND  | -0.3 V to +0.3 V |
| AVDD2 to AVDD1  | -2.0 V to +3.9 V |
| AVDD1 to DRVDD  | -2.0 V to +2.0 V |
| AVDD2 to DRVDD  | -2.0 V to +3.9 V |
| Digital Outputs (DOUTx+, DOUTx-, DCO+, DCO-, FCO+, FCO-) to GND | -0.3 V to +2.0 V |
| CLK+, CLK-, SDIO to GND   | -0.3 V to +2.0 V |
| LI-x, LO-x, LOSW-x to GND                                       | -0.3 V to +3.9 V |
| CWI-, CWI+, CWQ-, CWQ+ to GND                                   | -0.3 V to +3.9 V |
| PDWN, STBY, SCLK, CSB to GND                                    | -0.3 V to +2.0 V |
| GAIN+, GAIN-, RESET, 4LO+, 4LO-, GPO0, GPO1, GPO2, GPO3 to GND  | -0.3 V to +3.9 V |
| RBIAS, VREF to GND  | -0.3 V to +2.0 V |
| Operating Temperature Range (Ambient)                           | -40°C to +85°C   |
| Storage Temperature Range (Ambient)                             | -65°C to +150°C  |
| Maximum Junction Temperature                                    | 150°C            |
| Lead Temperature (Soldering, 10 sec)                            | 300°C            |

Stresses above those listed under Absolute Maximum Ratings may cause permanent damage to the device. This is a stress rating only; functional operation of the device at these or any other conditions above those indicated in the operational section of this specification is not implied. Exposure to absolute maximum rating conditions for extended periods may affect device reliability.

### THERMAL IMPEDANCE

Table 5.

| Airflow Velocity (m/s) | $\theta_{JA}^1$ | $\theta_{JB}$ | $\theta_{JC}$ | Unit |
|------------------------|-----------------|---------------|---------------|------|
| 0.0                    | 20.3            |               |               | °C/W |
| 1.0                    | 14.4            | 7.6           | 4.7           | °C/W |
| 2.5                    | 12.9            |               |               | °C/W |

<sup>1</sup>  $\theta_{JA}$  for a 4-layer PCB with solid ground plane (simulated). Exposed pad soldered to PCB.

### ESD CAUTION



**ESD (electrostatic discharge) sensitive device.** Charged devices and circuit boards can discharge without detection. Although this product features patented or proprietary protection circuitry, damage may occur on devices subjected to high energy ESD. Therefore, proper ESD precautions should be taken to avoid performance degradation or loss of functionality.

# PIN CONFIGURATION AND FUNCTION DESCRIPTIONS

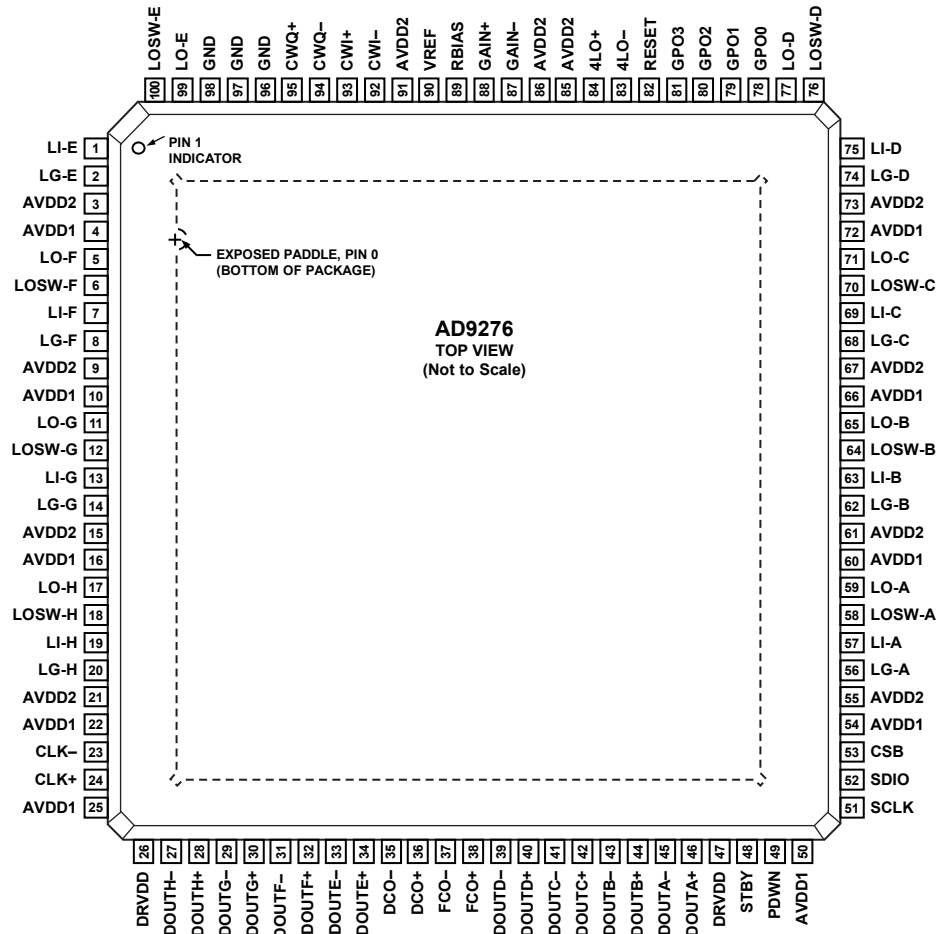

- NOTES**  
 1. THE EXPOSED PAD SHOULD BE TIED TO A QUIET ANALOG GROUND.

Figure 4. Pin Configuration

08180-004

Table 6. Pin Function Descriptions

| Pin No.                                  | Name   | Description   |
|--|--------|---|
| 0, 96, 97, 98                            | GND    | Ground. Exposed paddle should be tied to a quiet analog ground. |
| 1  | LI-E   | LNA Analog Input for Channel E.                                 |
| 2  | LG-E   | LNA Ground for Channel E.                                       |
| 3, 9, 15, 21, 55, 61, 67, 73, 85, 86, 91 | AVDD2  | 3.0 V Analog Supply.  |
| 4, 10, 16, 22, 25, 50, 54, 60, 66, 72    | AVDD1  | 1.8 V Analog Supply.  |
| 5  | LO-F   | LNA Analog Inverted Output for Channel F.                       |
| 6  | LOSW-F | LNA Analog Switched Output for Channel F.                       |
| 7  | LI-F   | LNA Analog Input for Channel F.                                 |
| 8  | LG-F   | LNA Ground for Channel F.                                       |
| 11                                       | LO-G   | LNA Analog Inverted Output for Channel G.                       |
| 12                                       | LOSW-G | LNA Analog Switched Output for Channel G.                       |
| 13                                       | LI-G   | LNA Analog Input for Channel G.                                 |
| 14                                       | LG-G   | LNA Ground for Channel G.                                       |
| 17                                       | LO-H   | LNA Analog Inverted Output for Channel H.                       |
| 18                                       | LOSW-H | LNA Analog Switched Output for Channel H.                       |
| 19                                       | LI-H   | LNA Analog Input for Channel H.                                 |
| 20                                       | LG-H   | LNA Ground for Channel H.                                       |

# AD9276

| Pin No. | Name   | Description                                      |
|---------|--------|--|
| 23      | CLK-   | Clock Input Complement.                          |
| 24      | CLK+   | Clock Input True.                                |
| 26, 47  | DRVDD  | 1.8 V Digital Output Driver Supply.              |
| 27      | DOUTH- | ADC H Digital Output Complement.                 |
| 28      | DOUTH+ | ADC H Digital Output True.                       |
| 29      | DOUTG- | ADC G Digital Output Complement.                 |
| 30      | DOUTG+ | ADC G Digital Output True.                       |
| 31      | DOUTF- | ADC F Digital Output Complement.                 |
| 32      | DOUTF+ | ADC F Digital Output True.                       |
| 33      | DOUTE- | ADC E Digital Output Complement.                 |
| 34      | DOUTE+ | ADC E Digital Output True.                       |
| 35      | DCO-   | Digital Clock Output Complement.                 |
| 36      | DCO+   | Digital Clock Output True.                       |
| 37      | FCO-   | Digital Frame Clock Output Complement.           |
| 38      | FCO+   | Digital Frame Clock Output True.                 |
| 39      | DOUTD- | ADC D Digital Output Complement.                 |
| 40      | DOUTD+ | ADC D Digital Output True.                       |
| 41      | DOUTC- | ADC C Digital Output Complement.                 |
| 42      | DOUTC+ | ADC C Digital Output True.                       |
| 43      | DOUTB- | ADC B Digital Output Complement.                 |
| 44      | DOUTB+ | ADC B Digital Output True.                       |
| 45      | DOUTA- | ADC A Digital Output Complement.                 |
| 46      | DOUTA+ | ADC A Digital Output True.                       |
| 48      | STBY   | Standby Power-Down.                              |
| 49      | PDWN   | Full Power-Down.                                 |
| 51      | SCLK   | Serial Clock.                                    |
| 52      | SDIO   | Serial Data Input/Output.                        |
| 53      | CSB    | Chip Select Bar.                                 |
| 56      | LG-A   | LNA Ground for Channel A.                        |
| 57      | LI-A   | LNA Analog Input for Channel A.                  |
| 58      | LOSW-A | LNA Analog Switched Output for Channel A.        |
| 59      | LO-A   | LNA Analog Inverted Output for Channel A.        |
| 62      | LG-B   | LNA Ground for Channel B.                        |
| 63      | LI-B   | LNA Analog Input for Channel B.                  |
| 64      | LOSW-B | LNA Analog Switched Output for Channel B.        |
| 65      | LO-B   | LNA Analog Inverted Output for Channel B.        |
| 68      | LG-C   | LNA Ground for Channel C.                        |
| 69      | LI-C   | LNA Analog Input for Channel C.                  |
| 70      | LOSW-C | LNA Analog Switched Output for Channel C.        |
| 71      | LO-C   | LNA Analog Inverted Output for Channel C.        |
| 74      | LG-D   | LNA Ground for Channel D.                        |
| 75      | LI-D   | LNA Analog Input for Channel D.                  |
| 76      | LOSW-D | LNA Analog Switched Output for Channel D.        |
| 77      | LO-D   | LNA Analog Inverted Output for Channel D.        |
| 78      | GPO0   | General-Purpose Open-Drain Output 0.             |
| 79      | GPO1   | General-Purpose Open-Drain Output 1.             |
| 80      | GPO2   | General-Purpose Open-Drain Output 2.             |
| 81      | GPO3   | General-Purpose Open-Drain Output 3.             |
| 82      | RESET  | Reset for Synchronizing 4LO Divide-by-4 Counter. |
| 83      | 4LO-   | CW Doppler 4LO Input Complement.                 |
| 84      | 4LO+   | CW Doppler 4LO Input True.                       |
| 87      | GAIN-  | Gain Control Voltage Input Complement.           |
| 88      | GAIN+  | Gain Control Voltage Input True.                 |

| Pin No. | Name   | Description  |
|---------|--------|--|
| 89      | RBIAS  | External Resistor to Set the Internal ADC Core Bias Current. |
| 90      | VREF   | Voltage Reference Input/Output.                              |
| 92      | CWI-   | CW Doppler I Output Complement.                              |
| 93      | CWI+   | CW Doppler I Output True.                                    |
| 94      | CWQ-   | CW Doppler Q Output Complement.                              |
| 95      | CWQ+   | CW Doppler Q Output True.                                    |
| 99      | LO-E   | LNA Analog Inverted Output for Channel E.                    |
| 100     | LOSW-E | LNA Analog Switched Output for Channel E.                    |

# TYPICAL PERFORMANCE CHARACTERISTICS

## TGC MODE

$f_{\text{SAMPLE}} = 40 \text{ MSPS}$ ,  $f_{\text{IN}} = 5 \text{ MHz}$ ,  $R_s = 50 \Omega$ , LNA gain = 21.3 dB, LNA bias = high, PGA gain = 27 dB, AAF LPF cutoff =  $f_{\text{SAMPLE}}/3$ , HPF cutoff = LPF cutoff/20.7 (default).

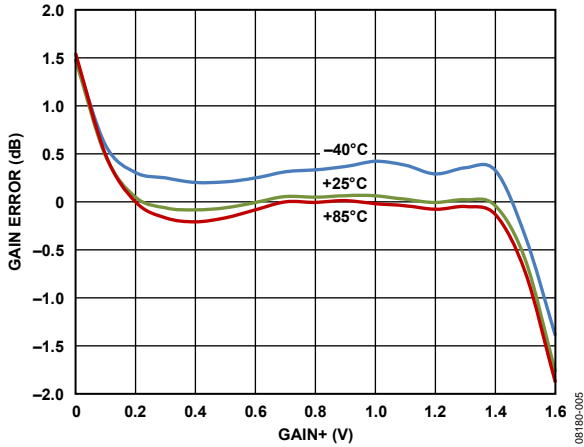

Figure 5. Gain Error vs. GAIN+ at Three Temperatures

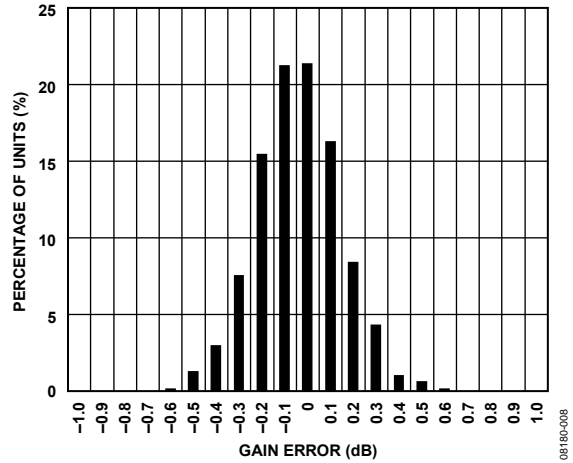

Figure 8. Gain Error Histogram, GAIN+ = 1.44 V

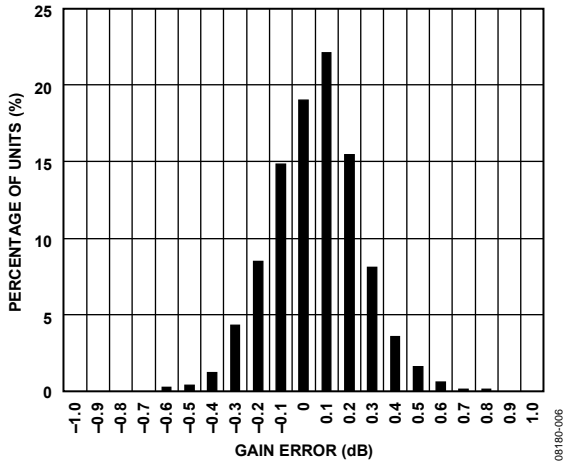

Figure 6. Gain Error Histogram, GAIN+ = 0.16 V

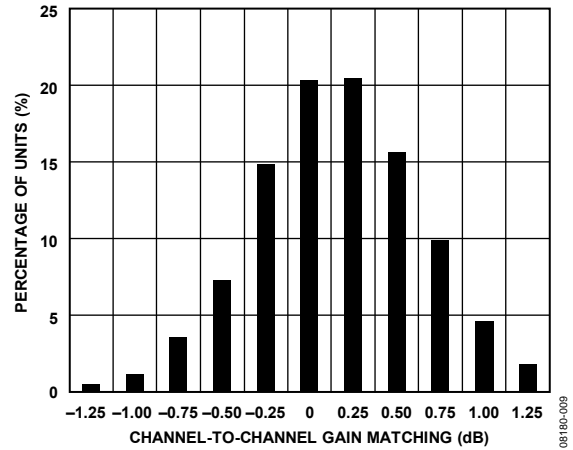

Figure 9. Gain Match Histogram, GAIN+ = 0.3 V

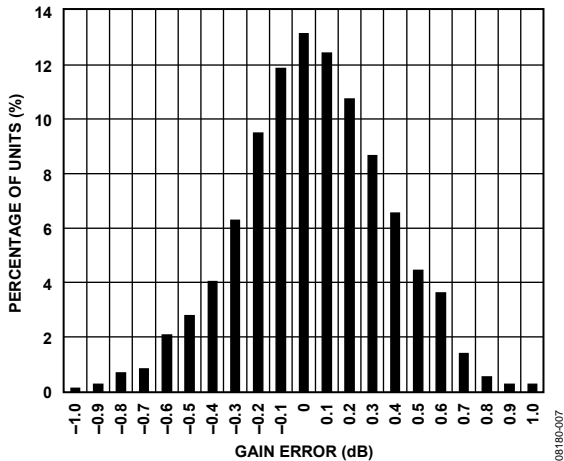

Figure 7. Gain Error Histogram, GAIN+ = 0.8 V

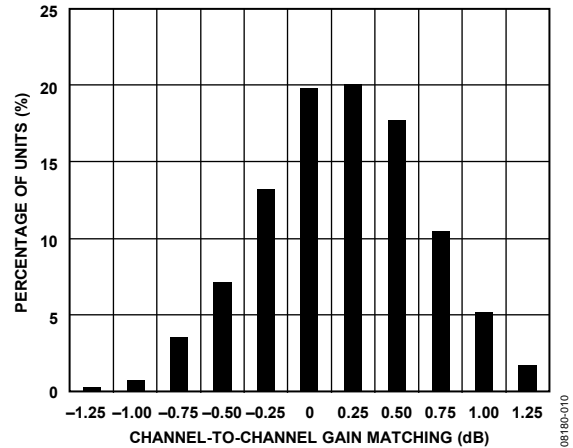

Figure 10. Gain Match Histogram, GAIN+ = 1.3 V

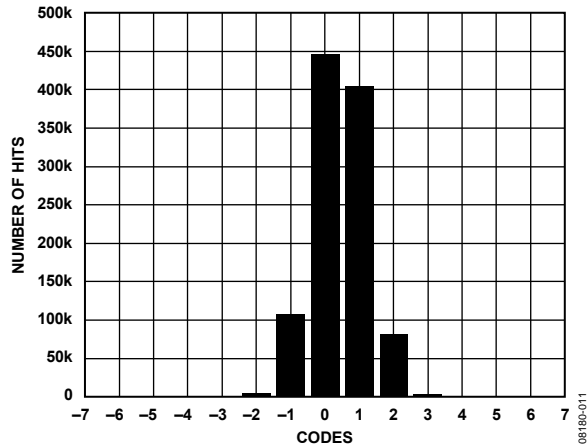

Figure 11. Output-Referred Noise Histogram, GAIN+ = 0.0 V

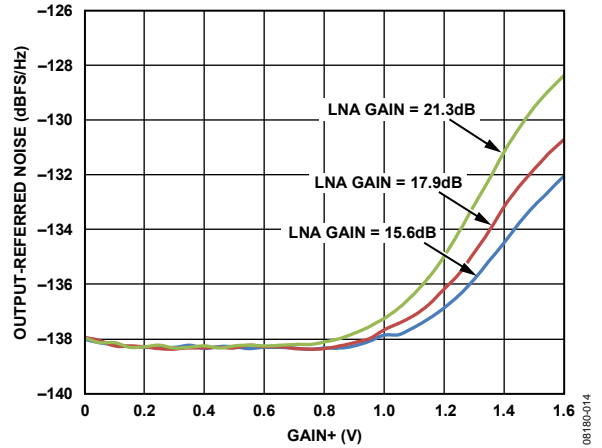

Figure 14. Short-Circuit, Output-Referred Noise vs. GAIN+

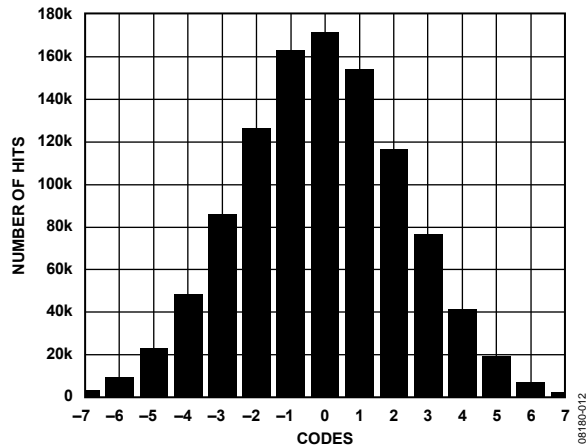

Figure 12. Output-Referred Noise Histogram, GAIN+ = 1.6 V

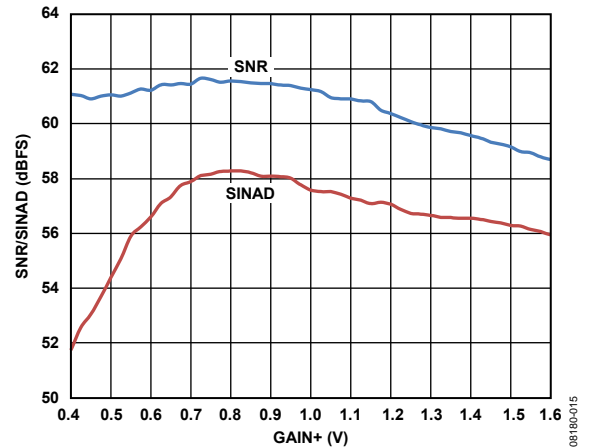

Figure 15. SNR/SINAD vs. GAIN+, AIN = -1.0 dBFS

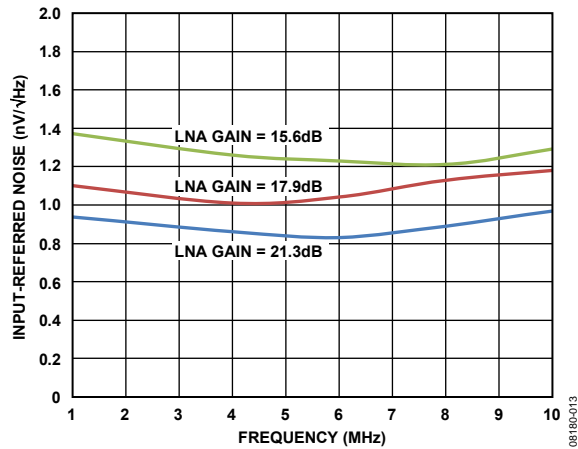

Figure 13. Short-Circuit, Input-Referred Noise vs. Frequency, PGA Gain = 30 dB, GAIN+ = 1.6 V

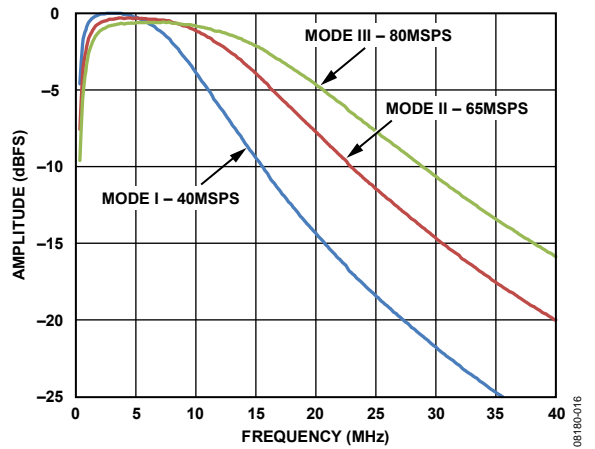

Figure 16. Antialiasing Filter (AAF) Pass-Band Response, LPF Cutoff =  $f_{SAMPLE}/3$  (Mode I and Mode II),  $f_{SAMPLE}/4.5$  (Mode III)

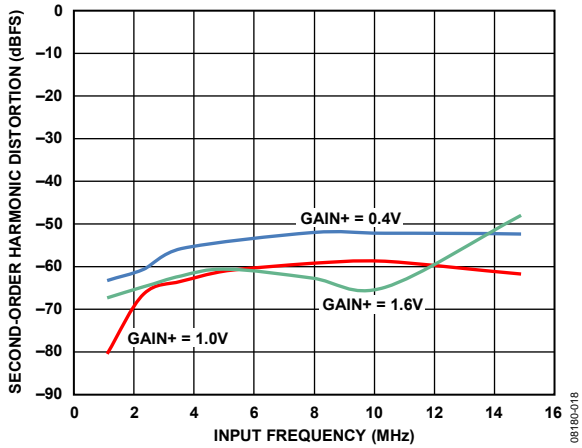

Figure 17. Second-Order Harmonic Distortion vs. Frequency, AIN = -1.0 dBFS

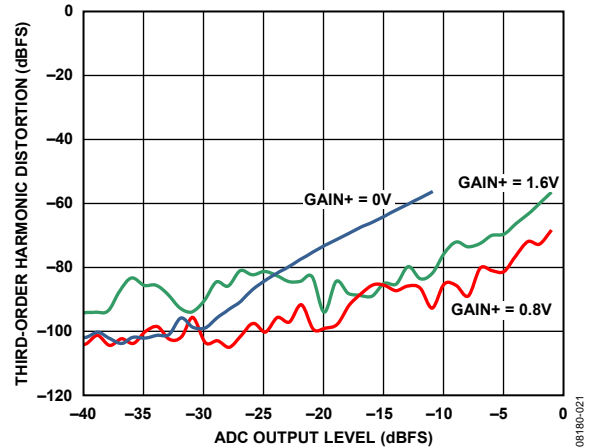

Figure 20. Third-Order Harmonic Distortion vs. ADC Output Level

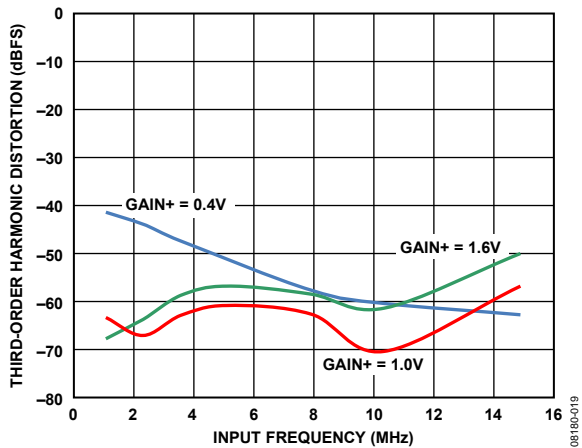

Figure 18. Third-Order Harmonic Distortion vs. Frequency, AIN = -1.0 dBFS

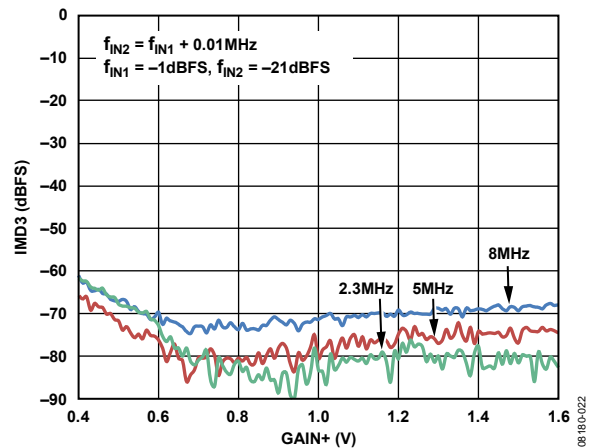

Figure 21. IMD3 vs. GAIN+

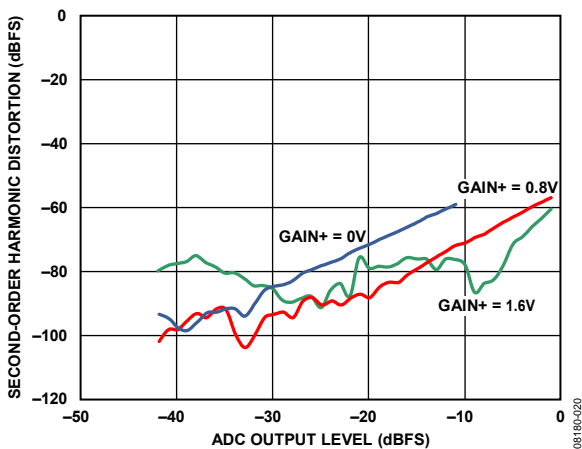

Figure 19. Second-Order Harmonic Distortion vs. ADC Output Level

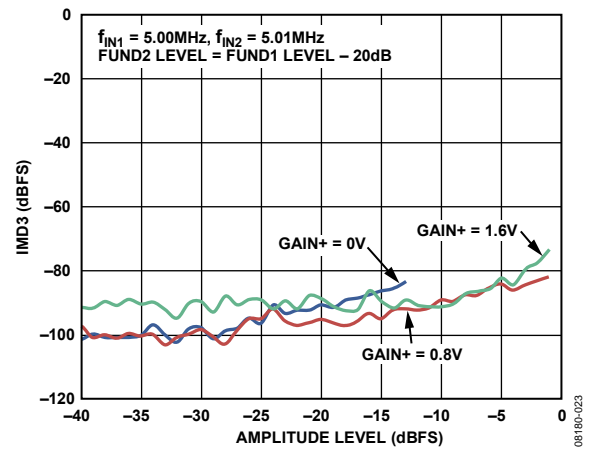

Figure 22. IMD3 vs. Amplitude Level



**CW DOPPLER MODE**

$f_{RF} = 2.5 \text{ MHz}$  at  $-3 \text{ dBFS}$ ,  $f_{LO} = 10 \text{ MHz}$ ,  $R_S = 50 \Omega$ , LNA gain =  $21.3 \text{ dB}$ , LNA bias = high, all CW channels enabled, phase rotation  $0^\circ$ .

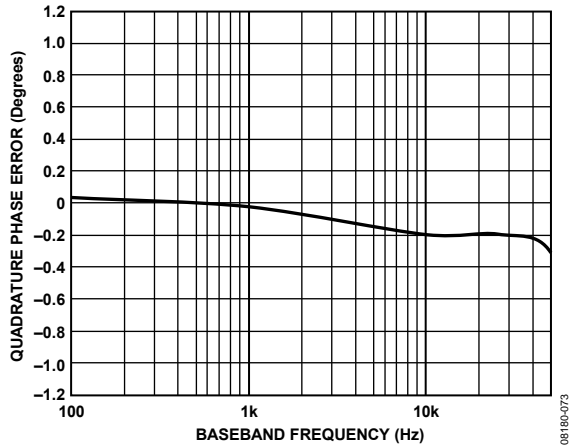

Figure 23. Quadrature Phase Error vs. Baseband Frequency

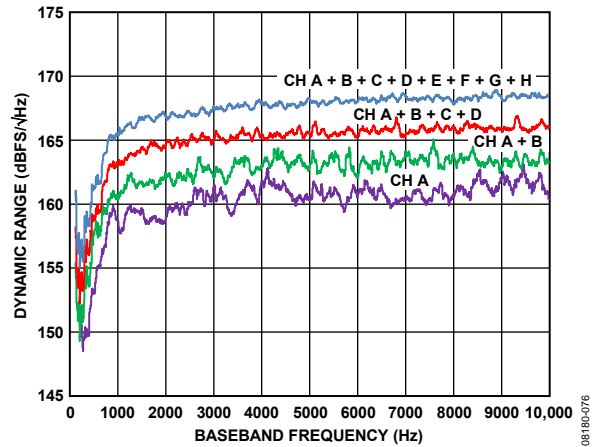

Figure 26. Small-Signal Dynamic Range

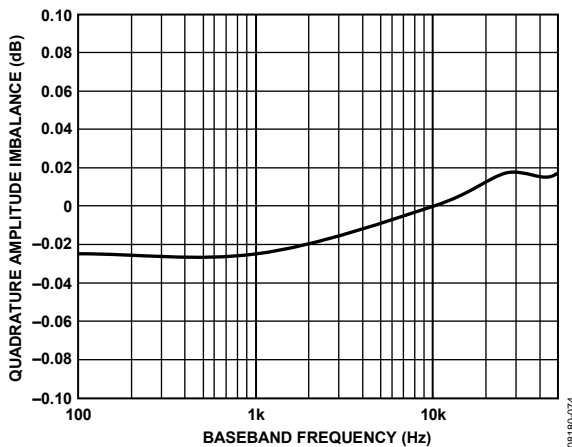

Figure 24. Quadrature Amplitude Imbalance vs. Baseband Frequency

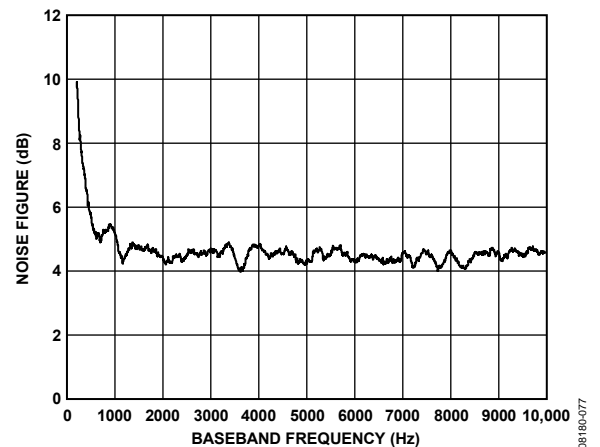

Figure 27. Noise Figure vs. Baseband Frequency

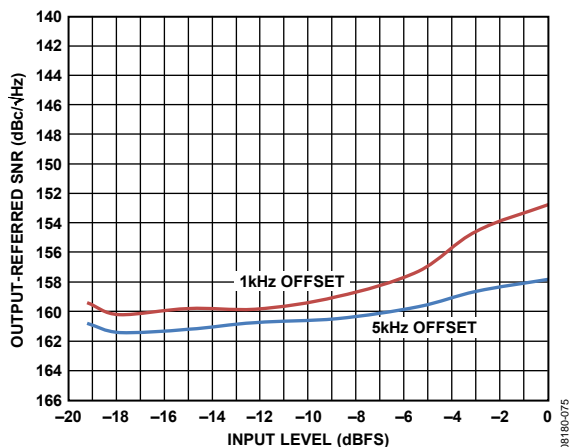

Figure 25. Output-Referred SNR vs. Input Level

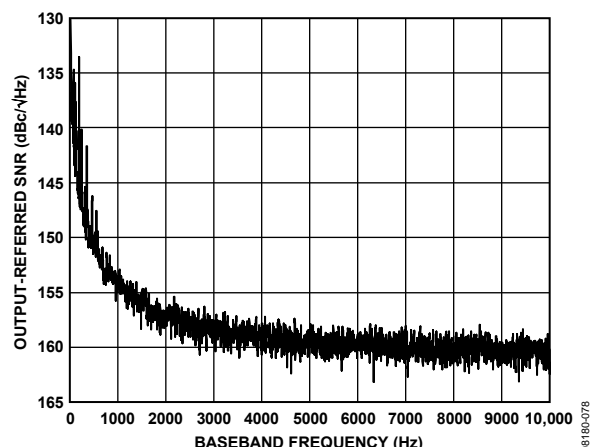

Figure 28. Output-Referred SNR vs. Baseband Frequency

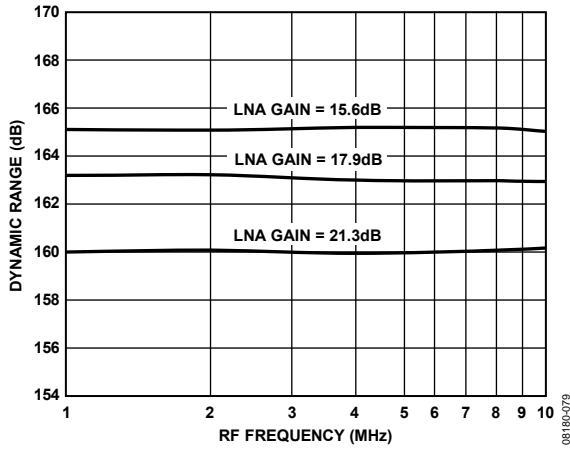

Figure 29. Small-Signal Dynamic Range vs. RF Frequency

08180-079

# EQUIVALENT CIRCUITS

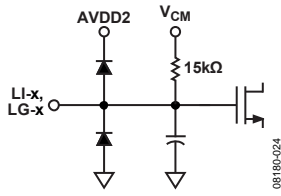

Figure 30. Equivalent LNA Input Circuit

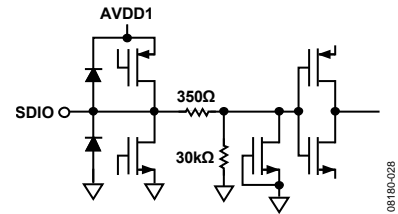

Figure 34. Equivalent SDIO Input Circuit

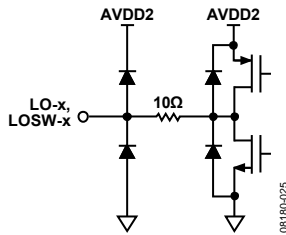

Figure 31. Equivalent LNA Output Circuit

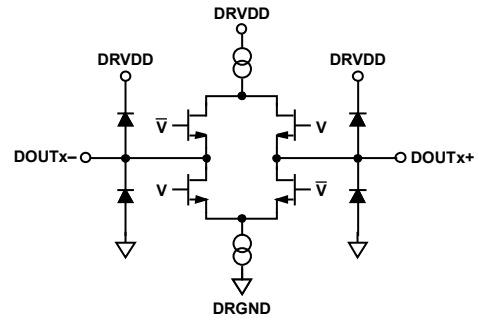

Figure 35. Equivalent Digital Output Circuit

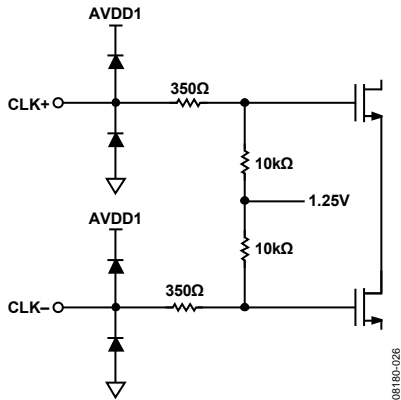

Figure 32. Equivalent Clock Input Circuit

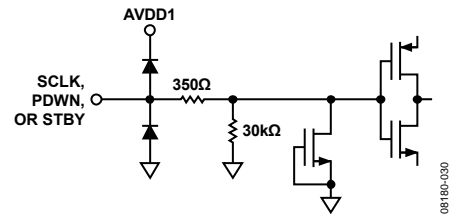

Figure 36. Equivalent SCLK, PDWN, or STBY Input Circuit

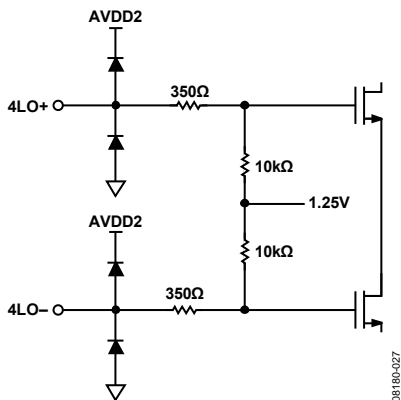

Figure 33. Equivalent 4LO Input Circuit

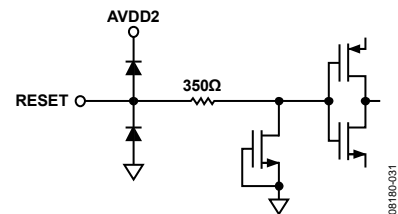

Figure 37. Equivalent RESET Input Circuit

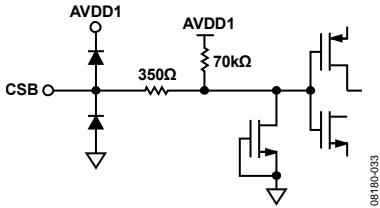

Figure 38. Equivalent CSB Input Circuit

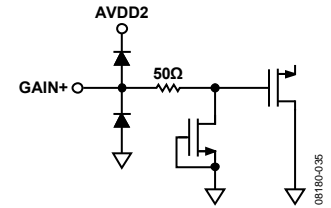

Figure 41. Equivalent GAIN+ Input Circuit

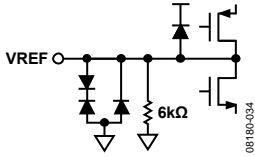

Figure 39. Equivalent VREF Circuit

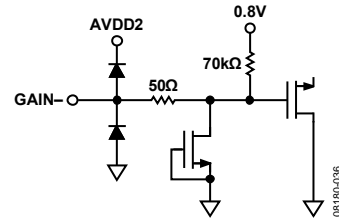

Figure 42. Equivalent GAIN- Input Circuit

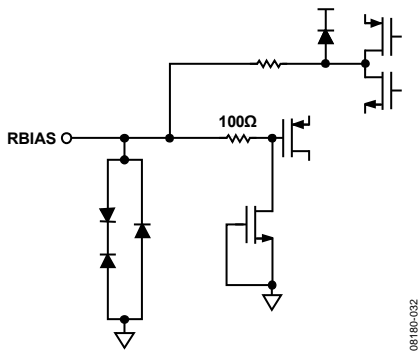

Figure 40. Equivalent RBIAS Circuit

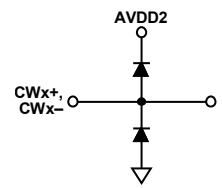

Figure 43. Equivalent CWI±, CWQ± Output Circuit

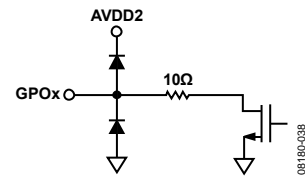

Figure 44. Equivalent GPOx Output Circuit

## THEORY OF OPERATION

### ULTRASOUND

The primary application for the AD9276 is medical ultrasound. Figure 45 shows a simplified block diagram of an ultrasound system. A critical function of an ultrasound system is the time gain control (TGC) compensation for physiological signal attenuation. Because the attenuation of ultrasound signals is exponential with respect to distance (time), a linear-in-dB VGA is the optimal solution.

Key requirements in an ultrasound signal chain are very low noise, active input termination, fast overload recovery, low power, and differential drive to an ADC. Because ultrasound machines use beamforming techniques requiring large binary-weighted numbers of channels (for example, 32 to 512), using the lowest power at the lowest possible noise is of chief importance.

Most modern ultrasound machines use digital beamforming. In this technique, the signal is converted to digital format immediately following the TGC amplifier, and then beamforming is accomplished digitally.

The ADC resolution of 12 bits with up to 80 MSPS sampling satisfies the requirements of both general-purpose and high end systems.

Power conservation and low cost are two of the most important factors in low end and portable ultrasound machines, and the AD9276 is designed to meet these criteria.

For additional information regarding ultrasound systems, refer to “How Ultrasound System Considerations Influence Front-End Component Choice,” *Analog Dialogue*, Volume 36, Number 3, May–July 2002, and “The AD9271—A Revolutionary Solution for Portable Ultrasound,” *Analog Dialogue*, Volume 41, Number 7, July 2007.

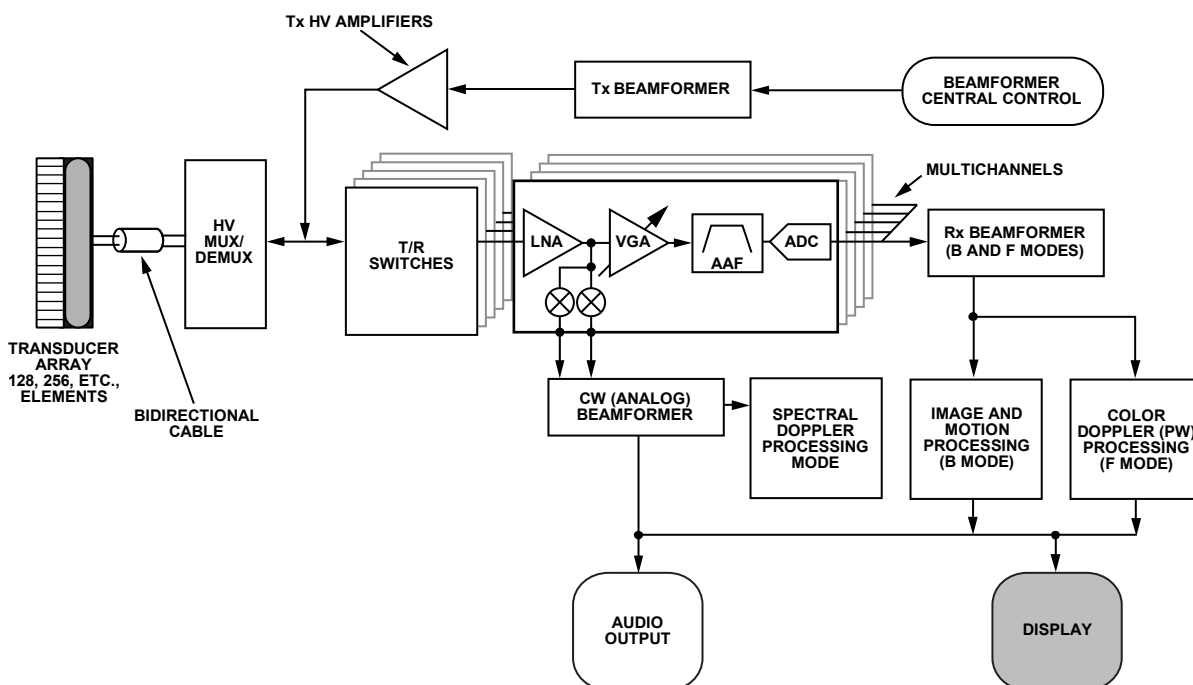

Figure 45. Simplified Ultrasound System Block Diagram

08160-039

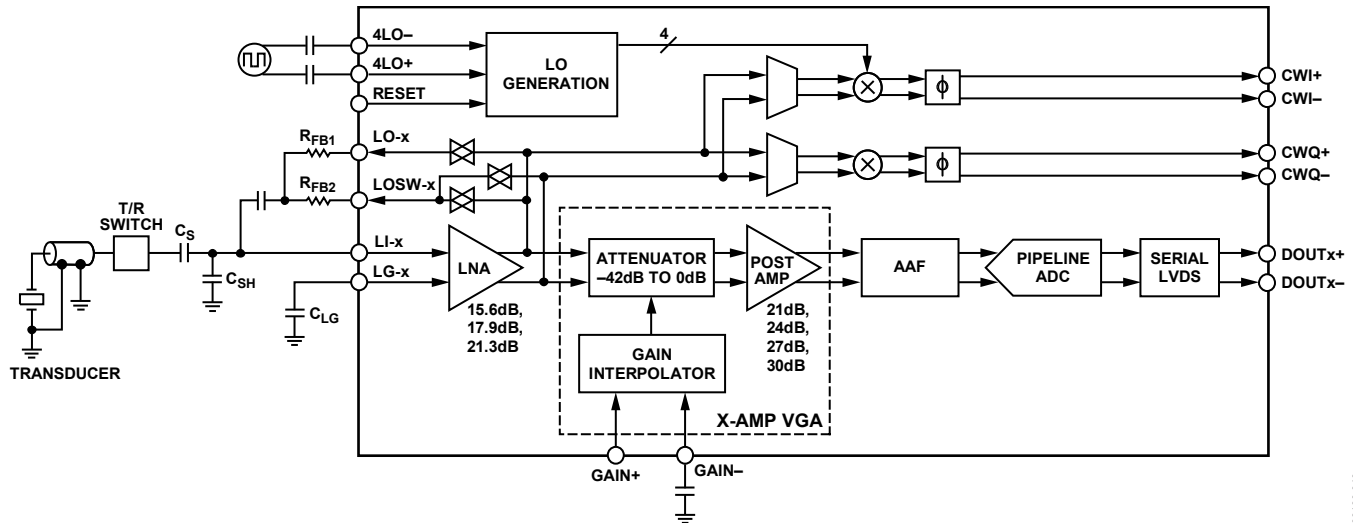

Figure 46. Simplified Block Diagram of a Single Channel

08180-040

## CHANNEL OVERVIEW

Each channel contains both a TGC signal path and a CW Doppler signal path. Common to both signal paths, the LNA provides user-adjustable input impedance termination. The CW Doppler path includes an I/Q demodulator. The TGC path includes a differential X-AMP<sup>®</sup> VGA, an antialiasing filter, and an ADC. Figure 46 shows a simplified block diagram with external components.

The signal path is fully differential throughout to maximize signal swing and reduce even-order distortion; however, the LNA is designed to be driven from a single-ended signal source.

### Low Noise Amplifier (LNA)

Good noise performance relies on a proprietary ultralow noise LNA at the beginning of the signal chain, which minimizes the noise contribution in the following VGA. Active impedance control optimizes noise performance for applications that benefit from input impedance matching.

A simplified schematic of the LNA is shown in Figure 47. LI-x is capacitively coupled to the source. An on-chip bias generator establishes dc input bias voltages of around 0.9 V and centers the output common-mode levels at 1.5 V ( $AVDD2$  divided by 2). A capacitor,  $C_{LG}$ , of the same value as the input coupling capacitor,  $C_s$ , is connected from the LG-x pin to ground.

It is highly recommended that the LG-x pins form a Kelvin type connection to the input or probe connection ground. Simply connecting the LG-x pin to ground near the device can allow differences in potential to be amplified through the LNA. This generally shows up as a dc offset voltage that can vary from channel to channel and part to part, depending on the application and the layout of the PCB.

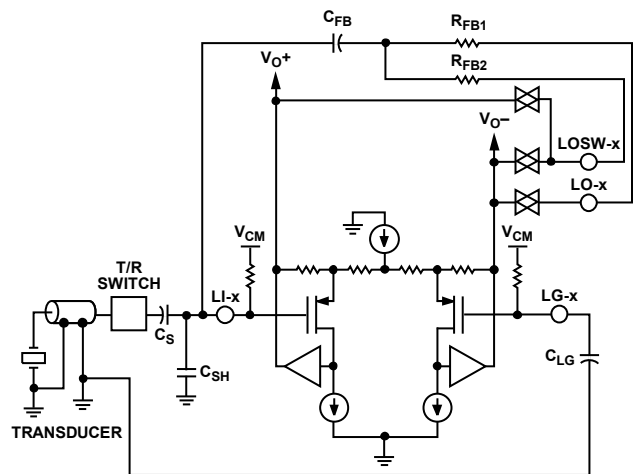

Figure 47. Simplified LNA Schematic

08180-041

The LNA supports differential output voltages as high as 4.4 V p-p with positive and negative excursions of  $\pm 1.1$  V from a common-mode voltage of 1.5 V. The LNA differential gain sets the maximum input signal before saturation. One of three gains is set through the SPI. The corresponding full-scale input for the gain settings of 15.6 dB, 17.9 dB, and 21.3 dB is 733 mV p-p, 550 mV p-p, and 367 mV p-p, respectively. Overload protection ensures quick recovery time from large input voltages. Because the inputs are capacitively coupled to a bias voltage near midsupply, very large inputs can be handled without interacting with the ESD protection.

Low value feedback resistors and the current-driving capability of the output stage allow the LNA to achieve a low input-referred noise voltage of  $0.75 \text{ nV}/\sqrt{\text{Hz}}$  (at a gain of 21.3 dB). This is achieved with a current consumption of only 27 mA per channel (80 mW). On-chip resistor matching results in precise single-ended gains, which are critical for accurate impedance control. The use of a fully differential topology and negative feedback minimizes distortion. Low second-order harmonic distortion is particularly important in second harmonic ultrasound imaging applications. Differential signaling enables smaller swings at each output, further reducing third-order harmonic distortion.

### Active Impedance Matching

The LNA consists of a single-ended voltage gain amplifier with differential outputs and the negative output externally available. For example, with a fixed gain of  $8\times$  (17.9 dB), an active input termination is synthesized by connecting a feedback resistor between the negative output pin, LO-x, and the positive input pin, LI-x. This well-known technique is used for interfacing multiple probe impedances to a single system. The input resistance is shown in Equation 1.

$$R_{IN} = \frac{R_{FB}}{(1 + A/2)} \quad (1)$$

where:

$A/2$  is the single-ended gain or the gain from the LI-x inputs to the LO-x outputs.

$R_{FB}$  is the resulting impedance of the  $R_{FB1}$  and  $R_{FB2}$  combination (see Figure 47).

Because the amplifier has a gain of  $8\times$  from its input to its differential output, it is important to note that the gain  $A/2$  is the gain from Pin LI-x to Pin LO-x and that it is 6 dB less than the gain of the amplifier, or 11.9 dB ( $4\times$ ). The input resistance is reduced by an internal bias resistor of 15 k $\Omega$  in parallel with the source resistance connected to Pin LI-x, with Pin LG-x ac grounded. Equation 2 can be used to calculate the required  $R_{FB}$  for a desired  $R_{IN}$ , even for higher values of  $R_{IN}$ .

$$R_{IN} = \frac{R_{FB}}{(1 + 3)} \parallel 15 \text{ k}\Omega \quad (2)$$

For example, to set  $R_{IN}$  to 200  $\Omega$ , the value of  $R_{FB}$  must be 1000  $\Omega$ . If the simplified equation (Equation 2) is used to calculate  $R_{IN}$ , the value is 188  $\Omega$ , resulting in a gain error of less than 0.6 dB. Some factors, such as the presence of a dynamic source resistance, may influence the absolute gain accuracy more significantly. At higher frequencies, the input capacitance of the LNA must be considered. The user must determine the level of matching accuracy and adjust  $R_{FB}$  accordingly.

The bandwidth (BW) of the LNA is greater than 100 MHz. Ultimately, the BW of the LNA limits the accuracy of the synthesized  $R_{IN}$ . For  $R_{IN} = R_S$  up to about 200  $\Omega$ , the best match is between 100 kHz and 10 MHz, where the lower frequency limit is determined by the size of the ac coupling capacitors, and the upper limit is determined by the LNA BW. Furthermore, the input capacitance and  $R_S$  limit the BW at higher frequencies. Figure 48 shows  $R_{IN}$  vs. frequency for various values of  $R_{FB}$ .

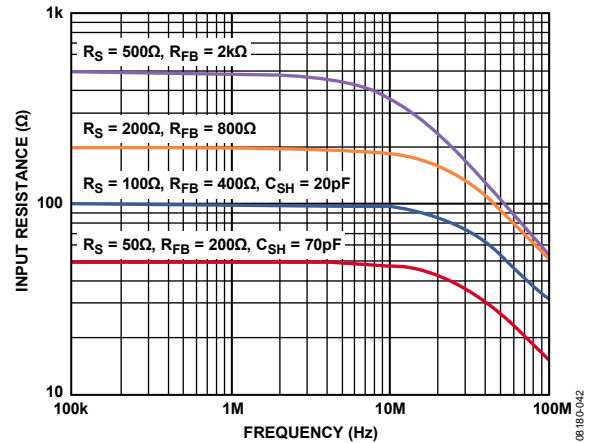

Figure 48.  $R_{IN}$  vs. Frequency for Various Values of  $R_{FB}$  (Effects of  $R_S$  and  $C_{SH}$  Are Also Shown)

Note that at the lowest value of  $R_{IN}$  (50  $\Omega$ ),  $R_{IN}$  peaks at frequencies greater than 10 MHz. This is due to the BW roll-off of the LNA, as mentioned previously.

However, as can be seen for larger  $R_{IN}$  values, parasitic capacitance starts rolling off the signal BW before the LNA can produce peaking.  $C_{SH}$  further degrades the match; therefore,  $C_{SH}$  should not be used for values of  $R_{IN}$  that are greater than 100  $\Omega$ . Table 7 lists the recommended values for  $R_{FB}$  and  $C_{SH}$  in terms of  $R_{IN}$ .

$C_{FB}$  is needed in series with  $R_{FB}$  because the dc levels at Pin LO-x and Pin LI-x are unequal.

Table 7. Active Termination External Component Values

| LNA Gain (dB) | $R_{IN}$ ( $\Omega$ ) | $R_{FB}$ ( $\Omega$ ) | Minimum $C_{SH}$ (pF) | BW (MHz) |
|---------------|-----------------------|-----------------------|-----------------------|----------|
| 15.6          | 50                    | 200                   | 90                    | 57       |
| 17.9          | 50                    | 250                   | 70                    | 69       |
| 21.3          | 50                    | 350                   | 50                    | 88       |
| 15.6          | 100                   | 400                   | 30                    | 57       |
| 17.9          | 100                   | 500                   | 20                    | 69       |
| 21.3          | 100                   | 700                   | 10                    | 88       |
| 15.6          | 200                   | 800                   | N/A                   | 72       |
| 17.9          | 200                   | 1000                  | N/A                   | 72       |
| 21.3          | 200                   | 1400                  | N/A                   | 72       |

**LNA Noise**

The short-circuit noise voltage (input-referred noise) is an important limit on system performance. The short-circuit noise voltage for the LNA is 0.75 nV/√Hz at a gain of 21.3 dB, including the VGA noise at a VGA postamp gain of 27 dB. These measurements, which were taken without a feedback resistor, provide the basis for calculating the input noise and noise figure (NF) performance of the configurations shown in Figure 49.

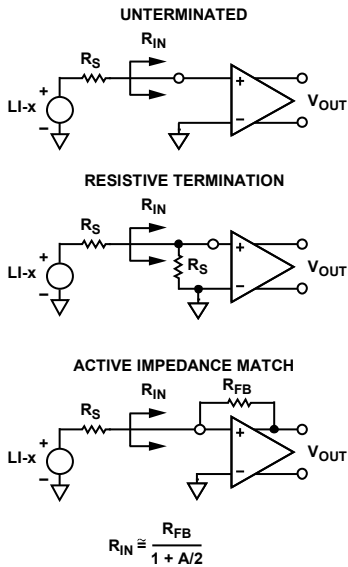

Figure 49. Input Configurations

Figure 50 and Figure 51 are simulations of noise figure vs.  $R_s$  results using these configurations and an input-referred noise voltage of 3.8 nV/√Hz for the VGA. Unterminated ( $R_{FB} = \infty$ ) operation exhibits the lowest equivalent input noise and noise figure. Figure 51 shows the noise figure vs. source resistance rising at low  $R_s$ —where the LNA voltage noise is large compared with the source noise—and at high  $R_s$  due to the noise contribution from  $R_{FB}$ . The lowest NF is achieved when  $R_s$  matches  $R_{IN}$ .

The main purpose of input impedance matching is to improve the transient response of the system. With resistive termination, the input noise increases due to the thermal noise of the matching resistor and the increased contribution of the LNA's input voltage noise generator. With active impedance matching, however, the contributions of both are smaller (by a factor of  $1/(1 + \text{LNA gain})$ ) than they would be for resistive termination.

Figure 50 shows the relative noise figure performance. With an LNA gain of 21.3 dB, the input impedance was swept with  $R_s$  to preserve the match at each point. The noise figures for a source impedance of 50 Ω are 7.3 dB, 4.2 dB, and 2.8 dB for the resistive termination, active termination, and unterminated configurations, respectively. The noise figures for 200 Ω are 4.5 dB, 1.7 dB, and 1.0 dB, respectively.

Figure 51 shows the noise figure as it relates to  $R_s$  for various values of  $R_{IN}$ , which is helpful for design purposes.

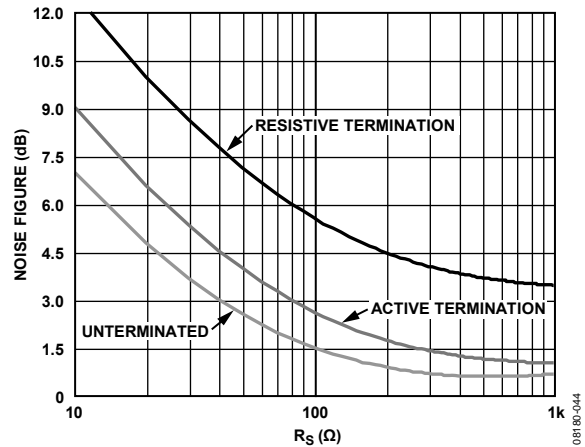

Figure 50. Noise Figure vs.  $R_s$  for Resistive Termination, Active Termination Matched, and Unterminated Inputs,  $V_{GAIN} = 0.8 V$

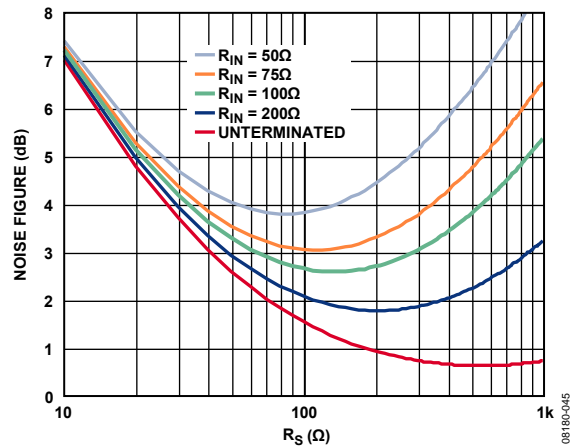

Figure 51. Noise Figure vs.  $R_s$  for Various Fixed Values of  $R_{IN}$ , Active Termination Matched Inputs,  $V_{GAIN} = 0.8 V$



## INPUT OVERDRIVE

Excellent overload behavior is of primary importance in ultrasound. Both the LNA and VGA have built-in overdrive protection and quickly recover after an overload event.

### Input Overload Protection

As with any amplifier, voltage clamping prior to the inputs is highly recommended if the application is subject to high transient voltages.

Figure 52 shows a simplified ultrasound transducer interface. A common transducer element serves the dual functions of transmitting and receiving ultrasound energy. During the transmitting phase, high voltage pulses are applied to the ceramic elements. A typical transmit/receive (T/R) switch can consist of four high voltage diodes in a bridge configuration. Although the diodes ideally block transmit pulses from the sensitive receiver input, diode characteristics are not ideal, and the resulting leakage transients imposed on the LI-x inputs can be problematic.

Because ultrasound is a pulse system and time-of-flight is used to determine depth, quick recovery from input overloads is essential. Overload can occur in the preamplifier and in the VGA. Immediately following a transmit pulse, the typical VGA gains are low, and the LNA is subject to overload from T/R switch leakage. With increasing gain, the VGA can become overloaded due to strong echoes that occur near field echoes and acoustically dense materials, such as bone.

Figure 52 illustrates an external overload protection scheme. A pair of back-to-back signal diodes should be in place prior to the ac coupling capacitors. Keep in mind that all diodes are prone to exhibiting some amount of shot noise. Many types of diodes are available for achieving the desired noise performance. The configuration shown in Figure 52 tends to add  $2 \text{ nV}/\sqrt{\text{Hz}}$  of input-referred noise. Decreasing the  $5 \text{ k}\Omega$  resistor and increasing the  $2 \text{ k}\Omega$  resistor may improve noise contribution, depending on the application. With the diodes shown in Figure 52, clamping levels of  $\pm 0.5 \text{ V}$  or less significantly enhance the overload performance of the system.

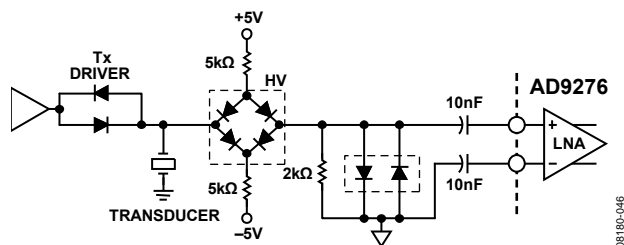

Figure 52. Input Overload Protection

## CW DOPPLER OPERATION

Each channel of the AD9276 includes an I/Q demodulator. Each demodulator has an individual programmable phase shifter. The I/Q demodulator is ideal for phased array beamforming applications in medical ultrasound. Each channel can be programmed for 16 delay states ( $360^\circ/16$  or  $22.5^\circ/\text{step}$ ), selectable via the SPI port. The part has a RESET input used to synchronize the LO dividers of each channel. If multiple AD9276s are used, a common RESET across the array ensures synchronized phase for all channels. Internal to the AD9276, the individual channel I and Q outputs are current summed. If multiple AD9276s are used, the I and Q outputs from each AD9276 can be current summed and converted to a voltage using an external transimpedance amplifier.

### Quadrature Generation

The internal  $0^\circ$  and  $90^\circ$  LO phases are digitally generated by a divide-by-4 logic circuit. The divider is dc-coupled and inherently broadband; the maximum LO frequency is limited only by its switching speed. The duty cycle of the quadrature LO signals is intrinsically 50% and is unaffected by the asymmetry of the externally connected 4LO input. Furthermore, the divider is implemented such that the 4LO signal reclocks the final flip-flops that generate the internal LO signals and thereby minimizes noise introduced by the divide circuitry.

For optimum performance, the 4LO input is driven differentially, as done on the AD9276 evaluation board. The common-mode voltage on each pin is approximately 1.2 V with the nominal 3 V supply. It is important to ensure that the LO source has very low phase noise (jitter), fast slew rate, and adequate input level to obtain optimum performance of the CW signal chain.

Beamforming applications require a precise channel-to-channel phase relationship for coherence among multiple channels. A RESET pin is provided to synchronize the LO divider circuits in different AD9276s when they are used in arrays. The RESET pin resets the dividers to a known state after power is applied to multiple AD9276s. Accurate channel-to-channel phase matching can only be achieved via a common pulse on the RESET pin when using more than one AD9276.

## I/Q Demodulator and Phase Shifter

The I/Q demodulators consist of double-balanced passive mixers. The RF input signals are converted into currents by transconductance stages that have a maximum differential input signal capability matching the LNA output full scale. These currents are then presented to the mixers, which convert them to baseband (RF – LO) and twice RF (RF + LO). The signals are phase shifted according to the codes programmed into the SPI latch (see Table 8). The phase shift function is an integral part of the overall circuit. The phase shift listed in Column 1 of Table 8 is defined as being between the baseband I or Q channel outputs. As an example, for a common signal applied to a pair of RF inputs to an AD9276, the baseband outputs are in phase for matching phase codes. However, if the phase code for Channel 1 is 0000 and that of Channel 2 is 0001, then Channel 2 leads Channel 1 by 22.5°.

**Table 8. Phase Select Code for Channel-to-Channel Phase Shift**

| Φ Shift | I/Q Demodulator Phase (SPI Register 0x2D[3:0]) |
|---------|--|
| 0°      | 0000   |
| 22.5°   | 0001   |
| 45°     | 0010   |
| 67.5°   | 0011   |
| 90°     | 0100   |
| 112.5°  | 0101   |
| 135°    | 0110   |
| 157.5°  | 0111   |
| 180°    | 1000   |
| 202.5°  | 1001   |
| 225°    | 1010   |
| 247.5°  | 1011   |
| 270°    | 1100   |
| 292.5°  | 1101   |
| 315°    | 1110   |
| 337.5°  | 1111   |

## Dynamic Range and Noise

Figure 53 is an interconnection block diagram of all eight channels of the AD9276. More channels are easily added to the summation (up to 32 when using an AD8021 as the summation amplifier) by wire-OR connecting the outputs as shown. In beamforming applications, the I and Q outputs of a number of receiver channels are summed. The dynamic range of the system increases by the factor  $10 \log_{10}(N)$ , where N is the number of channels (assuming random uncorrelated noise). The noise in the 8-channel example of Figure 53 is increased by 9 dB, whereas the signal quadruples (18 dB), yielding an aggregate SNR improvement of  $(18 - 9) = 9$  dB.

The output-referred noise of the CW signal path depends on the LNA gain, the selection of the external summing amplifier, and the value of  $R_{FILT}$ . To determine the output-referred noise, it is important to know the active low-pass filter (LPF) values,  $R_{FILT}$  and  $C_{FILT}$ , shown in Figure 53. Typical filter values for a single channel are 2 kΩ for  $R_{FILT}$  and 0.8 nF for  $C_{FILT}$ ; these values implement a 100 kHz single-pole LPF. In the case where eight channels are summed,  $R_{FILT}$  and  $C_{FILT}$  are 250 Ω and 6.4 nF.

If the RF and LO are offset by 10 kHz, the demodulated signal is 10 kHz and is passed by the LPF. The single-channel mixing gain from the RF input to the AD8021 output (for example, I1', Q1') is approximately the LNA gain for  $R_{FILT}$  and  $C_{FILT}$  of 2 kΩ and 0.8 nF.

This gain can be increased by increasing the filter resistor while maintaining the corner frequency. The factor limiting the magnitude of the gain is the output swing and drive capability of the op amp selected for the I-to-V converter, in this example, the AD8021. Because any amplifier has limited drive capability, there is a finite number of channels that can be summed. The channel-summing limit relates directly to the current drive capability of the amplifier used to implement the active low-pass filter and current-to-voltage converter. The maximum sum, when the AD8021 is used, is 32 channels of the AD9276; that is, four AD9276s ( $4 \times 8 = 32$  channels) can be summed in one AD8021.

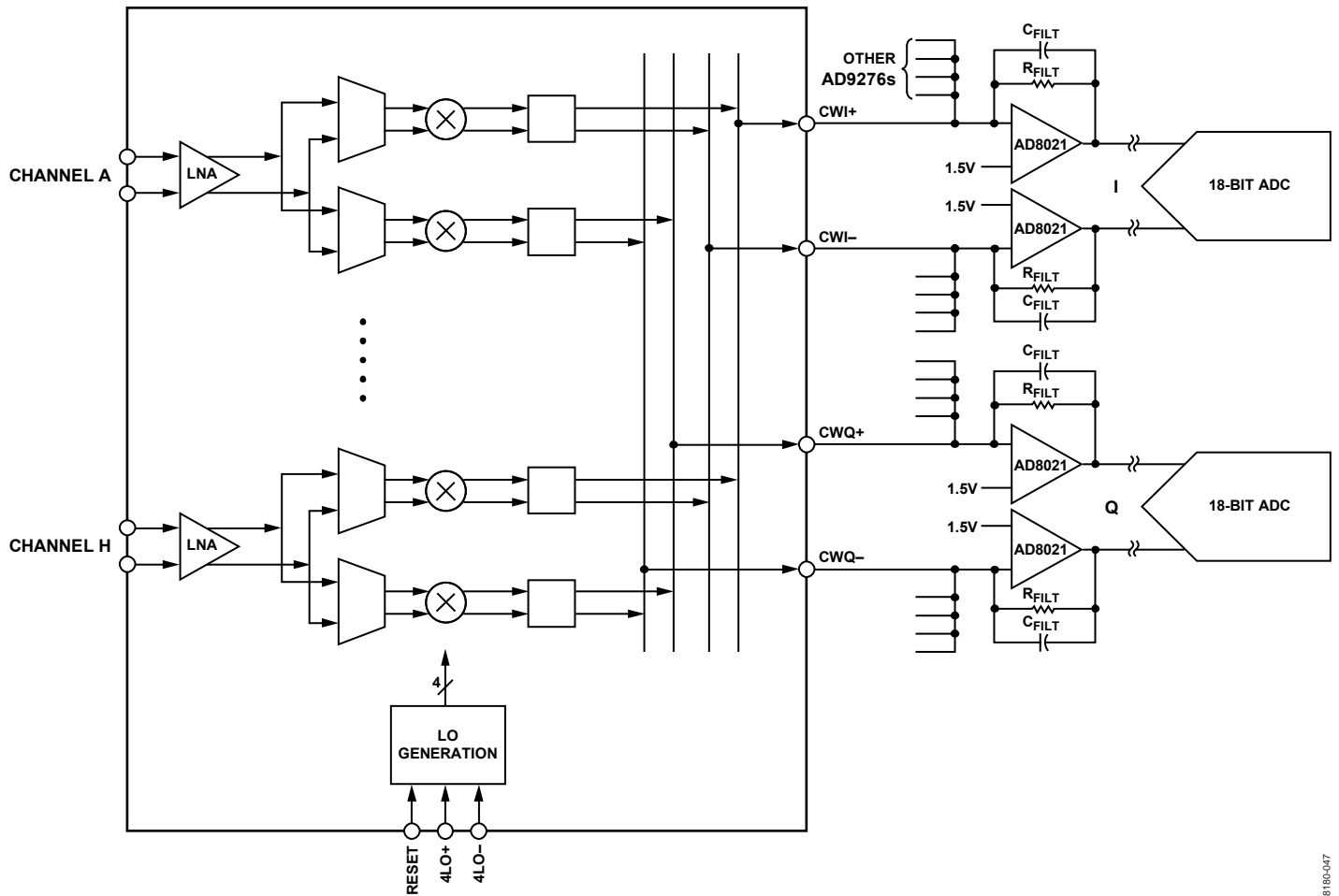

Figure 53. Typical Connection Interface for I/Q Outputs in CW Mode

### Phase Compensation and Analog Beamforming

Beamforming, as applied to medical ultrasound, is defined as the phase alignment and summation of signals generated from a common source but received at different times by a multielement ultrasound transducer. Beamforming has two functions: it imparts directivity to the transducer, enhancing its gain, and it defines a focal point within the body from which the location of the returning echo is derived. The primary application for the AD9276 I/Q demodulators is in analog beamforming circuits for ultrasound CW Doppler.

Modern ultrasound machines used for medical applications employ an array of receivers for beamforming, with typical CW Doppler array sizes of up to 64 receiver channels that are phase shifted and summed together to extract coherent information. When used in multiples, the desired signals from each of the channels can be summed to yield a larger signal (increased by a factor  $N$ , where  $N$  is the number of channels), whereas the noise is increased by the square root of the number of channels. This technique enhances the signal-to-noise performance of the machine. The critical elements in a beamformer design are the means to align the incoming signals in the time domain and the means to sum the individual signals into a composite whole.

In traditional analog beamformers incorporating Doppler, a V-to-I converter per channel and a crosspoint switch precede passive delay lines used as a combined phase shifter and summing circuit. The system operates at the carrier frequency (RF) through the delay line, which also sums the signals from the various channels, and then the combined signal is down-converted by an I/Q demodulator. The dynamic range of the demodulator can limit the achievable dynamic range.

The resultant I and Q signals are filtered and then sampled by two high resolution analog-to-digital converters. The sampled signals are processed to extract the relevant Doppler information.

Alternatively, the RF signal can be processed by downconversion on each channel individually, phase shifting the downconverted signal and then combining all channels. Because the dynamic range expansion from beamforming occurs after demodulation, the demodulator dynamic range has little effect on the output dynamic range. The AD9276 implements this architecture. The downconversion is done by an I/Q demodulator on each channel, and the summed current output is the same as in the delay line approach. The subsequent filters after the I-to-V conversion and the ADCs are similar.

For CW Doppler operation, the AD9276 integrates the LNA, phase shifter, frequency conversion, and I/Q demodulation into a single package and directly yields the baseband signal. Figure 54 is a simplified diagram showing the concept for four channels. The ultrasound wave (US wave) is received by four transducer elements, TE1 through TE4, in an ultrasound probe and generates signals E1 through E4. In this example, the phase at TE1 leads the phase at TE2 by 45°.

In a real application, the phase difference depends on the element spacing, wavelength ( $\lambda$ ), speed of sound, angle of incidence, and other factors. In Figure 54, the signals E1 through E4 are amplified by the low noise amplifiers. For optimum signal-to-noise performance, the output of the LNA is applied directly to the input of the demodulators. To sum the signals E1 through E4, E2 is shifted 45° relative to E1 by setting the phase code in Channel 2 to 0010, E3 is shifted 90° (0100), and E4 is shifted 135° (0110). The phase-aligned current signals at the output of the AD9276 are summed in an I-to-V converter to provide the combined output signal with a theoretical improvement in dynamic range of 6 dB for the four channels.

### CW Application Information

The RESET pin is used to synchronize the LO dividers when using multiple AD9276s. Because they are driven by the same internal LO, the channels in any AD9276 are inherently synchronous. However, when multiple AD9276s are used, it is possible for their dividers to wake up in different phase states. The function of the RESET pin is to phase align all the LO signals in multiple AD9276s.

The 4LO divider of each AD9276 can be initiated in one of four possible states: 0°, 90°, 180°, and 270° relative to other AD9276s. The internally generated I/Q signals of each AD9276 LO are always at a 90° angle relative to each other, but a phase shift can occur during power-up between the dividers of multiple AD9276s used in a common array.

The RESET mechanism also allows the measurement of non-mixing gain from the RF input to the output. The rising edge of the active high RESET pulse can occur at any time; however, the duration should be  $\geq 20$  ns minimum. When the RESET pulse transitions from high to low, the LO dividers are reactivated on the next rising edge of the 4LO clock. To guarantee synchronous operation of multiple AD9276s, the RESET pulse must go low on all devices before the next rising edge of the 4LO clock.

Therefore, it is best to have the RESET pulse go low on the falling edge of the 4LO clock; at the very least, the  $t_{\text{SETUP}}$  should be  $\geq 5$  ns. An optimal timing setup is for the RESET pulse to go high on a 4LO falling edge and to go low on a 4LO falling edge; this gives 15 ns of setup time even at a 4LO frequency of 32 MHz (8 MHz internal LO).

Check the synchronization of multiple AD9276s using the following procedure:

1. Activate at least one channel per AD9276 by setting the appropriate channel enable bit in the serial interface (see Table 18, Register 0x2D, Bit 4).
2. Set the phase code of all AD9276 channels to the same logic state, for example, 0000.
3. Apply the same test signal to all devices to generate a sine wave in the baseband output and measure the output of one channel per device.
4. Apply a RESET pulse to all AD9276s.
5. Because all the phase codes of the AD9276s should be the same, the combined signal of multiple devices should be N times greater than a single channel. If the combined signal is less than N times one channel, one or more of the LO phases of the individual AD9276s is in error.

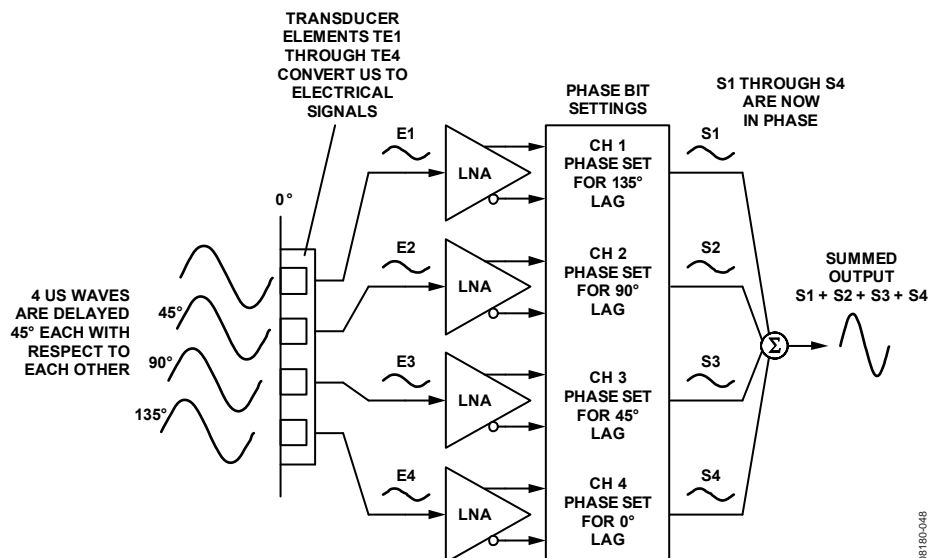

Figure 54. Simplified Example of the AD9276 Phase Shifter

**TGC OPERATION**

The TGC signal path is fully differential throughout to maximize signal swing and reduce even-order distortion; however, the LNAs are designed to be driven from a single-ended signal source. Gain values are referenced from the single-ended LNA input to the differential ADC input. A simple exercise in understanding the maximum and minimum gain requirements is shown in Figure 55.

The maximum gain required is determined by

$$(ADC\ Noise\ Floor/LNA\ Input\ Noise\ Floor) + Margin = 20 \log(224/3.9) + 11\ dB = 46\ dB$$

The minimum gain required is determined by

$$(ADC\ Input\ FS/LNA\ Input\ FS) + Margin = 20 \log(2/0.55) - 10\ dB = 3\ dB$$

Therefore, 42 dB of gain range for a 12-bit, 40 MSPS ADC with 15 MHz of bandwidth should suffice in achieving the dynamic range required for most of today’s ultrasound systems.

The system gain is distributed as listed in Table 9.

**Table 9. Channel Gain Distribution**

| Section       | Nominal Gain (dB) |
|---------------|-------------------|
| LNA           | 15.6/17.9/21.3    |
| Attenuator    | -42 to 0          |
| VGA Amplifier | 21/24/27/30       |
| Filter        | 0                 |
| ADC           | 0                 |

The linear-in-dB gain (law conformance) range of the TGC path is 42 dB. The slope of the gain control interface is 28.5 dB/V, and the gain control range is -0.8 V to +0.8 V. Equation 3 is the expression for the differential voltage  $V_{GAIN}$ , and Equation 4 is the expression for the channel gain.

$$V_{GAIN} (V) = (GAIN+) - (GAIN-) \tag{3}$$

$$Gain (dB) = 28.5\ dB/V \times V_{GAIN} + ICPT \tag{4}$$

where  $ICPT$  is the intercept point of the TGC gain.

In its default condition, the LNA has a gain of 21.3 dB (12×), and the VGA postamp gain is 24 dB if the voltage on the GAIN+ pin is 0 V and the voltage on the GAIN- pin is 0.8 V (42 dB attenuation). This results in a total gain (or ICPT) of 3.6 dB through the TGC path if the LNA input is unmatched, or a total gain of -2.4 dB if the LNA is matched to 50 Ω ( $R_{FB} = 350\ \Omega$ ). However, if the voltage on the GAIN+ pin is 1.6 V and the voltage on the GAIN- pin is 0.8 V (0 dB attenuation), the VGA gain is 24 dB. This results in a total gain of 45 dB through the TGC path if the LNA input is unmatched or in a total gain of 39 dB if the LNA input is matched.

Each LNA output is dc-coupled to a VGA input. The VGA consists of an attenuator with a range of -42 dB to 0 dB followed by an amplifier with 21 dB/24 dB/27 dB/30 dB of gain. The X-AMP gain interpolation technique results in low gain error and uniform bandwidth, and differential signal paths minimize distortion.

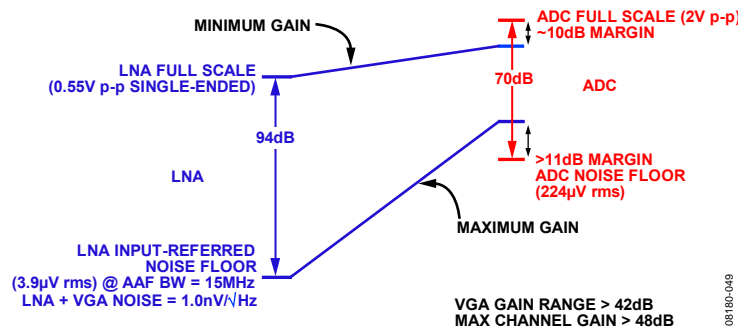

Figure 55. Gain Requirements of TGC Operation for a 12-Bit, 40 MSPS ADC

# AD9276

**Table 10. Sensitivity and Dynamic Range Trade-Offs<sup>1, 2, 3</sup>**

| Gain  |      | LNA                      |                                       | VGA               | Channel                           |                            |   |
|-------|------|--------------------------|---------------------------------------|-------------------|-----------------------------------|----------------------------|---|
| (V/V) | (dB) | Full-Scale Input (V p-p) | Input Noise (nV/ $\sqrt{\text{Hz}}$ ) | Postamp Gain (dB) | Typical Output Dynamic Range (dB) |                            | Input-Referred Noise <sup>6</sup> @ GAIN+ = 1.6 V (nV/ $\sqrt{\text{Hz}}$ ) |
|       |      |                          |                                       |                   | GAIN+ = 0 V <sup>4</sup>          | GAIN+ = 1.6 V <sup>5</sup> |   |
| 6     | 15.6 | 0.733                    | 0.98                                  | 21                | 67.5                              | 65.1                       | 1.395   |
|       |      |                          |                                       | 24                | 66.4                              | 63.0                       | 1.286   |
|       |      |                          |                                       | 27                | 64.6                              | 60.6                       | 1.227   |
|       |      |                          |                                       | 30                | 62.5                              | 57.9                       | 1.197   |
| 8     | 17.9 | 0.550                    | 0.86                                  | 21                | 67.5                              | 64.5                       | 1.149   |
|       |      |                          |                                       | 24                | 66.4                              | 62.3                       | 1.071   |
|       |      |                          |                                       | 27                | 64.6                              | 59.8                       | 1.030   |
|       |      |                          |                                       | 30                | 62.5                              | 57.1                       | 1.009   |
| 12    | 21.3 | 0.367                    | 0.75                                  | 21                | 67.5                              | 63.3                       | 0.910   |
|       |      |                          |                                       | 24                | 66.4                              | 60.9                       | 0.865   |
|       |      |                          |                                       | 27                | 64.6                              | 58.2                       | 0.842   |
|       |      |                          |                                       | 30                | 62.5                              | 55.4                       | 0.830   |

<sup>1</sup> LNA: output full scale = 4.4 V p-p differential.

<sup>2</sup> Filter: loss  $\approx$  1 dB, NBW = 13.3 MHz, GAIN- = 0.8 V.

<sup>3</sup> ADC: 40 MSPS, 70 dB SNR, 2 V p-p full-scale input.

<sup>4</sup> Output dynamic range at minimum VGA gain (VGA dominated).

<sup>5</sup> Output dynamic range at maximum VGA gain (LNA dominated).

<sup>6</sup> Channel noise at maximum VGA gain.

Table 10 demonstrates the sensitivity and dynamic range trade-offs that can be achieved relative to various LNA and VGA gain settings.

For example, when the VGA is set for the minimum gain voltage, the TGC path is dominated by VGA noise and achieves the maximum output SNR. However, as the postamp gain options are increased, the input-referred noise is reduced and the SNR is degraded.

If the VGA is set for the maximum gain voltage, the TGC path is dominated by LNA noise and achieves the lowest input-referred noise, but with degraded output SNR. The higher the TGC (LNA + VGA) gain, the lower the output SNR. As the postamp gain is increased, the input-referred noise is reduced.

At low gains, the VGA should limit the system noise performance (SNR); at high gains, the noise is defined by the source and the LNA. The maximum voltage swing is bound by the full-scale peak-to-peak ADC input voltage (2 V p-p).

Both the LNA and VGA have full-scale limitations within each section of the TGC path. These limitations are dependent on the gain setting of each function block and on the voltage applied to the GAIN+ and GAIN- pins. The LNA has three limitations, or full-scale settings, that can be applied through the SPI.

Similarly, the VGA has four postamp gain settings that can be applied through the SPI. The voltage applied to the GAIN± pins determines which amplifier (the LNA or VGA) saturates first. The maximum signal input level that can be applied as a function of voltage on the GAIN± pins for the selectable gain options of the SPI is shown in Figure 56 to Figure 58.

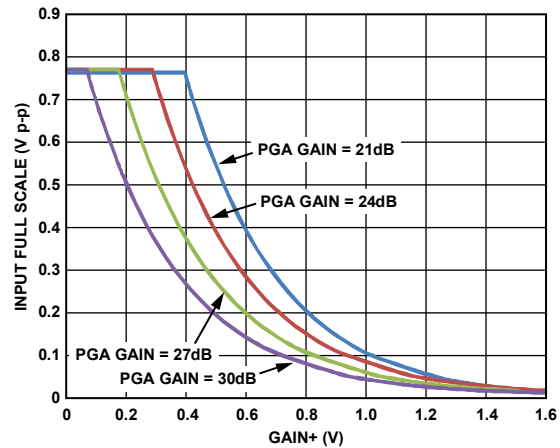

Figure 56. LNA with 15.6 dB Gain Setting/VGA Full-Scale Limitations

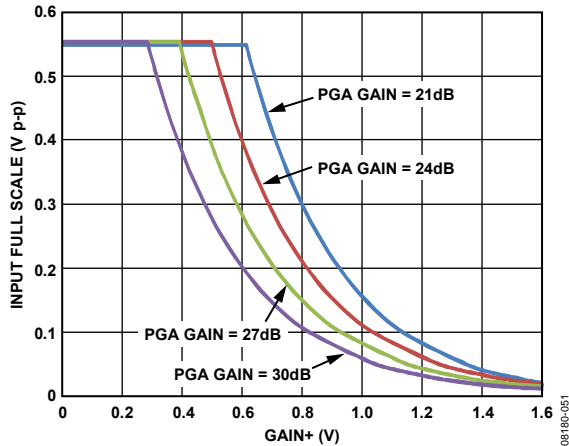

Figure 57. LNA with 17.9 dB Gain Setting/VGA Full-Scale Limitations

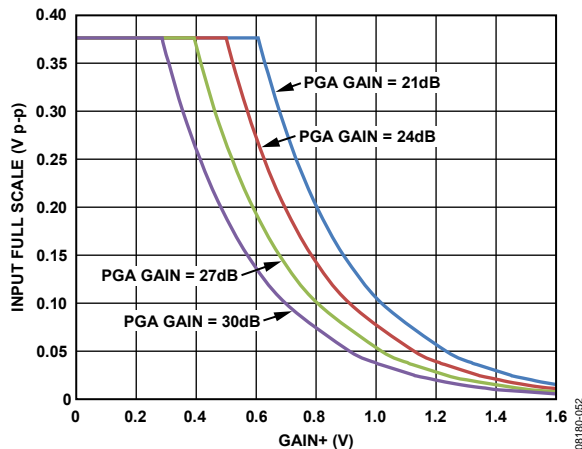

Figure 58. LNA with 21.3 dB Gain Setting/VGA Full-Scale Limitations

**Variable Gain Amplifier (VGA)**

The differential X-AMP VGA provides precise input attenuation and interpolation. It has a low input-referred noise of 3.8 nV/ $\sqrt{\text{Hz}}$  and excellent gain linearity. A simplified block diagram is shown in Figure 59.

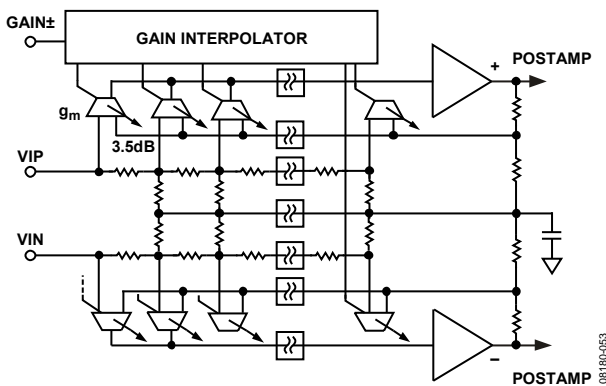

Figure 59. Simplified VGA Schematic

The input of the VGA is a 14-stage differential resistor ladder with 3.5 dB per tap. The resulting total gain range is 42 dB, which allows for range loss at the endpoints. The effective input resistance per side is 180  $\Omega$  nominally for a total differential resistance of 360  $\Omega$ . The ladder is driven by a fully differential input signal from the LNA. LNA outputs are dc-coupled to avoid external decoupling capacitors. The common-mode voltage of the attenuator and the VGA is controlled by an amplifier that uses the same midsupply voltage derived in the LNA, permitting dc coupling of the LNA to the VGA without introducing large offsets due to common-mode differences. However, any offset from the LNA becomes amplified as the gain increases, producing an exponentially increasing VGA output offset.

The input stages of the X-AMP are distributed along the ladder, and a biasing interpolator, controlled by the gain interface, determines the input tap point. With overlapping bias currents, signals from successive taps merge to provide a smooth attenuation range from -42 dB to 0 dB. This circuit technique results in linear-in-dB gain law conformance and low distortion levels—only deviating  $\pm 0.5$  dB or less from the ideal. The gain slope is monotonic with respect to the control voltage and is stable with variations in process, temperature, and supply.

The X-AMP inputs are part of a programmable gain feedback amplifier that completes the VGA. Its bandwidth is approximately 100 MHz. The input stage is designed to reduce feedthrough to the output and to ensure excellent frequency response uniformity across the gain setting.

**Gain Control**

The gain control interface, GAIN $\pm$ , is a differential input. V<sub>GAIN</sub> varies the gain of all VGAs through the interpolator by selecting the appropriate input stages connected to the input attenuator. For GAIN- at 0.8 V, the nominal GAIN+ range for 28.5 dB/V is 0 V to 1.6 V, with the best gain linearity from about 0.16 V to 1.44 V, where the error is typically less than  $\pm 0.5$  dB. For GAIN+ voltages greater than 1.44 V and less than 0.16 V, the error increases. The value of GAIN+ can exceed the supply voltage by 1 V without gain foldover.

Gain control response time is less than 750 ns to settle within 10% of the final value for a change from minimum to maximum gain.

The GAIN+ and GAIN- pins can be interfaced in one of two ways. Using a single-ended method, a Kelvin type of connection to ground can be used, as shown in Figure 60. For driving multiple devices, it is preferable to use a differential method, as shown in Figure 61. In either method, the GAIN+ and GAIN- pins should be dc-coupled and driven to accommodate a 1.6 V full-scale input.

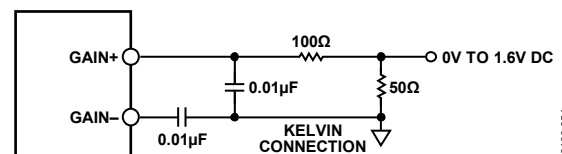

Figure 60. Single-Ended GAIN+, GAIN- Pin Configuration

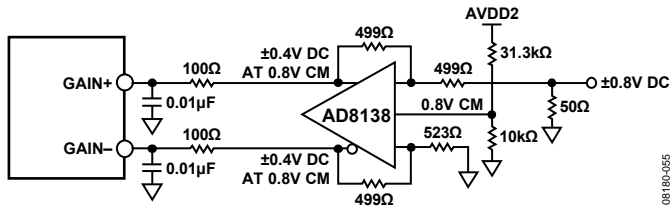

Figure 61. Differential GAIN+, GAIN- Pin Configuration

## VGA Noise

In a typical application, a VGA compresses a wide dynamic range input signal to within the input span of an ADC. The input-referred noise of the LNA limits the minimum resolvable input signal, whereas the output-referred noise, which depends primarily on the VGA, limits the maximum instantaneous dynamic range that can be processed at any one particular gain control voltage. This latter limit is set in accordance with the total noise floor of the ADC.

Output-referred noise as a function of GAIN+ is shown in Figure 11, Figure 12, and Figure 14 for the short-circuit input conditions. The input noise voltage is simply equal to the output noise divided by the measured gain at each point in the control range.

The output-referred noise is a flat 60 nV/√Hz (postamp gain = 24 dB) over most of the gain range because it is dominated by the fixed output-referred noise of the VGA. At the high end of the gain control range, the noise of the LNA and of the source prevails. The input-referred noise reaches its minimum value near the maximum gain control voltage, where the input-referred contribution of the VGA is miniscule.

At lower gains, the input-referred noise and, therefore, the noise figure, increase as the gain decreases. The instantaneous dynamic range of the system is not lost, however, because the input capacity increases as the input-referred noise increases. The contribution of the ADC noise floor has the same dependence. The important relationship is the magnitude of the VGA output noise floor relative to that of the ADC.

Gain control noise is a concern in very low noise applications. Thermal noise in the gain control interface can modulate the channel gain. The resultant noise is proportional to the output signal level and is usually evident only when a large signal is present. The gain interface includes an on-chip noise filter, which significantly reduces this effect at frequencies above 5 MHz. Care should be taken to minimize noise impinging at the GAIN± inputs. An external RC filter can be used to remove V<sub>GAIN</sub> source noise. The filter bandwidth should be sufficient to accommodate the desired control bandwidth.

## Antialiasing Filter (AAF)

The filter that the signal reaches prior to the ADC is used to reject dc signals and to band limit the signal for antialiasing. Figure 62 shows the architecture of the filter.

The antialiasing filter is a combination of a single-pole high-pass filter and a second-order low-pass filter. The high-pass filter can be configured at a ratio of the low-pass filter cutoff. This is selectable through the SPI.

The filter uses on-chip tuning to trim the capacitors and, in turn, to set the desired cutoff frequency and reduce variations. The default -3 dB low-pass filter cutoff is 1/3 or 1/4.5 the ADC sample clock rate. The cutoff can be scaled to 0.7, 0.8, 0.9, 1, 1.1, 1.2, or 1.3 times this frequency through the SPI. The cutoff tolerance is maintained from 8 MHz to 18 MHz.

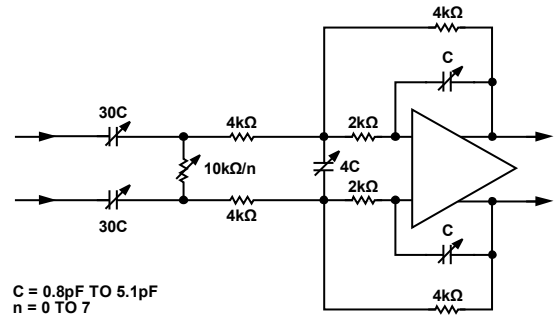

Figure 62. Simplified Antialiasing Filter Schematic

Tuning is normally off to avoid changing the capacitor settings during critical times. The tuning circuit is enabled and disabled through the SPI. Initializing the tuning of the filter must be performed after initial power-up and after reprogramming the filter cutoff scaling or ADC sample rate. Occasional retuning during an idle time is recommended to compensate for temperature drift.

A total of eight SPI-programmable settings allows the user to vary the high-pass filter cutoff frequency as a function of the low-pass cutoff frequency. Two examples are shown in Table 11: one is for an 8 MHz low-pass cutoff frequency, and the other is for an 18 MHz low-pass cutoff frequency. In both cases, as the ratio decreases, the amount of rejection on the low-end frequencies increases. Therefore, making the entire AAF frequency pass band narrow can reduce low frequency noise or maximize dynamic range for harmonic processing.

Table 11. SPI-Selectable High-Pass Filter Cutoff Options

| SPI Setting | Ratio <sup>1</sup> | High-Pass Cutoff Frequency |                          |
|-------------|--------------------|----------------------------|--------------------------|
|             |                    | Low-Pass Cutoff = 8 MHz    | Low-Pass Cutoff = 18 MHz |
| 0           | 20.65              | 387 kHz                    | 872 kHz                  |
| 1           | 11.45              | 698 kHz                    | 1.571 MHz                |
| 2           | 7.92               | 1.010 MHz                  | 2.273 MHz                |
| 3           | 6.04               | 1.323 MHz                  | 2.978 MHz                |
| 4           | 4.88               | 1.638 MHz                  | 3.685 MHz                |
| 5           | 4.10               | 1.953 MHz                  | 4.394 MHz                |
| 6           | 3.52               | 2.270 MHz                  | 5.107 MHz                |
| 7           | 3.09               | 2.587 MHz                  | 5.822 MHz                |

<sup>1</sup> Ratio = low-pass filter cutoff frequency/high-pass filter cutoff frequency.



## ADC

The AD9276 uses a pipelined ADC architecture. The quantized output from each stage is combined into a 12-bit result in the digital correction logic. The pipelined architecture permits the first stage to operate on a new input sample and the remaining stages to operate on preceding samples. Sampling occurs on the rising edge of the clock.

The output staging block aligns the data, corrects errors, and passes the data to the output buffers. The data is then serialized and aligned to the frame and output clocks.

## CLOCK INPUT CONSIDERATIONS

For optimum performance, the AD9276 sample clock inputs (CLK+ and CLK-) should be clocked with a differential signal. This signal is typically ac-coupled into the CLK+ and CLK- pins via a transformer or capacitors. These pins are biased internally and require no additional bias.

Figure 63 shows the preferred method for clocking the AD9276. A low jitter clock source, such as the Valpey Fisher oscillator VFAC3-BHL-50 MHz, is converted from single-ended to differential using an RF transformer. The back-to-back Schottky diodes across the secondary transformer limit clock excursions into the AD9276 to approximately 0.8 V p-p differential. This helps to prevent the large voltage swings of the clock from feeding through to other portions of the AD9276, and it preserves the fast rise and fall times of the signal, which are critical to low jitter performance.

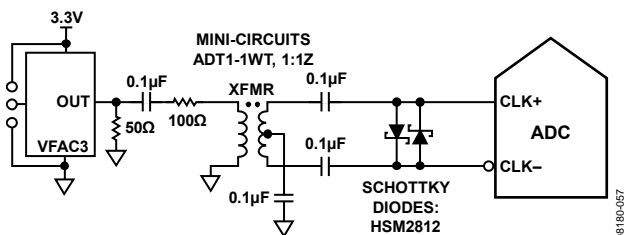
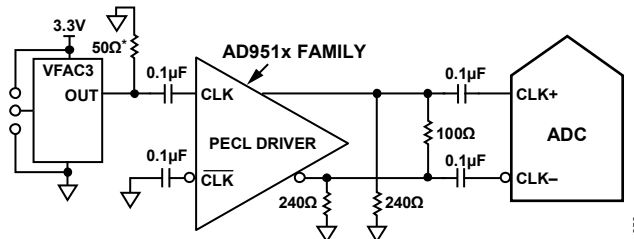

Figure 63. Transformer-Coupled Differential Clock

If a low jitter clock is available, another option is to ac-couple a differential PECL signal to the sample clock input pins, as shown in Figure 64. The AD951x family of clock drivers offers excellent jitter performance.



\*50Ω RESISTOR IS OPTIONAL.

Figure 64. Differential PECL Sample Clock

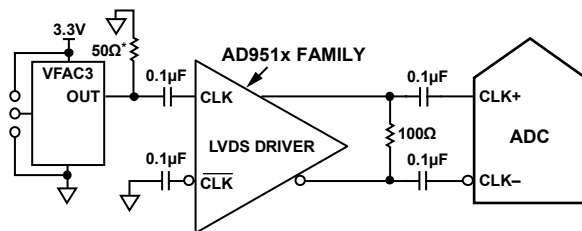

\*50Ω RESISTOR IS OPTIONAL.

Figure 65. Differential LVDS Sample Clock

In some applications, it is acceptable to drive the sample clock inputs with a single-ended CMOS signal. In such applications, CLK+ should be driven directly from a CMOS gate, and the CLK- pin should be bypassed to ground with a 0.1 μF capacitor in parallel with a 39 kΩ resistor (see Figure 66). Although the CLK+ input circuit supply is AVDD1 (1.8 V), this input is designed to withstand input voltages of up to 3.3 V, making the selection of the drive logic voltage very flexible.

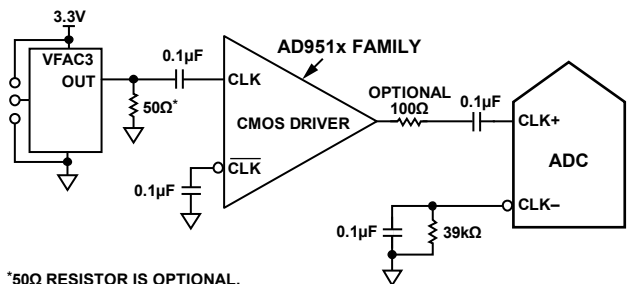

\*50Ω RESISTOR IS OPTIONAL.

Figure 66. Single-Ended 1.8 V CMOS Sample Clock

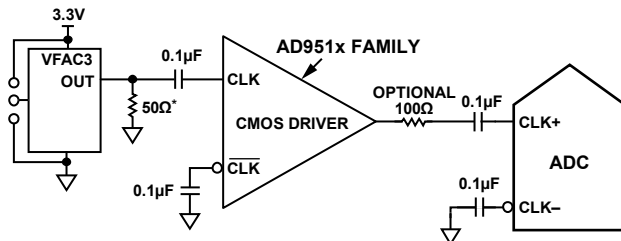

\*50Ω RESISTOR IS OPTIONAL.

Figure 67. Single-Ended 3.3 V CMOS Sample Clock

## Clock Duty Cycle Considerations

Typical high speed ADCs use both clock edges to generate a variety of internal timing signals. As a result, these ADCs may be sensitive to the clock duty cycle. Commonly, a 5% tolerance is required on the clock duty cycle to maintain dynamic performance characteristics. The AD9276 contains a duty cycle stabilizer (DCS) that retimes the nonsampling edge, providing an internal clock signal with a nominal 50% duty cycle. This allows a wide range of clock input duty cycles without affecting the performance of the AD9276. When the DCS is on, noise and distortion performance are nearly flat for a wide range of duty cycles. However, some applications may require the DCS function to be off. If so, keep in mind that the dynamic range performance can be affected when operated in this mode. See Table 18 for more details on using this feature.

The duty cycle stabilizer uses a delay-locked loop (DLL) to create the nonsampling edge. As a result, any changes to the sampling frequency require approximately eight clock cycles to allow the DLL to acquire and lock to the new rate.

### Clock Jitter Considerations

High speed, high resolution ADCs are sensitive to the quality of the clock input. The degradation in SNR at a given input frequency ( $f_A$ ) due only to aperture jitter ( $t_j$ ) can be calculated as follows:

$$\text{SNR Degradation} = 20 \times \log_{10}(1/2 \times \pi \times f_A \times t_j)$$

In this equation, the rms aperture jitter represents the root mean square of all jitter sources, including the clock input, analog input signal, and ADC aperture jitter. IF undersampling applications are particularly sensitive to jitter (see Figure 68).

The clock input should be treated as an analog signal in cases where aperture jitter may affect the dynamic range of the AD9276. Power supplies for clock drivers should be separated from the ADC output driver supplies to avoid modulating the clock signal with digital noise. Low jitter, crystal-controlled oscillators make the best clock sources, such as the Valpey Fisher VFAC3 series. If the clock is generated from another type of source (by gating, dividing, or other methods), it should be retimed by the original clock during the last step.

Refer to the AN-501 Application Note and the AN-756 Application Note for more in-depth information about how jitter performance relates to ADCs (visit [www.analog.com](http://www.analog.com)).

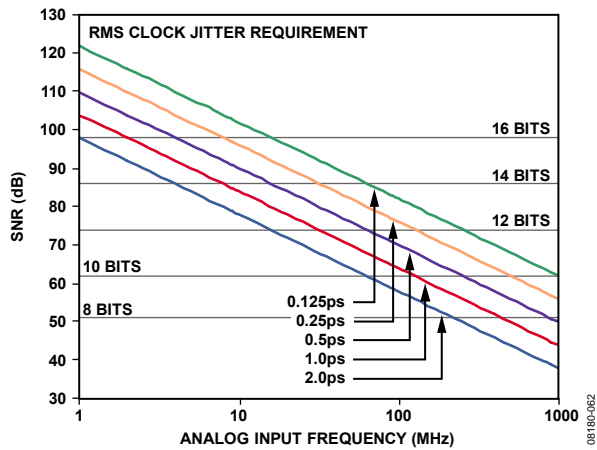

Figure 68. Ideal SNR vs. Input Frequency and Jitter

### Power Dissipation and Power-Down Mode

As shown in Figure 69 and Figure 70, the power dissipated by the AD9276 is proportional to its sample rate. The digital power dissipation does not vary significantly because it is determined primarily by the DRVDD supply and the bias current of the LVDS output drivers.

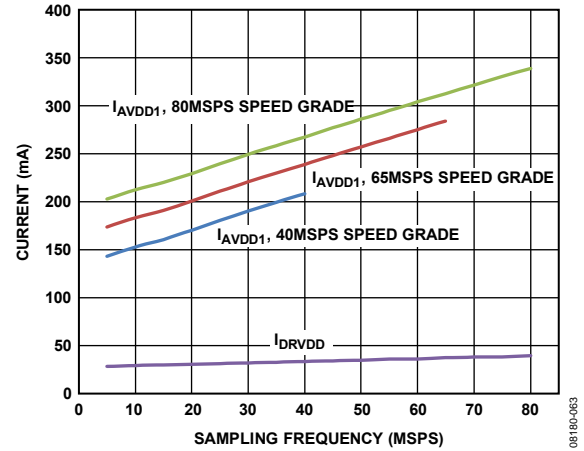

Figure 69. Supply Current vs.  $f_{\text{SAMPLE}}$  for  $f_{\text{IN}} = 5 \text{ MHz}$

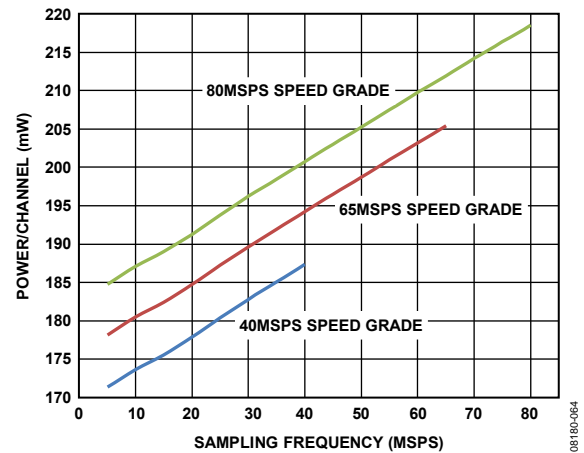

Figure 70. Power per Channel vs.  $f_{\text{SAMPLE}}$  for  $f_{\text{IN}} = 5 \text{ MHz}$

The AD9276 features scalable LNA bias currents (see Table 18, Register 0x12). The default LNA bias current settings are high. Figure 71 shows the typical reduction of AVDD2 current with each bias setting. It is also recommended that the LNA offset be adjusted using Register 0x10 (see Table 18) when the LNA bias setting is low.

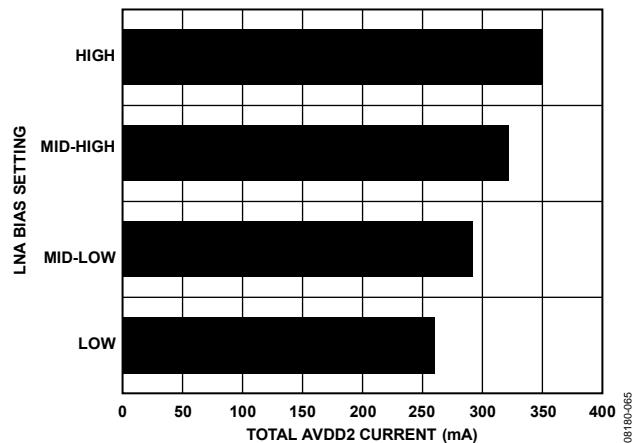

Figure 71. AVDD2 Current at Different LNA Bias Settings,  $f_{\text{SAMPLE}} = 40 \text{ MSPS}$

By asserting the PDWN pin high, the AD9276 is placed into power-down mode. In this state, the device typically dissipates 5 mW. During power-down, the LVDS output drivers are placed into a high impedance state. The AD9276 returns to normal operating mode when the PDWN pin is pulled low. This pin is both 1.8 V and 3.3 V tolerant.

By asserting the STBY pin high, the AD9276 is placed into a standby mode. In this state, the device typically dissipates 175 mW. During standby, the entire part is powered down except for the internal references. The LVDS output drivers are placed into a high impedance state. This mode is well suited for applications that require power savings because it allows the device to be powered down when not in use and then quickly powered up. The time to power the device back up is also greatly reduced. The AD9276 returns to normal operating mode when the STBY pin is pulled low. This pin is both 1.8 V and 3.3 V tolerant.

In power-down mode, low power dissipation is achieved by shutting down the reference, reference buffer, PLL, and biasing networks. The decoupling capacitors on VREF are discharged when entering power-down mode and must be recharged when returning to normal operation. As a result, the wake-up time is related to the time spent in the power-down mode: shorter cycles result in proportionally shorter wake-up times. To restore the device to full operation, approximately 0.5 ms is required when using the recommended 1  $\mu$ F and 0.1  $\mu$ F decoupling capacitors on the VREF pin and the 0.01  $\mu$ F decoupling capacitors on the GAIN $\pm$  pins. Most of this time is dependent on the gain decoupling: higher value decoupling capacitors on the GAIN $\pm$  pins result in longer wake-up times.

A number of other power-down options are available when using the SPI port interface. The user can individually power down each channel or put the entire device into standby mode. This allows the user to keep the internal PLL powered up when fast wake-up times are required. The wake-up time is slightly dependent on gain. To achieve a 1  $\mu$ s wake-up time when the device is in standby mode, 0.8 V must be applied to the GAIN $\pm$  pins. See Table 18 for more details on using these features.

## DIGITAL OUTPUTS AND TIMING

The AD9276 differential outputs conform to the ANSI-644 LVDS standard on default power-up. This can be changed to a low power, reduced signal option similar to the IEEE 1596.3 standard via the SPI, using Register 0x14, Bit 6. This LVDS standard can further reduce the overall power dissipation of the device by approximately 36 mW.

The LVDS driver current is derived on chip and sets the output current at each output equal to a nominal 3.5 mA. A 100  $\Omega$  differential termination resistor placed at the LVDS receiver inputs results in a nominal 350 mV swing at the receiver.

The AD9276 LVDS outputs facilitate interfacing with LVDS receivers in custom ASICs and FPGAs that have LVDS capability for superior switching performance in noisy environments. Single point-to-point network topologies are recommended with a 100  $\Omega$  termination resistor placed as close to the receiver as possible. No far-end receiver termination and poor differential trace routing may result in timing errors. It is recommended that the trace length be no longer than 24 inches and that the differential output traces be kept close together and at equal lengths. An example of the FCO, DCO, and data stream with proper trace length and position is shown in Figure 72.

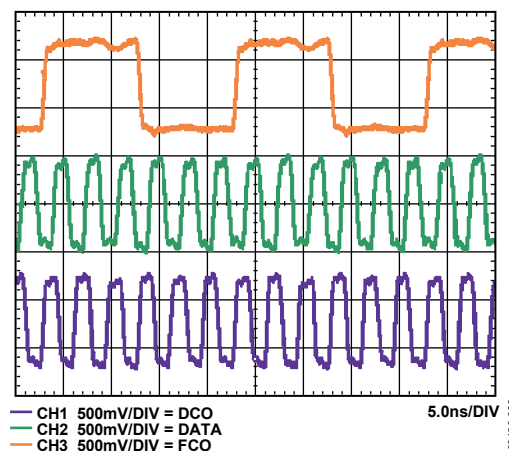

Figure 72. LVDS Output Timing Example in ANSI-644 Mode (Default)

An example of the LVDS output using the ANSI-644 standard (default) data eye and a time interval error (TIE) jitter histogram with trace lengths less than 24 inches on regular FR-4 material is shown in Figure 73. Figure 74 shows an example of the trace lengths exceeding 24 inches on regular FR-4 material. Notice that the TIE jitter histogram reflects the decrease of the data eye opening as the edge deviates from the ideal position; therefore, the user must determine whether the waveforms meet the timing budget of the design when the trace lengths exceed 24 inches.

Additional SPI options allow the user to further increase the internal termination (and therefore increase the current) of all eight outputs in order to drive longer trace lengths (see Figure 75). Even though this produces sharper rise and fall times on the data edges, is less prone to bit errors, and improves frequency distribution (see Figure 75), the power dissipation of the DRVDD supply increases when this option is used.

In cases that require increased driver strength to the DCO $\pm$  and FCO $\pm$  outputs because of load mismatch, the user can double the drive strength by setting Bit 0 in Register 0x15. Note that this feature cannot be used with Bits[5:4] in Register 0x15 because these bits take precedence over this feature. See Table 18 for more details.

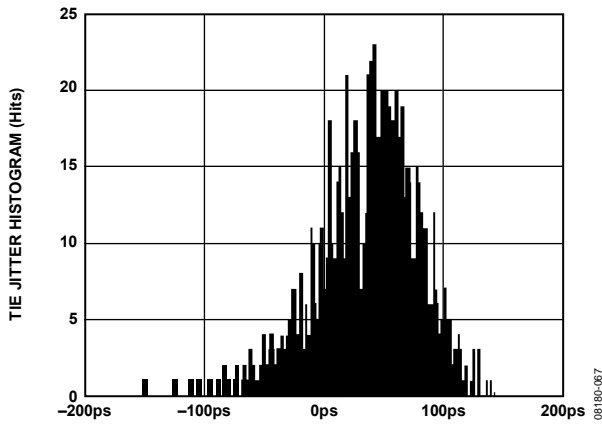
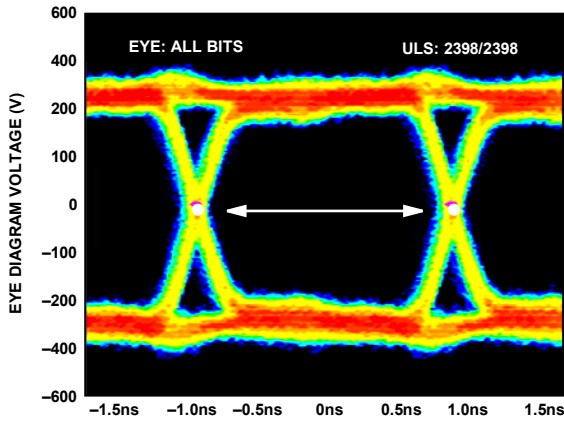

Figure 73. Data Eye for LVDS Outputs in ANSI-644 Mode with Trace Lengths of Less Than 24 Inches on Standard FR-4

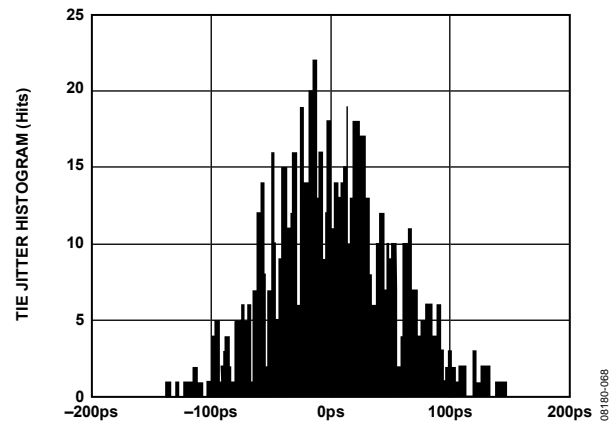
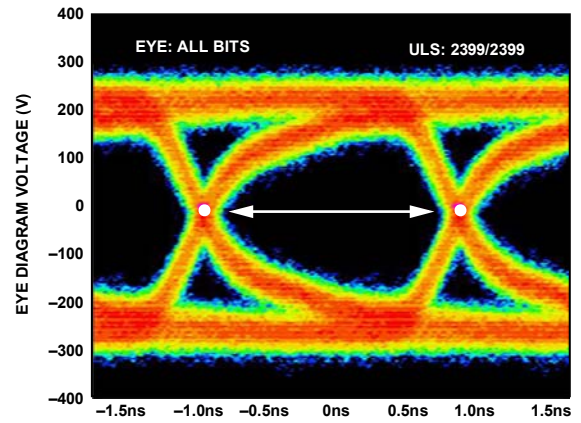

Figure 74. Data Eye for LVDS Outputs in ANSI-644 Mode with Trace Lengths of Greater Than 24 Inches on Standard FR-4

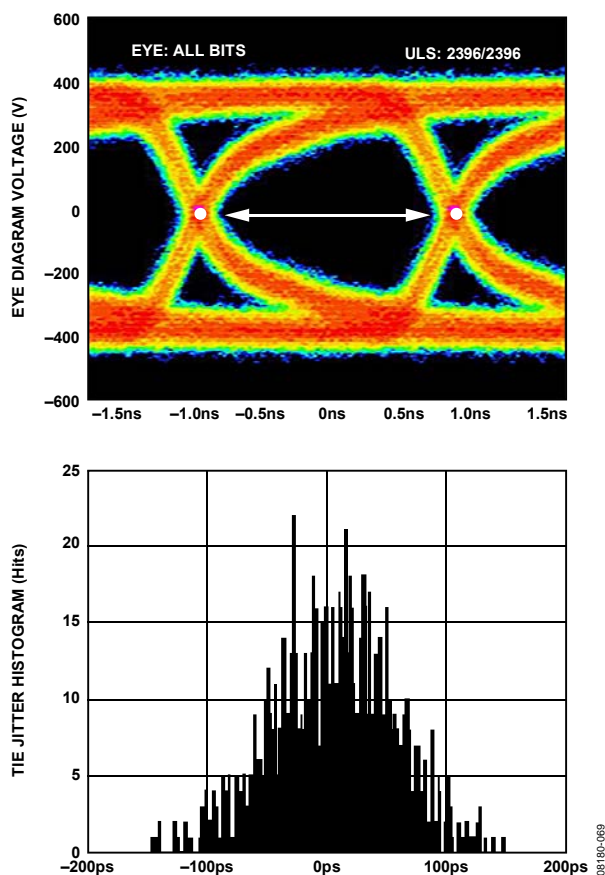

Figure 75. Data Eye for LVDS Outputs in ANSI-644 Mode with 100  $\Omega$  Termination On and Trace Lengths of Greater Than 24 Inches on Standard FR-4

The format of the output data is offset binary by default. Table 12 provides an example of the output coding format. To change the output data format to twos complement, see the Memory Map section.

Table 12. Digital Output Coding

| Code | ( $V_{IN+}$ ) – ( $V_{IN-}$ ),<br>Input Span = 2 V p-p (V) | Digital Output<br>Offset Binary (D11 to D0) |
|------|--|---|
| 4095 | +1.00  | 1111 1111 1111                              |
| 2048 | 0.00   | 1000 0000 0000                              |
| 2047 | -0.000488  | 0111 1111 1111                              |
| 0    | -1.00  | 0000 0000 0000                              |

Data from each ADC is serialized and provided on a separate channel. The data rate for each serial stream is equal to 12 bits times the sample clock rate, with a maximum of 960 Mbps (12 bits  $\times$  80 MSPS = 960 Mbps). The lowest typical conversion rate is 10 MSPS, but the PLL can be set up for encode rates as low as 5 MSPS via the SPI if lower sample rates are required for a specific application. See Table 18 for details on enabling this feature.

Two output clocks are provided to assist in capturing data from the AD9276. DCO $\pm$  is used to clock the output data and is equal to six times the sampling clock rate. Data is clocked out of the AD9276 and must be captured on the rising and falling edges of DCO $\pm$ , which supports double data rate (DDR) capturing. The frame clock output (FCO $\pm$ ) is used to signal the start of a new output byte and is equal to the sampling clock rate. See the timing diagram shown in Figure 2 for more information.

When using the serial port interface (SPI), the DCO $\pm$  phase can be adjusted in 60 $^\circ$  increments relative to the data edge. This enables the user to refine system timing margins if required. The default DCO $\pm$  timing, as shown in Figure 2, is 180 $^\circ$  relative to the output data edge.

An 8-, 10-, or 14-bit serial stream can also be initiated from the SPI. This allows the user to implement different serial streams and to test the device's compatibility with lower and higher resolution systems. When changing the resolution to an 8- or 10-bit serial stream, the data stream is shortened. When using the 14-bit option, the data stream stuffs two 0s at the end of the normal 12-bit serial data.

When using the SPI, all of the data outputs can also be inverted from their nominal state by setting Bit 2 in the output mode register (Address 0x14). This is not to be confused with inverting the serial stream to an LSB first mode. In default mode, as shown in Figure 2, the MSB is represented first in the data output serial stream. However, this order can be inverted so that the LSB is represented first in the data output serial stream (see Figure 3).

There are 12 digital output test pattern options available that can be initiated through the SPI. This feature is useful when validating receiver capture and timing. Refer to Table 13 for the output bit sequencing options available. Some test patterns have two serial sequential words and can be alternated in various ways, depending on the test pattern chosen. Note that some patterns may not adhere to the data format select option. In addition, custom user-defined test patterns can be assigned in the user pattern registers (Address 0x19 through Address 0x1C). All test mode options except PN sequence short and PN sequence long can support 8- to 14-bit word lengths in order to verify data capture to the receiver.

The PN sequence short pattern produces a pseudorandom bit sequence that repeats itself every  $2^9 - 1$  bits, or 511 bits. A description of the PN sequence short and how it is generated can be found in Section 5.1 of the ITU-T O.150 (05/96) standard. The only difference is that the starting value is a specific value instead of all 1s (see Table 14 for the initial values).

**Table 13. Flexible Output Test Modes**

| Output Test Mode Bit Sequence | Pattern Name          | Digital Output Word 1           | Digital Output Word 2           | Subject to Data Format Select |
|-------------------------------|-----------------------|---------------------------------|---------------------------------|-------------------------------|
| 0000                          | Off (default)         | N/A                             | N/A                             | N/A                           |
| 0001                          | Midscale short        | 1000 0000 0000                  | Same                            | Yes                           |
| 0010                          | +Full-scale short     | 1111 1111 1111                  | Same                            | Yes                           |
| 0011                          | –Full-scale short     | 0000 0000 0000                  | Same                            | Yes                           |
| 0100                          | Checkerboard          | 1010 1010 1010                  | 0101 0101 0101                  | No                            |
| 0101                          | PN sequence long      | N/A                             | N/A                             | Yes                           |
| 0110                          | PN sequence short     | N/A                             | N/A                             | Yes                           |
| 0111                          | One-/zero-word toggle | 1111 1111 1111                  | 0000 0000 0000                  | No                            |
| 1000                          | User input            | Register 0x19 and Register 0x1A | Register 0x1B and Register 0x1C | No                            |
| 1001                          | 1-/0-bit toggle       | 1010 1010 1010                  | N/A                             | No                            |
| 1010                          | 1× sync               | 0000 0011 1111                  | N/A                             | No                            |
| 1011                          | One bit high          | 1000 0000 0000                  | N/A                             | No                            |
| 1100                          | Mixed bit frequency   | 1010 0011 0011                  | N/A                             | No                            |

The PN sequence long pattern produces a pseudorandom bit sequence that repeats itself every  $2^{23} - 1$  bits, or 8,388,607 bits. A description of the PN sequence long and how it is generated can be found in Section 5.6 of the ITU-T O.150 (05/96) standard. The only differences are that the starting value is a specific value instead of all 1s and that the AD9276 inverts the bit stream with relation to the ITU-T standard (see Table 14 for the initial values).

**Table 14. PN Sequence**

| Sequence          | Initial Value | First Three Output Samples (MSB First) |
|-------------------|---------------|--|
| PN Sequence Short | 0x0DF         | 0xDF9, 0x353, 0x301                    |
| PN Sequence Long  | 0x29B80A      | 0x591, 0xFD7, 0x0A3                    |

See the Memory Map section for information on how to change these additional digital output timing features through the SPI.

### SDIO Pin

This pin is required to operate the SPI. It has an internal 30 kΩ pull-down resistor that pulls this pin low and is only 1.8 V tolerant. If applications require that this pin be driven from a 3.3 V logic level, insert a 1 kΩ resistor in series with this pin to limit the current.

### SCLK Pin

This pin is required to operate the SPI port interface. It has an internal 30 kΩ pull-down resistor that pulls this pin low and is both 1.8 V and 3.3 V tolerant.

### CSB Pin

This pin is required to operate the SPI port interface. It has an internal 70 kΩ pull-up resistor that pulls this pin high and is both 1.8 V and 3.3 V tolerant.

### RBIAS Pin

To set the internal core bias current of the ADC, place a resistor nominally equal to 10.0 kΩ to ground at the RBIAS pin. Using a resistor other than the recommended 10.0 kΩ resistor for RBIAS degrades the performance of the device. Therefore, it is imperative that at least a 1% tolerance on this resistor be used to achieve consistent performance.

### Voltage Reference

A stable and accurate 0.5 V voltage reference is built into the AD9276. This is gained up internally by a factor of 2, setting VREF to 1.0 V, which results in a full-scale differential input span of 2.0 V p-p for the ADC. VREF is set internally by default, but the VREF pin can be driven externally with a 1.0 V reference to achieve more accuracy. However, the AD9276 does not support ADC full-scale ranges below 2.0 V p-p.

When applying the decoupling capacitors to the VREF pin, use ceramic, low ESR capacitors. These capacitors should be close to the reference pin and on the same layer of the PCB as the AD9276. The VREF pin should have both a 0.1 μF capacitor and a 1 μF capacitor connected in parallel to the analog ground. These capacitor values are recommended for the ADC to properly settle and acquire the next valid sample.

The reference settings can be selected using the SPI. The settings allow two options: using the internal reference or using an external reference. The internal reference option is the default setting and has a resulting differential span of 2 V p-p.

**Table 15. SPI-Selectable Reference Settings**

| SPI-Selected Mode            | Resulting VREF (V) | Resulting Differential Span (V p-p) |
|------------------------------|--------------------|-------------------------------------|
| External Reference           | N/A                | 2 × external reference              |
| Internal Reference (Default) | 1.0                | 2.0                                 |

## SERIAL PORT INTERFACE (SPI)

The AD9276 serial port interface allows the user to configure the signal chain for specific functions or operations through a structured register space provided inside the chip. The SPI offers the user added flexibility and customization, depending on the application. Addresses are accessed via the serial port and can be written to or read from via the port. Memory is organized into bytes that can be further divided into fields, as documented in the Memory Map section. Detailed operational information can be found in the Analog Devices, Inc., AN-877 Application Note, *Interfacing to High Speed ADCs via SPI*.

Three pins define the serial port interface, or SPI: SCLK, SDIO, and CSB (see Table 16). The SCLK (serial clock) pin is used to synchronize the read and write data presented to the device. The SDIO (serial data input/output) pin is a dual-purpose pin that allows data to be sent to and read from the internal memory map registers of the device. The CSB (chip select bar) pin is an active low control that enables or disables the read and write cycles.

**Table 16. Serial Port Pins**

| Pin  | Function  |
|------|---|
| SCLK | Serial clock. Serial shift clock input. SCLK is used to synchronize serial interface reads and writes.  |
| SDIO | Serial data input/output. Dual-purpose pin that typically serves as an input or an output, depending on the instruction sent and the relative position in the timing frame. |
| CSB  | Chip select bar (active low). This control gates the read and write cycles.   |

The falling edge of CSB in conjunction with the rising edge of SCLK determines the start of the framing sequence. During an instruction phase, a 16-bit instruction is transmitted, followed by one or more data bytes, which is determined by Bit Field W0 and Bit Field W1. An example of the serial timing and its definitions can be found in Figure 76 and Table 17.

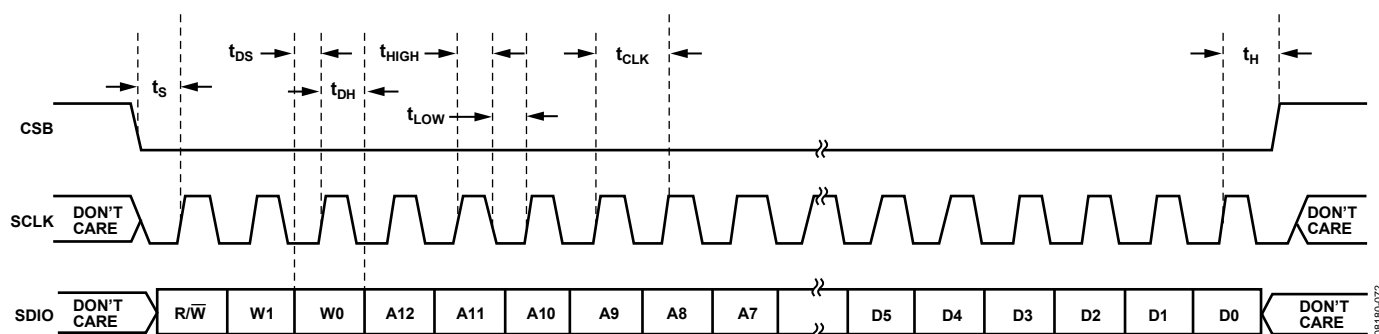

Figure 76. Serial Timing Details

**Table 17. Serial Timing Definitions**

| Parameter       | Timing (ns min) | Description   |
|-----------------|-----------------|---|
| $t_{DS}$        | 5               | Setup time between the data and the rising edge of SCLK   |
| $t_{DH}$        | 2               | Hold time between the data and the rising edge of SCLK  |
| $t_{CLK}$       | 40              | Period of the clock   |
| $t_s$           | 5               | Setup time between CSB and SCLK   |
| $t_H$           | 2               | Hold time between CSB and SCLK  |
| $t_{HIGH}$      | 16              | Minimum period that SCLK should be in a logic high state  |
| $t_{LOW}$       | 16              | Minimum period that SCLK should be in a logic low state   |
| $t_{EN\_SDIO}$  | 10              | Minimum time for the SDIO pin to switch from an input to an output relative to the SCLK falling edge (not shown in Figure 76) |
| $t_{DIS\_SDIO}$ | 10              | Minimum time for the SDIO pin to switch from an output to an input relative to the SCLK rising edge (not shown in Figure 76)  |

During normal operation, CSB is used to signal to the device that SPI commands are to be received and processed. When CSB is brought low, the device processes SCLK and SDIO to execute instructions. Normally, CSB remains low until the communication cycle is complete. However, if connected to a slow device, CSB can be brought high between bytes, allowing older microcontrollers enough time to transfer data into shift registers. CSB can be stalled when transferring one, two, or three bytes of data. When W0 and W1 are set to 11, the device enters streaming mode and continues to process data, either reading or writing, until CSB is taken high to end the communication cycle. This allows complete memory transfers without the need for additional instructions. Regardless of the mode, if CSB is taken high in the middle of a byte transfer, the SPI state machine is reset and the device waits for a new instruction.

In addition to the operation modes, the SPI port can be configured to operate in different manners. For applications that do not require a control port, the CSB line can be tied and held high. This places the remainder of the SPI pins in their secondary mode (see the AN-877 Application Note). CSB can also be tied low to enable 2-wire mode. When CSB is tied low, SCLK and SDIO are the only pins required for communication. Although the device is synchronized during power-up, caution must be exercised when using 2-wire mode to ensure that the serial port remains synchronized with the CSB line. When operating in 2-wire mode, it is recommended that a 1-, 2-, or 3-byte transfer be used exclusively. Without an active CSB line, streaming mode can be entered but not exited.

In addition to word length, the instruction phase determines whether the serial frame is a read or write operation, allowing the serial port to be used to both program the chip and to read the contents of the on-chip memory. If the instruction is a read-back operation, performing a readback causes the serial data input/output (SDIO) pin to change direction from an input to an output at the appropriate point in the serial frame.

Data can be sent in MSB first mode or LSB first mode. MSB first mode is the default at power-up and can be changed by adjusting the configuration register. For more information about this and other features, see the AN-877 Application Note, *Interfacing to High Speed ADCs via SPI*.

## HARDWARE INTERFACE

The pins described in Table 16 constitute the physical interface between the user's programming device and the serial port of the AD9276. The SCLK and CSB pins function as inputs when using the SPI. The SDIO pin is bidirectional, functioning as an input during write phases and as an output during readback.

If multiple SDIO pins share a common connection, ensure that proper  $V_{OH}$  levels are met. Figure 77 shows the number of SDIO pins that can be connected together and the resulting  $V_{OH}$  level, assuming the same load for each AD9276.

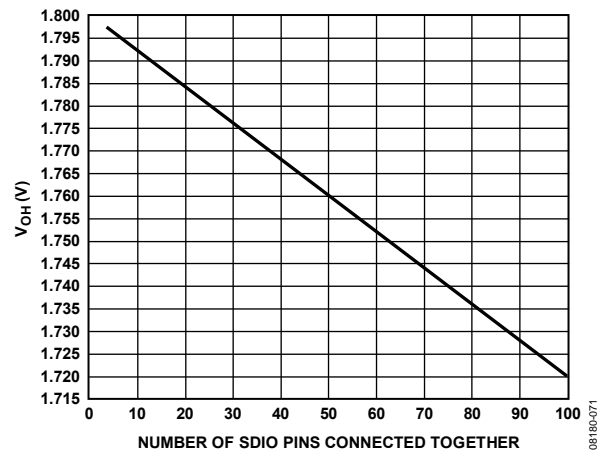

Figure 77. SDIO Pin Loading

This interface is flexible enough to be controlled by either serial PROMs or PIC microcontrollers, providing the user with an alternative method, other than a full SPI controller, for programming the device (see the AN-812 Application Note).



## MEMORY MAP

### READING THE MEMORY MAP TABLE

Each row in the memory map register table has eight bit locations. The memory map is roughly divided into three sections: the chip configuration register map (Address 0x00 to Address 0x02), the device index and transfer register map (Address 0x04 to Address 0xFF), and the program register map (Address 0x08 to Address 0x2D).

The leftmost column of the memory map indicates the register address, and the default value is shown in the second rightmost column. The Bit 7 (MSB) column is the start of the default hexadecimal value given. For example, Address 0x09, the clock register, has a default value of 0x01, meaning that Bit 7 = 0, Bit 6 = 0, Bit 5 = 0, Bit 4 = 0, Bit 3 = 0, Bit 2 = 0, Bit 1 = 0, and Bit 0 = 1, or 0000 0001 in binary. This setting is the default for the duty cycle stabilizer in the on condition. By writing a 0 to Bit 0 of this address, followed by 0x01 in Register 0xFF (the transfer bit), the duty cycle stabilizer is turned off. It is important to follow each writing sequence with a transfer bit to update the SPI registers.

All registers except Register 0x00, Register 0x02, Register 0x04, Register 0x05, and Register 0xFF are buffered with a master slave latch and require writing to the transfer bit. For more information on this and other functions, consult the AN-877 Application Note, *Interfacing to High Speed ADCs via SPI*.

### RESERVED LOCATIONS

Undefined memory locations should not be written to except when writing the default values suggested in this data sheet. Addresses that have values marked as 0 should be considered reserved and have a 0 written into their registers during power-up.

### DEFAULT VALUES

After a reset, critical registers are automatically loaded with default values. These values are indicated in Table 18, where an X refers to an undefined feature.

### LOGIC LEVELS

An explanation of various registers follows: “bit is set” is synonymous with “bit is set to Logic 1” or “writing Logic 1 for the bit.” Similarly, “bit is cleared” is synonymous with “bit is set to Logic 0” or “writing Logic 0 for the bit.”

# AD9276

Table 18. AD9276 Memory Map Registers

| Addr. (Hex)                                | Register Name    | Bit 7 (MSB)  | Bit 6                                       | Bit 5  | Bit 4   | Bit 3  | Bit 2   | Bit 1  | Bit 0 (LSB)                                      | Default Value | Comments  |   |
|--|------------------|--|---|--|---|--|---|--|--|---------------|---|---|
| <b>Chip Configuration Registers</b>        |                  |  |   |  |   |  |   |  |  |               |   |   |
| 0x00                                       | chip_port_config | 0  | LSB first<br>1 = on<br>0 = off<br>(default) | Soft reset<br>1 = on<br>0 = off<br>(default)   | 1   | 1  | Soft reset<br>1 = on<br>0 = off<br>(default)  | LSB first<br>1 = on<br>0 = off<br>(default)      | 0  | 0x18          | Nibbles should be mirrored so that LSB or MSB first mode is set correctly regardless of shift mode.                             |   |
| 0x01                                       | chip_id          | Chip ID Bits[7:0]<br>(AD9276 = 0x72, default)  |   |  |   |  |   |  |  |               |   | Default is unique chip ID, different for each device. Read-only register. |
| 0x02                                       | chip_grade       | X  | X   | Child ID[5:4]<br>(identify device variants of chip ID)<br>00: Mode I<br>(40 MSPS) (default)<br>01: Mode II (65 MSPS)<br>10: Mode III (80 MSPS) |   | X  | X   | X  | X  | 0x00          | Child ID used to differentiate ADC speed power modes.   |   |
| <b>Device Index and Transfer Registers</b> |                  |  |   |  |   |  |   |  |  |               |   |   |
| 0x04                                       | device_index_2   | X  | X   | X  | X   | Data Channel H<br>1 = on<br>(default)<br>0 = off   | Data Channel G<br>1 = on<br>(default)<br>0 = off  | Data Channel F<br>1 = on<br>(default)<br>0 = off | Data Channel E<br>1 = on<br>(default)<br>0 = off | 0x0F          | Bits are set to determine which on-chip device receives the next write command.   |   |
| 0x05                                       | device_index_1   | X  | X   | Clock Channel DCO±<br>1 = on<br>0 = off<br>(default)   | Clock Channel FCO±<br>1 = on<br>0 = off<br>(default)      | Data Channel D<br>1 = on<br>(default)<br>0 = off   | Data Channel C<br>1 = on<br>(default)<br>0 = off  | Data Channel B<br>1 = on<br>(default)<br>0 = off | Data Channel A<br>1 = on<br>(default)<br>0 = off | 0x0F          | Bits are set to determine which on-chip device receives the next write command.   |   |
| 0xFF                                       | device_update    | X  | X   | X  | X   | X  | X   | X  | SW transfer<br>1 = on<br>0 = off<br>(default)    | 0x00          | Synchronously transfers data from the master shift register to the slave.   |   |
| <b>Program Function Registers</b>          |                  |  |   |  |   |  |   |  |  |               |   |   |
| 0x08                                       | modes            | X  | X   | X  | LNA input impedance<br>1 = 5 kΩ<br>0 = 15 kΩ<br>(default) | 0  | Internal power-down mode<br>000 = chip run (default)<br>001 = full power-down<br>010 = standby<br>011 = reset<br>100 = CW mode (TGC PDWN) |  |  | 0x00          | Determines generic modes of chip operation (global).  |   |
| 0x09                                       | clock            | X  | X   | X  | X   | X  | X   | X  | DCS<br>1 = on<br>(default)<br>0 = off            | 0x01          | Turns the internal duty cycle stabilizer (DCS) on and off (global).   |   |
| 0x0D                                       | test_io          | User test mode<br>00 = off (default)<br>01 = on, single alternate<br>10 = on, single once<br>11 = on, alternate once |   | Reset PN long gen<br>1 = on<br>0 = off<br>(default)  | Reset PN short gen<br>1 = on<br>0 = off<br>(default)      | Output test mode—see Table 13<br>0000 = off (default)<br>0001 = midscale short<br>0010 = +FS short<br>0011 = -FS short<br>0100 = checkerboard output<br>0101 = PN sequence long<br>0110 = PN sequence short<br>0111 = one-/zero-word toggle<br>1000 = user input<br>1001 = 1-/0-bit toggle<br>1010 = 1× sync<br>1011 = one bit high<br>1100 = mixed bit frequency (format determined by output_mode) |   |  |  | 0x00          | When this register is set, the test data is placed on the output pins in place of normal data. (Local, except for PN sequence.) |   |
| 0x0E                                       | GPO outputs      | X  | X   | X  | X   | General-purpose digital outputs  |   |  |  | 0x00          | Values placed on GPO[0:3] pins (global).  |   |

| Addr. (Hex) | Register Name      | Bit 7 (MSB)   | Bit 6  | Bit 5   | Bit 4 | Bit 3   | Bit 2   | Bit 1  | Bit 0 (LSB)   | Default Value | Comments   |
|-------------|--------------------|---|--|---|-------|---|---|--|---|---------------|--|
| 0x0F        | flex_channel_input | Filter cutoff frequency control<br>0000 = $1.3 \times 1/3 \times f_{\text{SAMPLE}}$<br>0001 = $1.2 \times 1/3 \times f_{\text{SAMPLE}}$<br>0010 = $1.1 \times 1/3 \times f_{\text{SAMPLE}}$<br>0011 = $1.0 \times 1/3 \times f_{\text{SAMPLE}}$ (default)<br>0100 = $0.9 \times 1/3 \times f_{\text{SAMPLE}}$<br>0101 = $0.8 \times 1/3 \times f_{\text{SAMPLE}}$<br>0110 = $0.7 \times 1/3 \times f_{\text{SAMPLE}}$<br>1000 = $1.3 \times 1/4.5 \times f_{\text{SAMPLE}}$<br>1001 = $1.2 \times 1/4.5 \times f_{\text{SAMPLE}}$<br>1010 = $1.1 \times 1/4.5 \times f_{\text{SAMPLE}}$<br>1011 = $1.0 \times 1/4.5 \times f_{\text{SAMPLE}}$<br>1100 = $0.9 \times 1/4.5 \times f_{\text{SAMPLE}}$<br>1101 = $0.8 \times 1/4.5 \times f_{\text{SAMPLE}}$<br>1110 = $0.7 \times 1/4.5 \times f_{\text{SAMPLE}}$ |  |   |       | X   | X   | X  | X   | 0x30          | Antialiasing filter cutoff (global).   |
| 0x10        | flex_offset        | X   | X  | 6-bit LNA offset adjustment<br>10 0000 for LNA bias high, mid-high, mid-low (default)<br>10 0001 for LNA bias low |       |   |   | 0x20   | LNA force offset correction (local).  |               |  |
| 0x11        | flex_gain          | X   | X  | X   | X     | PGA gain<br>00 = 21 dB<br>01 = 24 dB (default)<br>10 = 27 dB<br>11 = 30 dB  |   | LNA gain<br>00 = 15.6 dB<br>01 = 17.9 dB<br>10 = 21.3 dB<br>(default)        |   | 0x06          | LNA and PGA gain adjustment (global).  |
| 0x12        | bias_current       | X   | X  | X   | X     | 1   | X   | LNA bias<br>00 = high (default)<br>01 = mid-high<br>10 = mid-low<br>11 = low |   | 0x08          | LNA bias current adjustment (global).  |
| 0x14        | output_mode        | X   | 0 = LVDS ANSI-644 (default)<br>1 = LVDS low power, (IEEE 1596.3 similar) | X   | X     | X   | Output invert enable<br>1 = on<br>0 = off (default) | Data format select<br>00 = offset binary (default)<br>01 = twos complement   |   | 0x00          | Configures the outputs and the format of the data (Bits[7:3] and Bits[1:0] are global; Bit 2 is local).  |
| 0x15        | output_adjust      | X   | X  | Output driver termination<br>00 = none (default)<br>01 = 200 $\Omega$<br>10 = 100 $\Omega$<br>11 = 100 $\Omega$   |       | X   | X   | X  | DCO $\pm$ and FCO $\pm$<br>2x drive strength<br>1 = on<br>0 = off (default) | 0x00          | Determines LVDS or other output properties. Primarily functions to set the LVDS span and common-mode levels in place of an external resistor (Bits[7:1] are global; Bit 0 is local). |
| 0x16        | output_phase       | X   | X  | X   | X     | 0011 = output clock phase adjust (0000 through 1010) (Default: 180° relative to data edge)<br>0000 = 0° relative to data edge<br>0001 = 60° relative to data edge<br>0010 = 120° relative to data edge<br>0011 = 180° relative to data edge<br>0100 = 240° relative to data edge<br>0101 = 300° relative to data edge<br>0110 = 360° relative to data edge<br>0111 = 420° relative to data edge<br>1000 = 480° relative to data edge<br>1001 = 540° relative to data edge<br>1010 = 600° relative to data edge<br>1011 to 1111 = 660° relative to data edge |   |  |   | 0x03          | On devices that utilize global clock divide, determines which phase of the divider output is used to supply the output clock. Internal latching is unaffected.                       |
| 0x18        | flex_vref          | X   | 0 = internal reference<br>1 = external reference                         | X   | X     | X   | X   | X  | X   | 0x00          | Select internal reference (recommended default) or external reference (global).  |

# AD9276

| Addr. (Hex) | Register Name                    | Bit 7 (MSB)                                 | Bit 6   | Bit 5 | Bit 4  | Bit 3   | Bit 2   | Bit 1  | Bit 0 (LSB)  | Default Value  | Comments   |
|-------------|----------------------------------|---|---|-------|--|---|---|--|--|--|--|
| 0x19        | user_patt1_lsb                   | B7  | B6  | B5    | B4   | B3  | B2  | B1   | B0   | 0x00   | User-Defined Pattern 1, LSB (global).                          |
| 0x1A        | user_patt1_msb                   | B15   | B14   | B13   | B12  | B11   | B10   | B9   | B8   | 0x00   | User-Defined Pattern 1, MSB (global).                          |
| 0x1B        | user_patt2_lsb                   | B7  | B6  | B5    | B4   | B3  | B2  | B1   | B0   | 0x00   | User-Defined Pattern 2, LSB (global).                          |
| 0x1C        | user_patt2_msb                   | B15   | B14   | B13   | B12  | B11   | B10   | B9   | B8   | 0x00   | User-Defined Pattern 2, MSB (global).                          |
| 0x21        | serial_control                   | LSB first<br>1 = on<br>0 = off<br>(default) | X   | X     | X  | <10 MSPS,<br>low encode rate mode<br>1 = on<br>0 = off<br>(default)   | Serial bit stream length<br>000 = 12 bits (default, normal bit stream)<br>001 = 8 bits<br>010 = 10 bits<br>011 = 12 bits<br>100 = 14 bits |  |  | 0x00   | Serial stream control (global).                                |
| 0x22        | serial_ch_stat                   | X   | X   | X     | X  | X   | X   | Channel output reset<br>1 = on<br>0 = off<br>(default)   | Channel power-down<br>1 = on<br>0 = off<br>(default) | 0x00   | Used to power down individual sections of a converter (local). |
| 0x2B        | flex_filter                      | X   | Enable automatic low-pass tuning<br>1 = on<br>(self-clearing) | X     | X  | High-pass filter cutoff<br>0000 = $f_{LP}/20.7$<br>0001 = $f_{LP}/11.5$<br>0010 = $f_{LP}/7.9$<br>0011 = $f_{LP}/6.0$<br>0100 = $f_{LP}/4.9$<br>0101 = $f_{LP}/4.1$<br>0110 = $f_{LP}/3.5$<br>0111 = $f_{LP}/3.1$   |   |  | 0x00   | Filter cutoff (global).<br>( $f_{LP}$ = low-pass filter cutoff frequency.) |  |
| 0x2C        | analog_input                     | X   | X   | X     | X  | X   | X   | LO-x, LOSW-x connection<br>00 = (-)LNA output, high-Z<br>01 = (-)LNA output, (-)LNA output<br>10 = (-)LNA output, (+)LNA output<br>11 = high-Z, high-Z |  | 0x00   | LNA active termination/input impedance (global).               |
| 0x2D        | CW Doppler I/Q demodulator phase | X   | X   | X     | CW Doppler channel enable<br>1 = on<br>0 = off | I/Q demodulator phase<br>0000 = 0°<br>0001 = 22.5°<br>0010 = 45°<br>0011 = 67.5°<br>0100 = 90°<br>0101 = 112.5°<br>0110 = 135°<br>0111 = 157.5°<br>1000 = 180°<br>1001 = 202.5°<br>1010 = 225°<br>1011 = 247.5°<br>1100 = 270°<br>1101 = 292.5°<br>1110 = 315°<br>1111 = 337.5° |   |  |  | Phase of demodulators (local).   |  |

## APPLICATIONS INFORMATION

### POWER AND GROUND RECOMMENDATIONS

When connecting power to the AD9276, it is recommended that two separate 1.8 V supplies be used: one for analog (AVDD) and one for digital (DRVDD). If only one 1.8 V supply is available, it should be routed to the AVDD1 pin first and then tapped off and isolated with a ferrite bead or a filter choke preceded by decoupling capacitors for the DRVDD pin. The user should employ several decoupling capacitors on all supplies to cover both high and low frequencies. Locate these capacitors close to the point of entry at the PCB level and close to the part, with minimal trace lengths.

A single PCB ground plane should be sufficient when using the AD9276. With proper decoupling and smart partitioning of the analog, digital, and clock sections of the PCB, optimum performance can be easily achieved.

### EXPOSED PADDLE THERMAL HEAT SLUG RECOMMENDATIONS

It is required that the exposed paddle on the underside of the device be connected to analog ground to achieve the best electrical and thermal performance of the AD9276. An exposed continuous copper plane on the PCB should mate to the AD9276 exposed paddle, Pin 0. The copper plane should have several vias to achieve the lowest possible resistive thermal path for heat dissipation to flow through the bottom of the PCB. These vias should be solder-filled or plugged with nonconductive epoxy.

To maximize the coverage and adhesion between the device and the PCB, partition the continuous copper plane into several uniform sections by overlaying a silkscreen or solder mask on the PCB. This ensures several tie points between the AD9276 and the PCB during the reflow process, whereas using one continuous plane with no partitions guarantees only one tie point. See Figure 78 for a PCB layout example. For detailed information about packaging and for more PCB layout examples, see the AN-772 Application Note, *A Design and Manufacturing Guide for the Lead Frame Chip Scale Package (LFCSP)*, at [www.analog.com](http://www.analog.com).

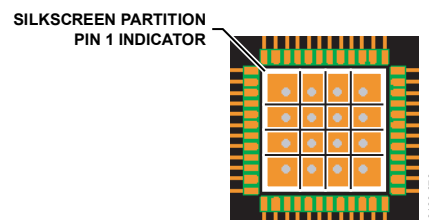
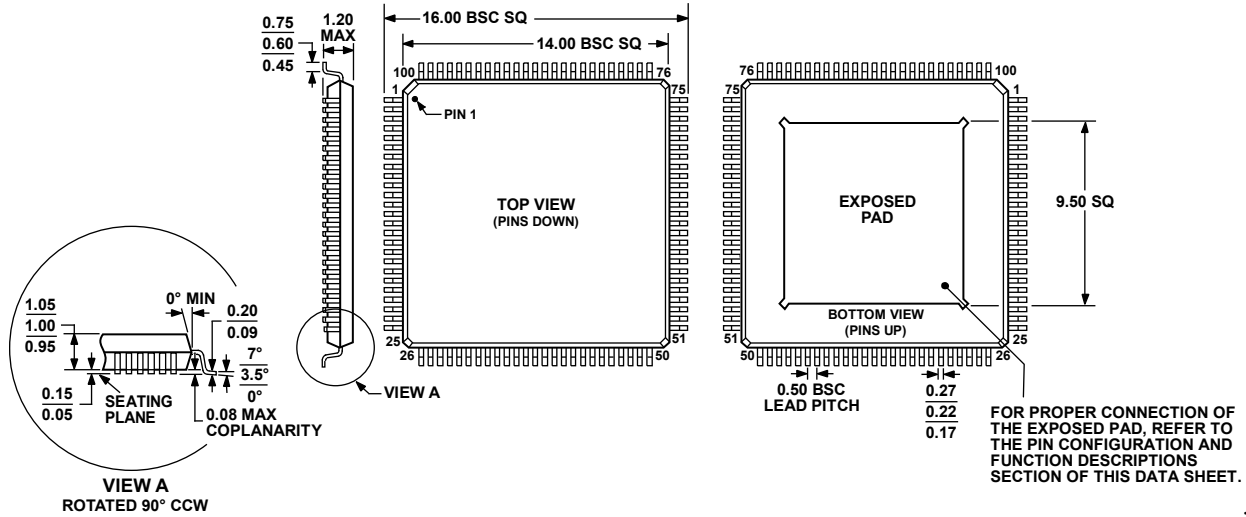

Figure 78. Typical PCB Layout

OUTLINE DIMENSIONS



COMPLIANT TO JEDEC STANDARDS MS-026-AED-HD  
 Figure 79. 100-Lead Thin Quad Flat Package, Exposed Pad [TQFP\_EP]  
 (SV-100-3)  
 Dimensions shown in millimeters

100988-A

ORDERING GUIDE

| Model                      | Temperature Range | Package Description   | Package Option |
|----------------------------|-------------------|---|----------------|
| AD9276BSVZ <sup>1</sup>    | -40°C to +85°C    | 100-Lead Thin Quad Flat Package, Exposed Pad [TQFP_EP]        | SV-100-3       |
| AD9276-65EBZ <sup>1</sup>  |                   | Evaluation Board  |                |
| AD9276-80KITZ <sup>1</sup> |                   | Evaluation Board and High Speed FPGA-Based Data Capture Board |                |

<sup>1</sup> Z = RoHS Compliant Part.

**NOTES**

**AD9276**

**NOTES**