

### FEATURES

#### General

- HDMI®/DVI transmitter compatible with HDMI v. 1.3, DVI v. 1.0, and HDCP v. 1.2
- Single 1.8 V power supply
- Video/audio inputs accept logic levels from 1.8 V to 3.3 V
- 80-lead LQFP, Pb-free package
- 64-lead LFCSP, Pb-free package
- 76-ball CSP\_BGA, Pb-free package

#### Digital video

- 165 MHz operation supports all resolutions from 480i to 1080p and UXGA at 60 Hz
- 80 MHz derivative supports all resolutions from 480i to 1080i/720p and XGA at 70 Hz
- Programmable two-way color space converter
- Supports RGB, YCbCr, and DDR
- Supports ITU656-based embedded syncs
- Automatic input video format timing detection (CEA-861B)

#### Digital audio

- Supports standard S/PDIF for stereo LPCM or compressed audio up to 192 kHz
- 8-channel, uncompressed, LPCM I<sup>2</sup>S audio up to 192 kHz

#### Special features for easy system design

- On-chip MPU with I<sup>2</sup>C master to perform HDCP operations and EDID reading operations
- 5 V tolerant I<sup>2</sup>C and HPD I/Os, no extra device needed
- No audio master clock needed for supporting S/PDIF and I<sup>2</sup>S
- On-chip MPU reports HDMI events through interrupts and registers

### APPLICATIONS

DVD players and recorders

Digital set-top boxes

A/V receivers

Digital cameras and camcorders

HDMI repeater/splitter

### GENERAL DESCRIPTION

The AD9889B is a 165 MHz, high definition multimedia interface (HDMI) v. 1.3 transmitter. It supports HDTV formats up to 1080p, and computer graphic resolutions up to UXGA (1600 × 1200 at 60 Hz). With the inclusion of HDCP, the AD9889B allows the secure transmission of protected content as specified by the HDCP v. 1.2 protocol.

Rev. B

[Document Feedback](#)

Information furnished by Analog Devices is believed to be accurate and reliable. However, no responsibility is assumed by Analog Devices for its use, nor for any infringements of patents or other rights of third parties that may result from its use. Specifications subject to change without notice. No license is granted by implication or otherwise under any patent or patent rights of Analog Devices. Trademarks and registered trademarks are the property of their respective owners.

### FUNCTIONAL BLOCK DIAGRAM

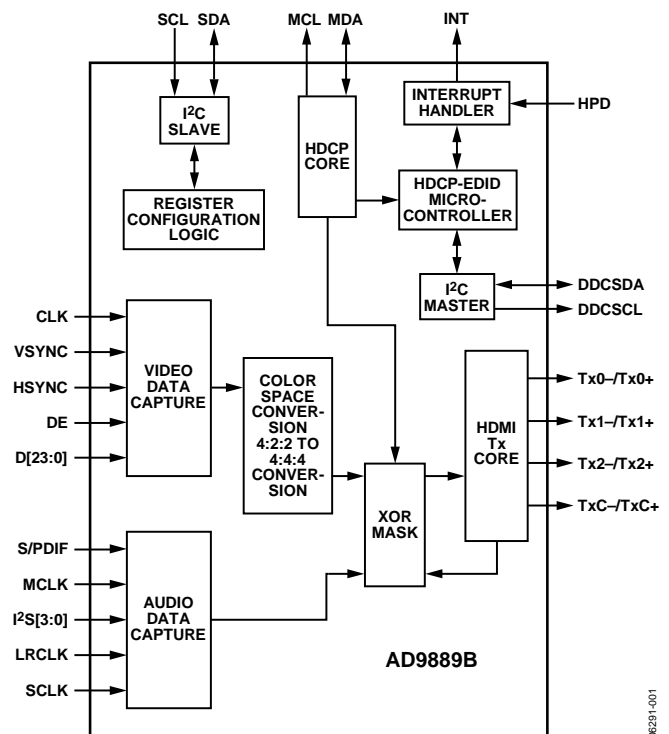

Figure 1.

The AD9889B supports both S/PDIF and 8-channel I<sup>2</sup>S audio. Its high fidelity, 8-channel I<sup>2</sup>S can transmit either stereo or 7.1 surround audio at 192 kHz. The S/PDIF can carry stereo LPCM audio or compressed audio, including DTS®, THX®, and Dolby® Digital.

The AD9889B helps reduce system design complexity and cost by incorporating such features as an internal MPU for HDCP operations, an I<sup>2</sup>C master for EDID reading, a single 1.8 V power supply, and 5 V tolerance on the I<sup>2</sup>C and hot plug detect pins.

Fabricated in an advanced CMOS process, the AD9889B is available in a space-saving, 76-ball CSP\_BGA or 64-lead LFCSP surface-mount package, and an 80-lead LQFP surface-mount package. All packages are available as Pb-free and are specified from -25°C to +85°C.

## TABLE OF CONTENTS

Features .....	1	Applications Information .....	8
Applications.....	1	Design Resources .....	8
General Description .....	1	Document Conventions .....	8
Functional Block Diagram .....	1	PCB Layout Recommendations.....	9
Revision History .....	2	Power Supply Bypassing.....	9
Specifications.....	3	Digital Inputs .....	9
Absolute Maximum Ratings.....	4	External Swing Resistor .....	9
Explanation of Test Levels.....	4	Output Signals .....	9
ESD Caution.....	4	Outline Dimensions .....	10
Pin Configurations and Function Descriptions .....	5	Ordering Guide .....	11

## REVISION HISTORY

### 12/14—Rev. A to Rev. B

Changes to Features Section.....	1
Changes to CLK Frequency Parameter, Table 1 .....	3
Updated Outline Dimensions.....	11

### 3/10—Rev. 0 to Rev. A

Changes to Clock Frequency Parameter, Table 1 .....	3
Changes to Digital Inputs Parameter, Table 2.....	5
Changes to Table 3.....	7
Changes to Design Resources Section .....	9

### 4/07—Revision 0: Initial Version

## SPECIFICATIONS

Table 1.

Parameter	Test Conditions/Comments	Temp	Test Level <sup>1</sup>	Min	Typ	Max	Unit
DIGITAL INPUTS							
Input Voltage, High ( $V_{IH}$ )		Full	VI	1.4		3.5	V
Input Voltage, Low ( $V_{IL}$ )		Full	VI			0.7	V
Input Capacitance		25°C	V		3		pF
DIGITAL OUTPUTS							
Output Voltage, High ( $V_{OH}$ )		Full	VI	$V_{DD} - 0.1$			V
Output Voltage, Low ( $V_{OL}$ )		Full	VI			0.4	V
THERMAL CHARACTERISTICS							
Thermal Resistance							
$\theta_{JC}$ Junction to Case			V		15.2		°C/W
$\theta_{JA}$ Junction to Ambient			V		59		°C/W
Ambient Temperature		Full	V	-25	+25	+85	°C
DC SPECIFICATIONS							
Input Leakage Current, $I_{IL}$		25°C	VI	-10		+10	$\mu$ A
Input Clamp Voltage	-16 mA	25°C	V		-0.8		V
	+16 mA	25°C	V		+0.8		V
Differential High Level Output Voltage			V		$AV_{CC}$		V
Differential Output Short-Circuit Current			IV			10	$\mu$ A
POWER SUPPLY							
$V_{DD}$ (All) Supply Voltage		Full	IV	1.71	1.8	1.89	V
$V_{DD}$ Supply Voltage Noise		Full	V			50	mV p-p
Power-Down Current	With active video applied, 165 MHz, typical random pattern	25°C	IV		9		mA
Transmitter Supply Current	With active video applied, 165 MHz, typical random pattern	25°C	IV		240	280	mA
Transmitter Total Power		Full	VI		432	504	mW
AC SPECIFICATIONS							
CLK Frequency	165 MHz derivative	25°C	IV	13.5		165	MHz
	80 MHz derivative	25°C	IV	13.5		80	MHz
TMD5 Output CLK Duty Cycle		25°C	IV	48		52	%
Worst Case CLK Input Jitter		Full	IV			2	ns
Input Data Setup Time		Full	IV	1			ns
Input Data Hold Time		Full	IV	1			ns
TMD5 Differential Swing			VI	800	1000	1200	mV
$V_{SYNC}$ and $H_{SYNC}$ Delay from DE Falling Edge			VI		1		UI <sup>2</sup>
$V_{SYNC}$ and $H_{SYNC}$ Delay to DE Rising Edge			VI		1		UI <sup>2</sup>
DE High Time		25°C	VI			8191	UI <sup>2</sup>
DE Low Time		25°C	VI		138		UI <sup>2</sup>
Differential Output Swing							
Low to High Transition Time		25°C	VII	75		490	ps
High to Low Transition Time		25°C	VII	75		490	ps
AUDIO AC TIMING							
Sample Rate	I <sup>2</sup> S and S/PDIF	Full	IV	32		192	kHz
I <sup>2</sup> S Cycle Time		25°C	IV			1	UI <sup>2</sup>
I <sup>2</sup> S Setup Time		25°C	IV		15		ns
I <sup>2</sup> S Hold Time		25°C	IV		0		ns
Audio Pipeline Delay		25°C	IV		75		$\mu$ s

<sup>1</sup> See Explanation of Test Levels section.<sup>2</sup> UI = unit interval.

## ABSOLUTE MAXIMUM RATINGS

Table 2.

Parameter	Rating
Digital Inputs	+5.5 V to -0.3 V
Digital Output Current	20 mA
Operating Temperature Range	-40°C to +85°C
Storage Temperature Range	-65°C to +150°C
Maximum Junction Temperature	150°C
Maximum Case Temperature	150°C

Stresses at or above those listed under Absolute Maximum Ratings may cause permanent damage to the product. This is a stress rating only; functional operation of the product at these or any other conditions above those indicated in the operational section of this specification is not implied. Operation beyond the maximum operating conditions for extended periods may affect product reliability.

## EXPLANATION OF TEST LEVELS

- I. 100% production tested.
- II. 100% production tested at 25°C and sample tested at specified temperatures.
- III. Sample tested only.
- IV. Parameter is guaranteed by design and characterization testing.
- V. Parameter is a typical value only.
- VI. 100% production tested at 25°C; guaranteed by design and characterization testing.
- VII. Limits defined by HDMI specification; guaranteed by design and characterization testing.

## ESD CAUTION



### ESD (electrostatic discharge) sensitive device.

Charged devices and circuit boards can discharge without detection. Although this product features patented or proprietary protection circuitry, damage may occur on devices subjected to high energy ESD. Therefore, proper ESD precautions should be taken to avoid performance degradation or loss of functionality.

# PIN CONFIGURATIONS AND FUNCTION DESCRIPTIONS

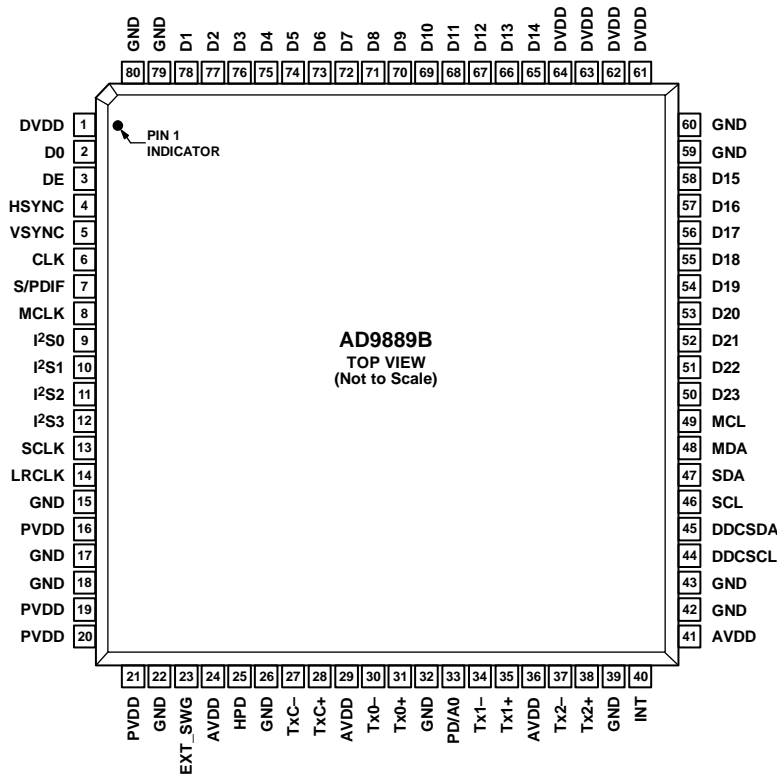
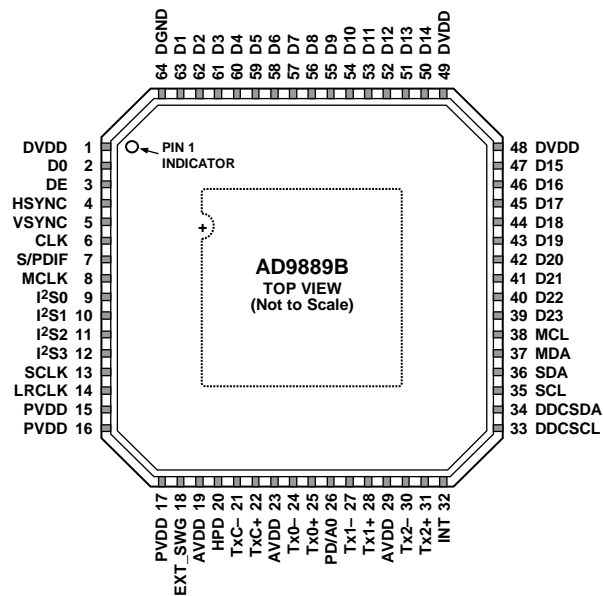

Figure 2. 80-Lead LQFP Pin Configuration (Top View)



NOTES  
1. GND PADDLE ON BOTTOM OF PACKAGE.

Figure 3. 64-Lead LFCSP Pin Configuration (Top View)

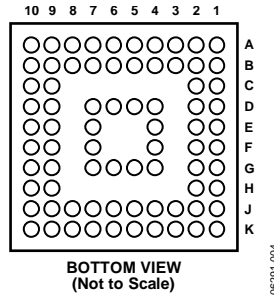

Figure 4. 76-Ball BGA Configuration (Top View)

Table 3. Pin Function Descriptions

Pin No.			Mnemonic	Type <sup>1</sup>	Description
BGA	LFCSP	LQFP			
D10, D9, C10, C9, A10, B10, A9, B9, A8, B8, A7, B7, A6, B6, A5, B5, A4, B4, A3, B3, A2, B2, A1, B1	39 to 47, 50 to 63, 2	50 to 58, 65 to 78, 2	D[23:0]	I	Video Data Input. Digital input in RGB or YCbCr format. Supports CMOS logic levels from 1.8V to 3.3V.
D1	6	6	CLK	I	Video Clock Input. Supports CMOS logic levels from 1.8V to 3.3V.
C2	3	3	DE	I	Data Enable Bit for Digital Video. Supports CMOS logic levels from 1.8V to 3.3V.
C1	4	4	HSYNC	I	Horizontal Sync Input. Supports CMOS logic levels from 1.8V to 3.3V.
D2	5	5	VSYNC	I	Vertical Sync Input. Supports CMOS logic levels from 1.8V to 3.3V.
J3	18	23	EXT_SWG	I	Sets Internal Reference Currents. Place 887 Ω resistor (1% tolerance) between this pin and ground.
K3	20	25	HPD	I	Hot Plug Detect Signal. This indicates to the interface whether the receiver is connected. Supports 1.8V to 5.0V CMOS logic levels.
E2	7	7	S/PDIF	I	S/PDIF (Sony/Philips Digital Interface) Audio Input. This is the audio input from a Sony/Philips digital interface. Supports CMOS logic levels from 1.8V to 3.3V.
E1	8	8	MCLK	I	Audio Reference Clock. 128 × N × f <sub>s</sub> with N = 1, 2, 3, or 4. Set to 128 × sampling frequency (f <sub>s</sub> ), 256 × f <sub>s</sub> , 384 × f <sub>s</sub> , or 512 × f <sub>s</sub> . Supports 1.8V to 3.3V CMOS logic levels.
F2, F1, G2, G1	9 to 12	9 to 12	I <sup>2</sup> S[3:0]	I	I <sup>2</sup> S Audio Data Inputs. These represent the eight channels of audio (two per input) available through I <sup>2</sup> S. Supports CMOS logic levels from 1.8V to 3.3V.
H2	13	13	SCLK	I	I <sup>2</sup> S Audio Clock. Supports CMOS logic levels from 1.8V to 3.3V.
H1	14	14	LRCLK	I	Left/Right Channel Selection. Supports CMOS logic levels from 1.8V to 3.3V.
J7 <sup>2</sup>	26 <sup>2</sup>	33 <sup>2</sup>	PD/A0	I	Power-Down Control and I <sup>2</sup> C Address Selection. The I <sup>2</sup> C address and the PD polarity are set by the PD/A0 pin state when the supplies are applied to the AD9889B. Supports 1.8V to 3.3V CMOS logic levels.
K1, K2	21, 22	27, 28	TxC−/TxC+	O	Differential Clock Output. Differential clock output at pixel clock rate; supports TMDS logic level.
K10, J10	30, 31	37, 38	Tx2−/Tx2+	O	Differential Output Channel 2. Differential output of the red data at 10× the pixel clock rate; supports TMDS logic level.

Pin No.			Mnemonic	Type <sup>1</sup>	Description
BGA	LFCSP	LQFP			
K7, K8	27, 28	34, 35	Tx1–/Tx1+	O	Differential Output Channel 1. Differential output of the green data at 10× the pixel clock rate; supports TMDS logic level.
K4, K5	24, 25	30, 31	Tx0–/Tx0+	O	Differential Output Channel 0. Differential output of the blue data at 10× the pixel clock rate; TMDS logic level.
H10	32	40	INT	O	Interrupt. Open drain. A 2 kΩ pull-up resistor to the microcontroller I/O supply is recommended.
J2, J5, J8, K9	19, 23, 29	24, 29, 36, 41	AVDD	P	1.8 V Power Supply for TMDS Outputs.
D5, D6, D7, E7	1, 48, 49	1, 61, 62, 63, 64	DVDD	P	1.8 V Power Supply for Digital and I/O Power Supply. These pins supply power to the digital logic and I/Os. They should be filtered and as quiet as possible.
G4, G5, J1	15, 16, 17,	16, 19, 20, 21	PVDD	P	1.8 V PLL Power Supply. The most sensitive portion of the AD9889B is the clock generation circuitry. These pins provide power to the clock PLL. The designer should provide quiet, noise-free power to these pins.
D4, E4, F4, J4, G6, J6, K6, F7, G7, H9, J9	N/A	15, 17, 18, 22, 26, 32, 39, 42, 43, 59, 60, 79, 80	GND	P	Ground. The ground return for all circuitry on-chip. For best practice, assemble the AD9889B on a single, solid ground plane with careful attention given to ground current paths.
N/A	64, paddle on bottom side	N/A	DGND	P	Digital Ground. The ground return for all circuitry on-chip. For best practice, assemble the AD9889B on a single, solid ground plane with careful attention given to ground current paths.
F9	36	47	SDA	C <sup>3</sup>	Serial Port Data I/O. This pin serves as the serial port data I/O slave for register access. Supports CMOS logic levels from 1.8 V to 3.3 V.
F10	35	46	SCL	C <sup>3</sup>	Serial Port Data Clock. This pin serves as the serial port data clock slave for register access. Supports CMOS logic levels from 1.8 V to 3.3 V.
E10	37	48	MDA	C <sup>3</sup>	Serial Port Data I/O Master to HDCP Key EEPROM. Supports CMOS logic levels from 1.8 V to 3.3 V.
E9	38	49	MCL	C <sup>3</sup>	Serial Port Data Clock Master to HDCP Key EEPROM. Supports CMOS logic levels from 1.8 V to 3.3 V.
G9	34	45	DDCSDA	C <sup>3</sup>	Serial Port Data I/O to Receiver. This pin serves as the master to the DDC bus. Supports a 5 V CMOS logic level.
G10	33	44	DDCSCL	C <sup>3</sup>	Serial Port Data Clock to Receiver. This pin serves as the master clock for the DDC bus. Supports a 5 V CMOS logic level.

<sup>1</sup> I = input, O = output, P = power supply, C = control.

<sup>2</sup> Pin J7 (BGA), Pin 26 (LFCSP), and Pin 33 (LQFP) are dual function pins: I<sup>2</sup>C selection and power-down control. The I<sup>2</sup>C selection function occurs at power-up; the power-down control function occurs whenever the state of the pin is changed from its original state at power-up.

<sup>3</sup> For a full description of the 2-wire serial interface and its functionality, obtain documentation by contacting NDA from [ATV\\_VideoTx\\_Apps@analog.com](mailto:ATV_VideoTx_Apps@analog.com).

## APPLICATIONS INFORMATION

### DESIGN RESOURCES

Analog Devices, Inc. evaluation kits, reference design schematics, and other support documentation are available under the nondisclosure agreement (NDA) from [ATV\\_VideoTx\\_Apps@analog.com](mailto:ATV_VideoTx_Apps@analog.com).

Other resources include:

*EIA/CEA-861B*, which describes audio and video inframes as well as the E-EDID structure for HDMI. It is available from Consumer Electronics Association (CEA).

The *HDMI v. 1.3*, a defining document for HDMI Version 1.3, and the *HDMI Compliance Test Specification Version 1.3* are available from HDMI Licensing, LLC.

The *HDCP v. 1.2* is the defining document for HDCP Version 1.2 available from Digital Content Protection, LLC.

### DOCUMENT CONVENTIONS

In this data sheet, data is represented using the conventions described in Table 4.

**Table 4. Document Conventions**

Data Type	Format
0xNN	Hexadecimal (Base-16) numbers are represented using the C language notation, preceded by 0x.
0bNN	Binary (Base-2) numbers are represented using the C language notation, preceded by 0b.
NN	Decimal (Base-10) numbers are represented using no additional prefixes or suffixes.
Bit	Bits are numbered in little endian format, that is, the least significant bit of a byte or word is referred to as Bit 0.



## PCB LAYOUT RECOMMENDATIONS

The AD9889B is a high precision, high speed analog device. As such, to obtain the maximum performance from the part, it is important to have a well laid out board.

### POWER SUPPLY BYPASSING

It is recommended to bypass each power supply pin with a 0.1  $\mu\text{F}$  capacitor. The exception is when two or more supply pins are adjacent to each other. For these groupings of powers/grounds, it is necessary to have only one bypass capacitor. The fundamental idea is to have a bypass capacitor within about 0.5 cm of each power pin. Also, avoid placing the capacitor on the opposite side of the PC board from the AD9889B, as that interposes resistive vias in the path.

The bypass capacitors should be physically located between the power plane and the power pin. Current should flow from the power plane to the capacitor to the power pin. Do not make a power connection between the capacitor and the power pin. Placing a via underneath the capacitor pads, down to the power plane, is generally the best approach.

It is particularly important to maintain low noise and good stability of PVDD (the PLL supply). Abrupt changes in PVDD can result in similarly abrupt changes in sampling clock phase and frequency. This can be avoided by careful attention to regulation, filtering, and bypassing. It is best practice to provide separate regulated supplies for each of the analog circuitry groups (AVDD and PVDD).

It is also recommended to use a single ground plane for the entire board. Experience has repeatedly shown that the noise performance is the same or better with a single ground plane. Using multiple ground planes can be detrimental because each separate ground plane is smaller, and long ground loops can result.

### DIGITAL INPUTS

#### *Video and Audio Data Input Signals*

The digital inputs on the AD9889B are designed to work with signals ranging from 1.8 V to 3.3 V logic levels. Therefore, no extra components need to be added when using 3.3 V logic. Any noise that gets onto the clock input (labeled CLK) trace adds jitter to the system. Therefore, minimize the video clock input (Pin 6: CLK) trace length and do not run any digital or other high frequency traces near it. Make sure to match the length of the input data signals to optimize data capture, especially for high frequency modes such as 1080p, UXGA, and double data rate input formats.

#### *Other Input Signals*

The HPD must be connected to the HDMI connector. A 10 k $\Omega$  pull-down resistor to ground is also recommended.

The PD/A0 input pin can be connected to GND or supply (through a resistor or a control signal). The device address and power-down polarity are set by the state of the PD/A0 pin when the AD9889B supplies are applied/enabled. For example, if the PD/A0 pin is low (when the supplies are turned on), then the device address is 0x72 and the power-down is active high. If the PD/A0 pin is high (when the supplies are turned on), the device address is 0x7A and the power-down is active low.

The SCL and SDA pins should be connected to the I<sup>2</sup>C master. A pull-up resistor of 2 k $\Omega$  to 1.8 V or 3.3 V is recommended.

### EXTERNAL SWING RESISTOR

The external swing resistor must be connected directly to the EXT\_SWG pin and ground. The external swing resistor must have a value of 887  $\Omega$  ( $\pm 1\%$  tolerance). Avoid running any high speed ac or noisy signals next to, or close to, the EXT\_SWG pin.

### OUTPUT SIGNALS

#### *TMDS Output Signals*

The AD9889B has three TMDS data channels (0, 1, and 2) that output signals up to 800 MHz as well as the TMDS output data clock. To minimize the channel-to-channel skew, make the trace length of these signals the same. Additionally, these traces need to have a 50  $\Omega$  characteristic impedance and need to be routed as 100  $\Omega$  differential pairs. Best practice recommends routing these lines on the top PCB layer to avoid the use of vias.

#### *Other Output Signals (non TMDS)*

#### **DDCSCL and DDCSDA**

The DDCSCL and DDCSDA outputs need to have a minimum amount of capacitance loading to ensure the best signal integrity. The DDCSCL and DDCSDA capacitance loading must be less than 50 pF to meet the HDMI compliance specification. The DDCSCL and DDCSDA must be connected to the HDMI connector and a pull-up resistor to 5 V is required. The pull-up resistor must have a value between 1.5 k $\Omega$  and 2 k $\Omega$ .

#### **INT Pin**

The INT pin is an output that should be connected to the micro-controller of the system. A pull-up resistor to 1.8 V or 3.3 V is required for proper operation—the recommended value is 2 k $\Omega$ .

#### **MCL and MDA**

The MCL and MDA outputs should be connected to the EEPROM containing the HDCP key (if HDCP is implemented). Pull-up resistors of 2 k $\Omega$  are recommended.

OUTLINE DIMENSIONS

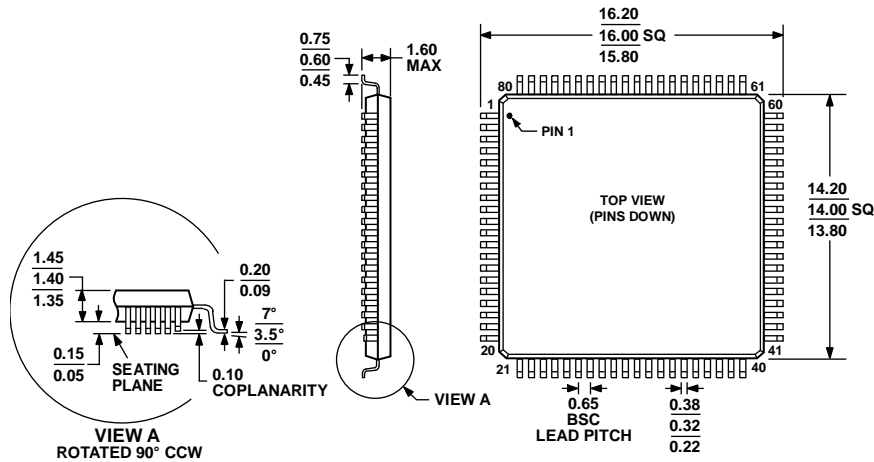

COMPLIANT TO JEDEC STANDARDS MS-026-BEC  
 Figure 5. 80-Lead Low Profile Quad Flat Package [LQFP]  
 (ST-80-2)  
 Dimensions shown in millimeters

051706-A

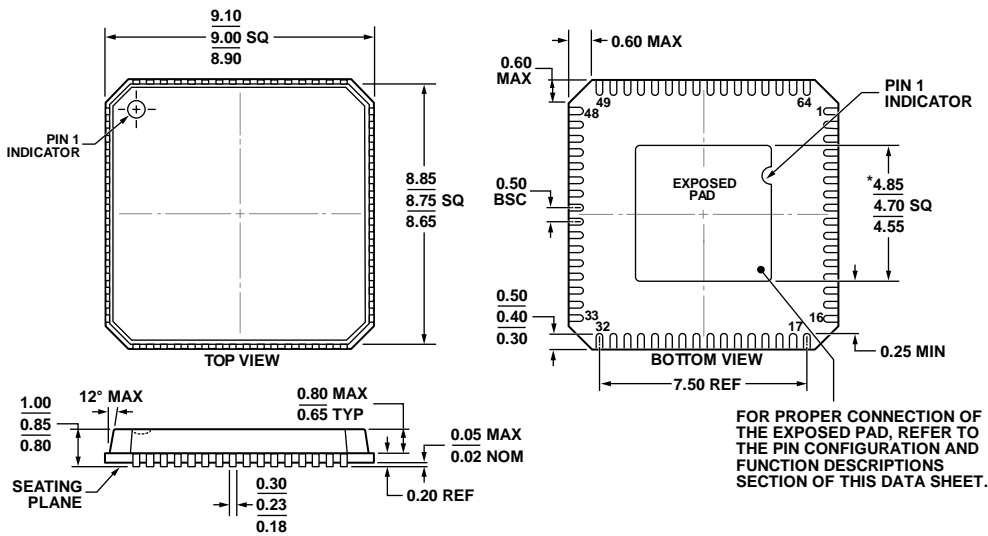

\*COMPLIANT TO JEDEC STANDARDS MO-220-VMM-4  
 EXCEPT FOR EXPOSED PAD DIMENSION  
 Figure 6. 64-Lead Lead Frame Chip Scale Package [LFCSP\_VQ]  
 9 mm x 9 mm Body, Very Thin Quad  
 (CP-64-1)  
 Dimensions shown in millimeters

FOR PROPER CONNECTION OF  
 THE EXPOSED PAD, REFER TO  
 THE PIN CONFIGURATION AND  
 FUNCTION DESCRIPTIONS  
 SECTION OF THIS DATA SHEET.

06-13-2012-A

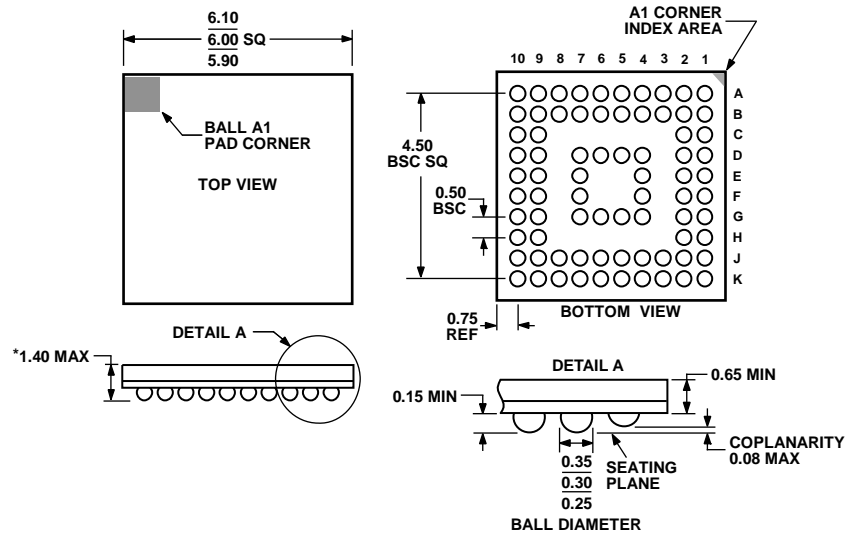

\*COMPLIANT TO JEDEC STANDARDS MO-225  
WITH THE EXCEPTION TO PACKAGE HEIGHT.

Figure 7. 76-Ball Chip Scale Package Ball Grid Array [CSP\_BGA]  
6 mm × 6 mm × 1.4 mm  
(BC-76-1)  
Dimensions shown in millimeters

0108897-A

**ORDERING GUIDE**

Model <sup>1</sup>	Temperature Range	Package Description	Package Option
AD9889BBCPZ-80	-25°C to +85°C	64-Lead Lead Frame Chip Scale Package [LFCSP_VQ]	CP-64-1
AD9889BBCPZ-165	-25°C to +85°C	64-Lead Lead Frame Chip Scale Package [LFCSP_VQ]	CP-64-1
AD9889BBSTZ-80	-25°C to +85°C	80-Lead Low Profile Quad Flat Package [LQFP]	ST-80-2
AD9889BBSTZ-165	-25°C to +85°C	80-Lead Low Profile Quad Flat Package [LQFP]	ST-80-2
AD9889BBCZ-80	-25°C to +85°C	76-Ball Chip Scale Package Ball Grid Array [CSP_BGA]	BC-76-1
AD9889BBCZRL-80	-25°C to +85°C	76-Ball Chip Scale Package Ball Grid Array [CSP_BGA]	BC-76-1

<sup>1</sup> Z = RoHS Compliant Part.

I<sup>2</sup>C refers to a communications protocol originally developed by Philips Semiconductors (now NXP Semiconductors).