

# ACPL-227 / ACPL-247

## DC Input Multi-Channel Half-Pitch Phototransistor Optocoupler



### Data Sheet



**Lead (Pb) Free**  
RoHS 6 fully compliant

RoHS 6 fully compliant options available;  
-xxxE denotes a lead-free product

#### Description

The ACPL-227 is a DC-input dual channel half-pitch phototransistor optocoupler which contains two light emitting diodes optically coupled to two separate phototransistors. It is packaged in an 8-pin SO package.

Likewise, the ACPL-247 is a DC-input quad channel half-pitch phototransistor optocoupler which contains four light emitting diodes optically coupled to four separate phototransistors. It is packaged in a 16-pin SO package.

For both devices, the input-output isolation voltage is rated at 3,000 Vrms. Response time,  $t_r$ , is 2 $\mu$ s typically, while minimum CTR is 50% at input current of 5 mA.

#### ACPL-227 pin layout

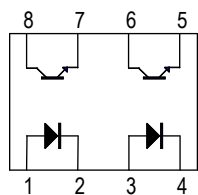

Pin 1, 3	Anode
Pin 2, 4	Cathode
Pin 5, 7	Emitter
Pin 6, 8	Collector

#### ACPL-247 pin layout

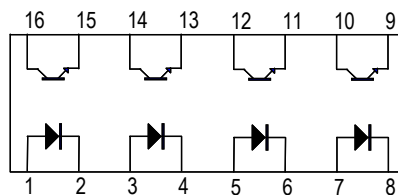

Pin 1, 3, 5, 7	Anode
Pin 2, 4, 6, 8	Cathode
Pin 9, 11, 13, 15	Emitter
Pin 10, 12, 14, 16	Collector

#### Features

- Current transfer ratio (CTR: 50% (min) at  $I_F = 5\text{mA}$ ,  $V_{CE} = 5\text{V}$ )
- High input-output isolation voltage ( $V_{ISO} = 3,000V_{RMS}$ )
- Non-saturated Response time ( $t_r$ : 2 $\mu$ s (typ) at  $V_{CC} = 10\text{V}$ ,  $I_C = 2\text{mA}$ ,  $R_L = 100\Omega$ )
- SO package
- CMR 10kV/ $\mu$ s (typical)
- Safety and regulatory approvals
  - UL
  - CSA
  - IEC/EN/DIN EN 60747-5-2
- Options available:
  - CTR Ranks 0, B & C for ACPL-227 and Rank 0 only for ACPL-247

#### Applications

- I/O Interface for Programmable controllers, computers.
- Sequence controllers
- System appliances, measuring instruments
- Signal transmission between circuits of different potentials and impedances.

## Ordering Information

ACPL-2x7-xxxx is UL recognized at 3,000 Vrms for 1 minute per UL1577 and is approved under CSA Component Acceptance Notice #5, File CA 88324.

Part number	RoHS Compliant Option				Package	No. Of Channels	Surface Mount	Tape & Reel	IEC/EN/DIN EN 60747-5-2	Quantity
	Rank '0' 50% <CTR< 600%	Rank '0' 100% <CTR< 600%	Rank 'B' 130% <CTR< 260%	Rank 'C' 200% <CTR< 400%						
ACPL-227	I <sub>F</sub> =5mA V <sub>CE</sub> =5V	I <sub>F</sub> =5mA V <sub>CE</sub> =5V	I <sub>F</sub> =5mA V <sub>CE</sub> =5V	I <sub>F</sub> =5mA V <sub>CE</sub> =5V	SO-8	Dual	X	X		2000 pcs per reel
					SO-8	Dual	X	X	X	2000 pcs per reel
ACPL-247		-500E			SO-16	Quad	X	X		2000 pcs per reel
		-560E			SO-16	Quad	X	X	X	2000 pcs per reel

To order, choose a part number from the part number column and combine with the desired option from the option column to form an order entry.

### Example 1:

ACPL-227-56CE to order product of Dual Channel SO-8 Surface Mount package in Tape & Reel with IEC/EN/DIN EN 60747-5-2 Safety Approval, 200%<CTR<400% and RoHS compliant.

### Example 2:

ACPL-247-500E to order product of Quad Channel SO-16 Surface Mount package in Tape and Reel packaging with 100%<CTR<600% and RoHS compliant.

Option datasheets are available. Contact your Avago sales representative or authorized distributor for information.

# Package Outline Drawings

## ACPL-227 PACKAGE OUTLINE

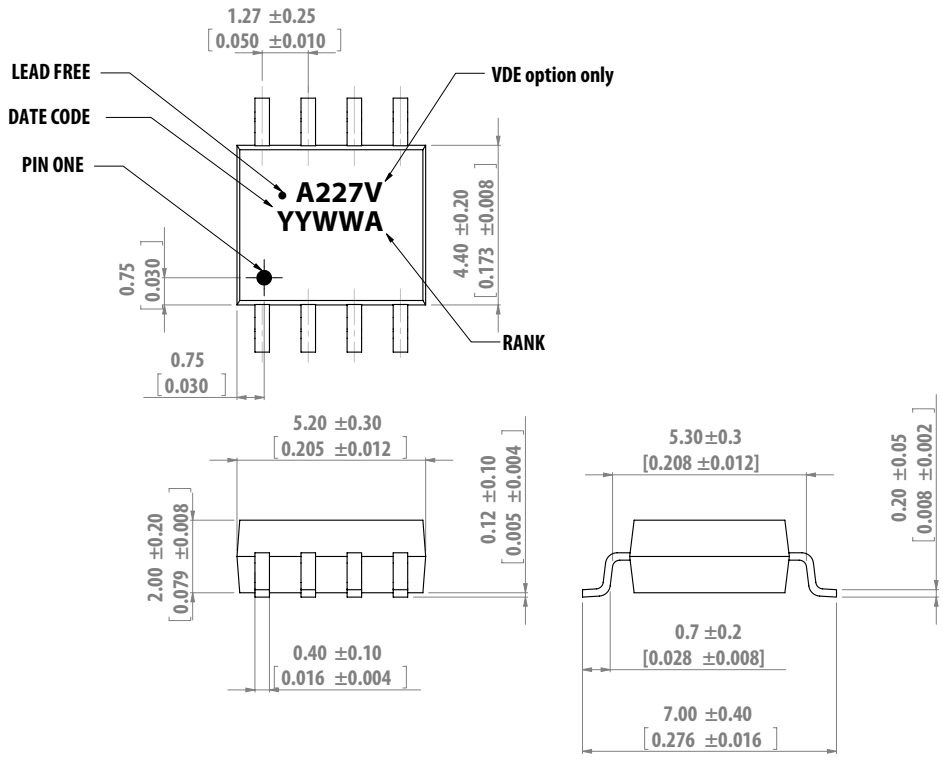

DIMENSIONS IN MILLIMETERS [INCHES]

## ACPL-247 PACKAGE OUTLINE

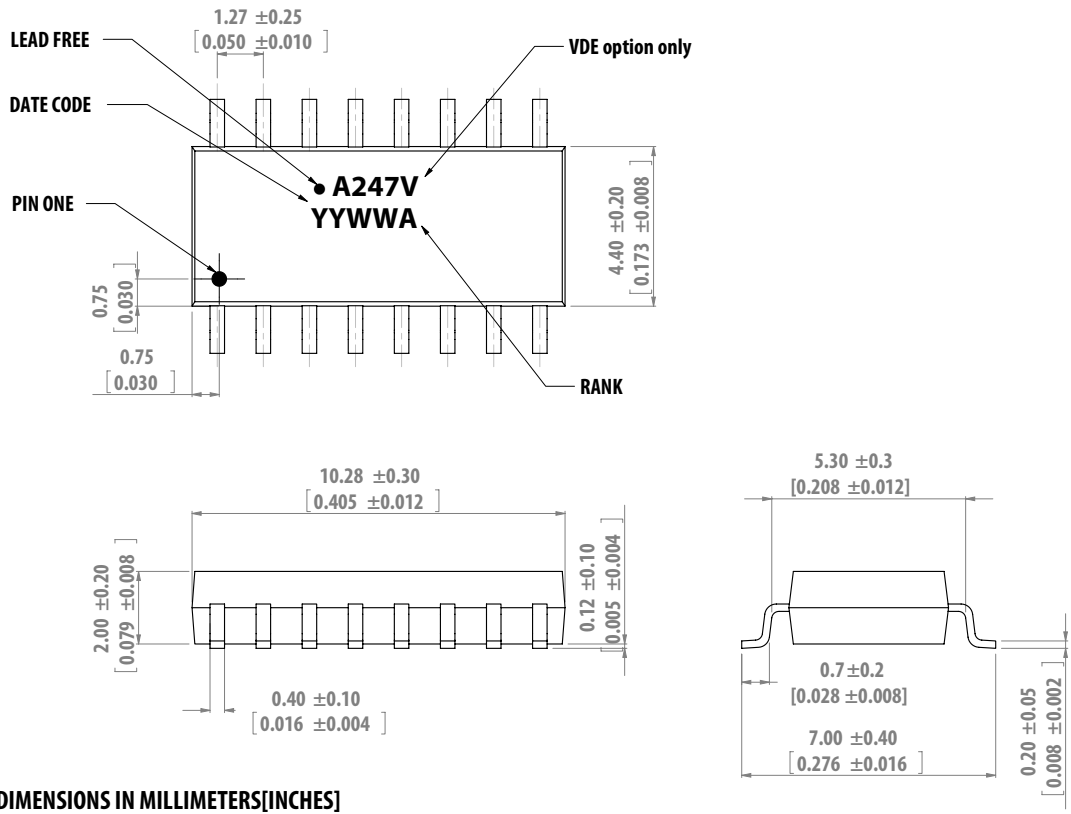

DIMENSIONS IN MILLIMETERS [INCHES]

## Solder Reflow Temperature Profile

Recommended reflow condition as per JEDEC Standard, J-STD-020 (latest revision). Non-Halide Flux should be used.

## Absolute Maximum Ratings

Parameter	Symbol	ACPL-227	ACPL-247	Units	Note
Storage Temperature	T <sub>S</sub>	-55~125		°C	
Operating Temperature	T <sub>A</sub>	-55~110		°C	
Average Forward Current	I <sub>F(AVG)</sub>	50		mA	
Pulse Forward Current	I <sub>FSM</sub>	1		A	
Reverse Voltage	V <sub>R</sub>	6		V	
LED Power Dissipation (1 channel)	P <sub>I</sub>	65		mW	
Collector Current	I <sub>C</sub>	50		mA	
Collector-Emitter Voltage	V <sub>CEO</sub>	80		V	
Emitter-Collector Voltage	V <sub>ECO</sub>	7		V	
Isolation Voltage (AC for 1 min, R.H. 40~60%)	V <sub>ISO</sub>	3,000		V <sub>RMS</sub>	1min
Collector Power Dissipation (1 channel)	P <sub>C</sub>	150	100	mW	
Total Power Dissipation	P <sub>TOT</sub>	200	170	mW	
Lead Solder Temperature		260+0/-5°C for 30 sec., 1.6 mm below seating plane			

## Electrical Specifications (DC)

Over recommended ambient temperature at 25°C unless otherwise specified.

Parameter	Symbol	Min.	Typ.	Max.	Units	Test Conditions	Note
Forward Voltage	$V_F$	-	1.2	1.4	V	$I_F = 20\text{mA}$	Fig.6
Reverse Current	$I_R$	-	-	10	$\mu\text{A}$	$V_R = 5\text{V}$	
Terminal Capacitance	$C_t$	-	30	-	pF	$V = 0, f = 1\text{MHz}$	
Collector Dark Current	$I_{CEO}$	-	-	100	nA	$V_{CE} = 48\text{V}, I_F = 0\text{mA}$	Fig.12
Collector-Emitter Breakdown Voltage	$BV_{CEO}$	80	-	-	V	$I_C = 0.5\text{mA}, I_F = 0\text{mA}$	
Emitter-Collector Breakdown Voltage	$BV_{ECO}$	7	-	-	V	$I_E = 100\mu\text{A}, I_F = 0\text{mA}$	
Current Transfer Ratio (ACPL-227 Only)	CTR	50	-	600	%	$I_F = 5\text{mA}, V_{CE} = 5\text{V}$	$CTR = (I_C/I_F) * 100\%$
Current Transfer Ratio (ACPL-247 Only)	CTR	100	-	600	%	$I_F = 5\text{mA}, V_{CE} = 5\text{V}$	$CTR = (I_C/I_F) * 100\%$
Saturated CTR	CTR(sat)	-	60	-	%	$I_F = 1\text{mA}, V_{CE} = 0.4\text{V}$	
Collector-Emitter Saturation Voltage	$V_{CE(sat)}$	-	-	0.4	V	$I_F = 8\text{mA}, I_C = 2.4\text{mA}$	Fig.14
Isolation Resistance	$R_{iso}$	$5 \times 10^{10}$	$1 \times 10^{11}$	-	$\Omega$	DC500V, R.H. 40~60%	
Floating Capacitance	$C_F$	-	0.6	1	pF	$V = 0, f = 1\text{MHz}$	
Cut-off Frequency (-3dB)	$F_C$	-	80	-	kHz	$V_{CC} = 5\text{V}, I_C = 2\text{mA}, R_L = 100\Omega$	Fig. 2,19
Response Time (Rise)	$t_r$	-	2	-	$\mu\text{s}$	$V_{CC} = 10\text{V}, I_C = 2\text{mA}, R_L = 100\Omega$	Fig. 1
Response Time (Fall)	$t_f$	-	3	-	$\mu\text{s}$		
Turn-on Time	$t_{on}$	-	3	-	$\mu\text{s}$		
Turn-off Time	$t_{off}$	-	3	-	$\mu\text{s}$		
Turn-ON Time	$t_{ON}$	-	2	-	$\mu\text{s}$	$V_{CC} = 5\text{V}, I_F = 16\text{mA}, R_L = 1.9\text{k}\Omega$	Fig. 1, 17
Storage Time	$T_S$	-	25	-	$\mu\text{s}$		
Turn-OFF Time	$t_{OFF}$	-	40	-	$\mu\text{s}$		
Common Mode Rejection Voltage	CMR	-	10	-	kV/ $\mu\text{s}$	$T_a = 25^\circ\text{C}, R_L = 470\Omega, V_{CM} = 1.5\text{kV(peak)}, I_F = 0\text{mA}, V_{CC} = 9\text{V}, V_{np} = 100\text{mV}$	Fig.20

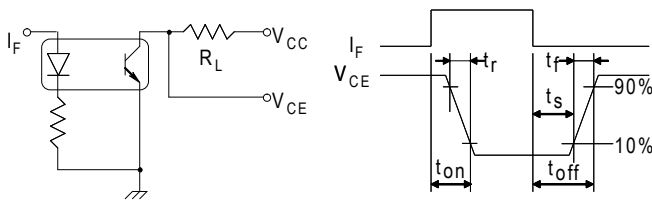

Figure 1. Switching Time Test Circuit

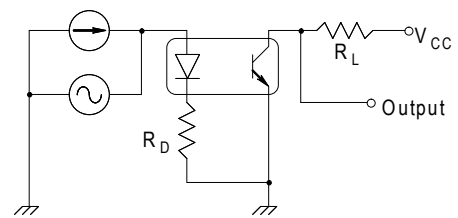

Figure 2. Frequency Response Test Circuit

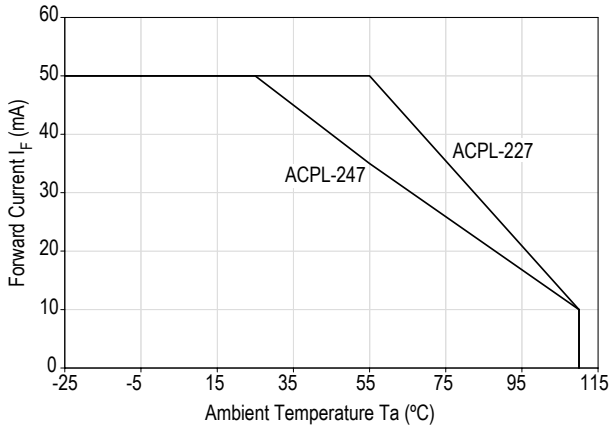

Figure 3. Forward Current vs. Ambient Temperature.

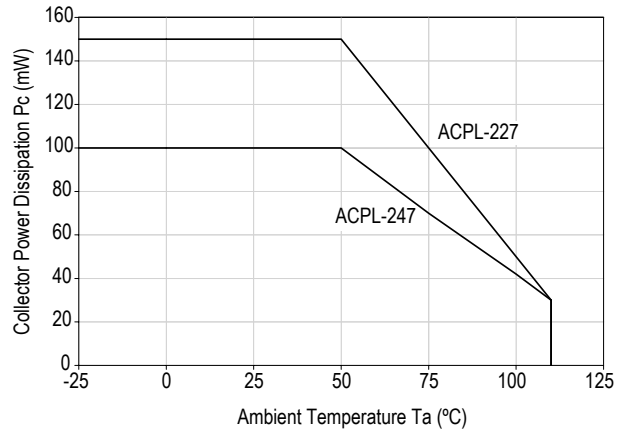

Figure 4. Collector Power Dissipation vs. Ambient Temperature

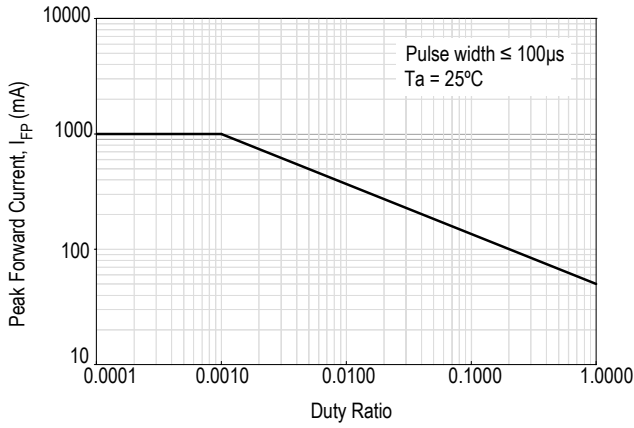

Figure 5. Pulse Forward Current vs. Duty Cycle Ratio

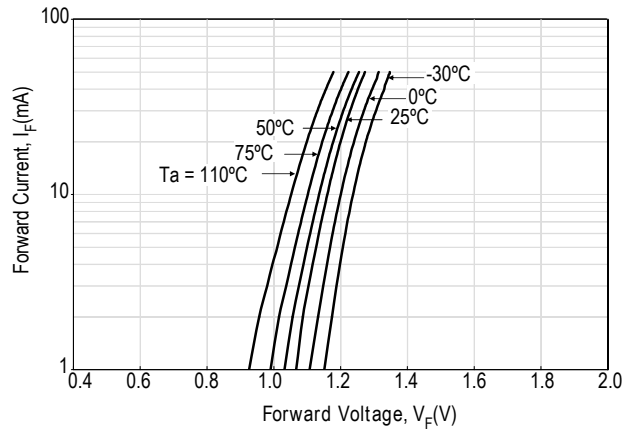

Figure 6. Forward Current vs. Forward Voltage

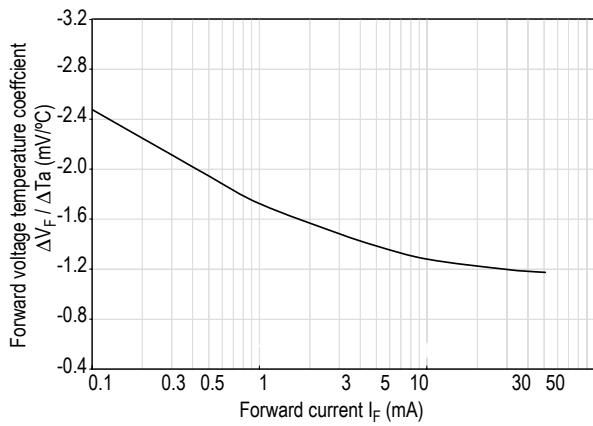

Figure 7. Forward Voltage Temperature Coefficient vs. Forward Current

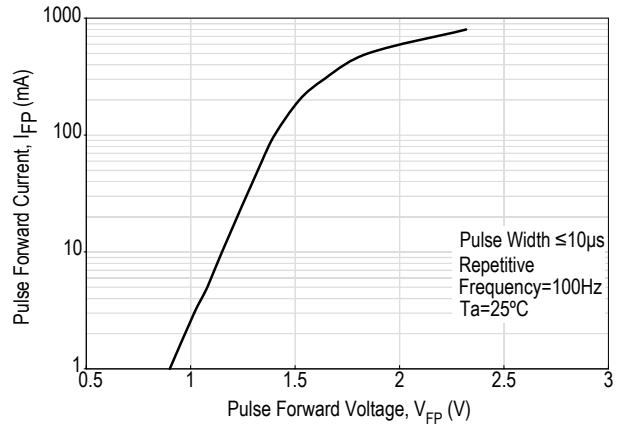

Figure 8. Pulse Forward Current vs. Pulse Forward Voltage

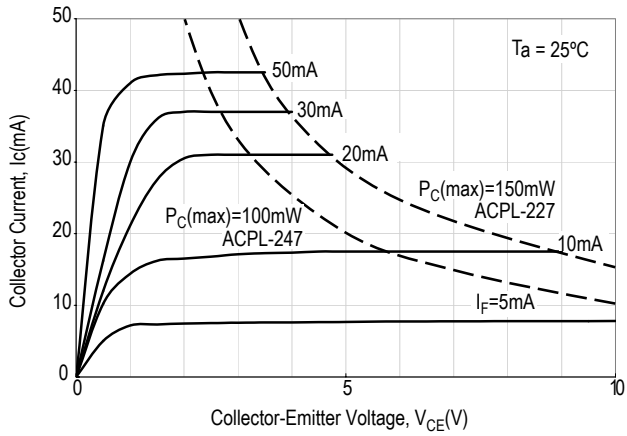

Figure 9. Collector Current vs. Collector-Emitter Voltage

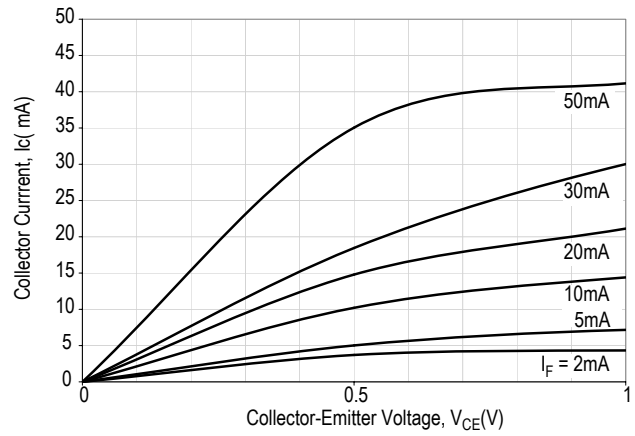

Figure 10. Collector Current vs. Small Collector-Emitter Voltage

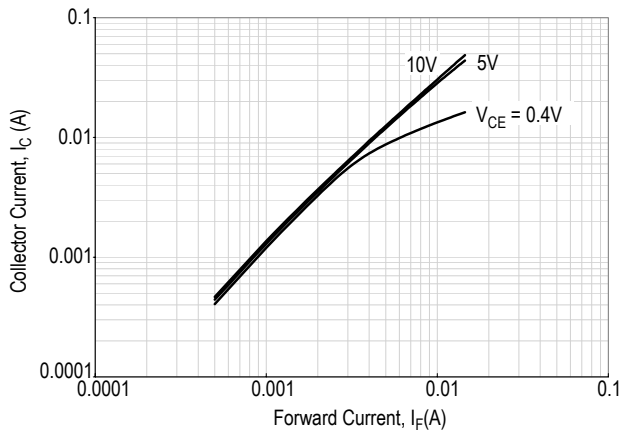

Figure 11. Collector Current vs. Forward Current

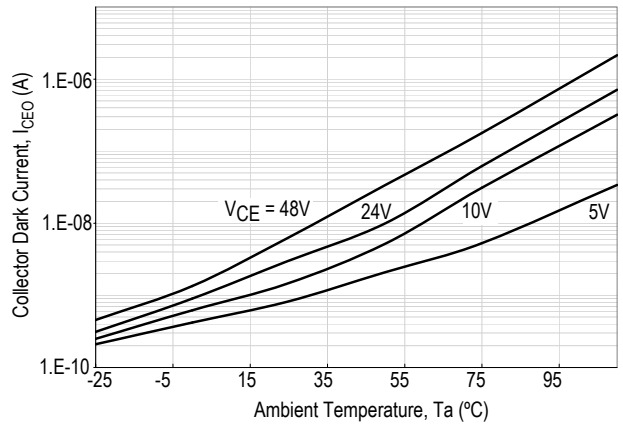

Figure 12. Collector Dark Current vs. Ambient Temperature

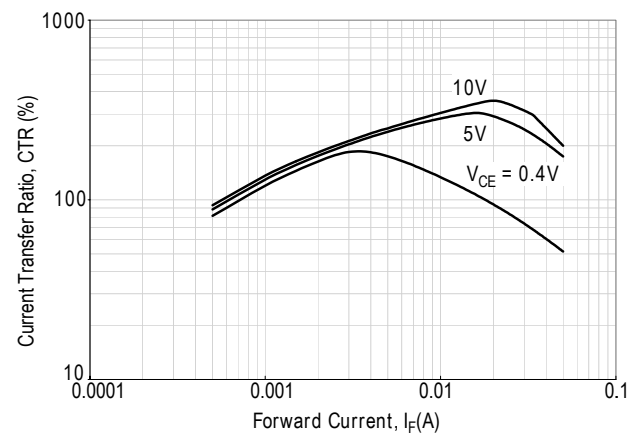

Figure 13. Current Transfer Ratio vs. Forward Current

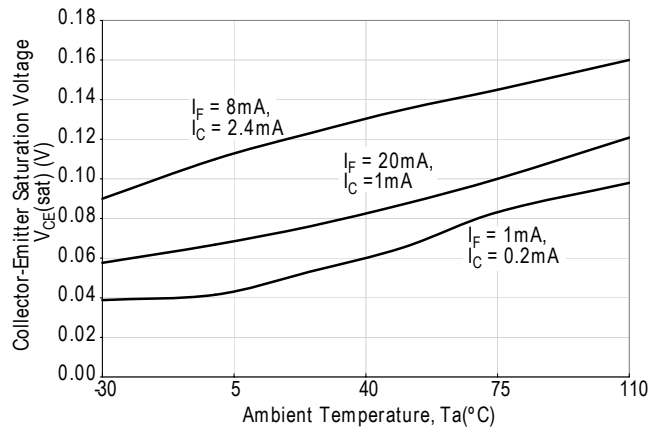

Figure 14. Collector-Emitter Saturation Voltage vs. Ambient Temperature

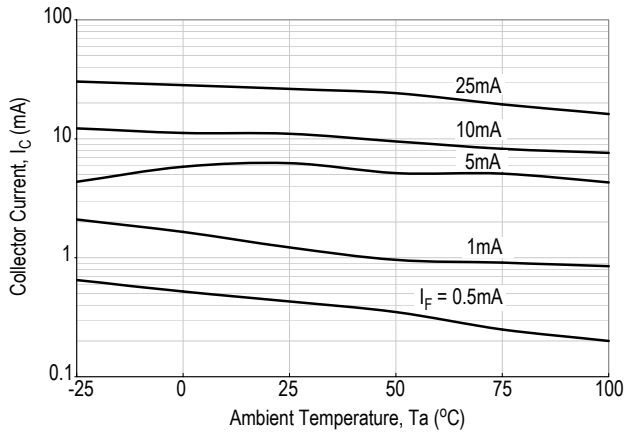

Figure 15. Collector Current vs. Ambient Temperature

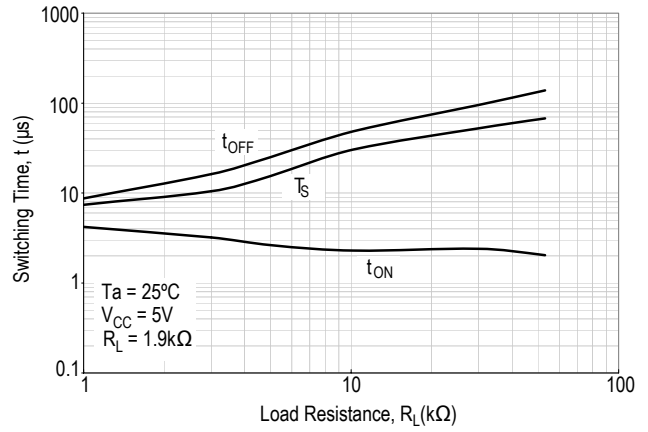

Figure 16. Switching Time vs. Load Resistance

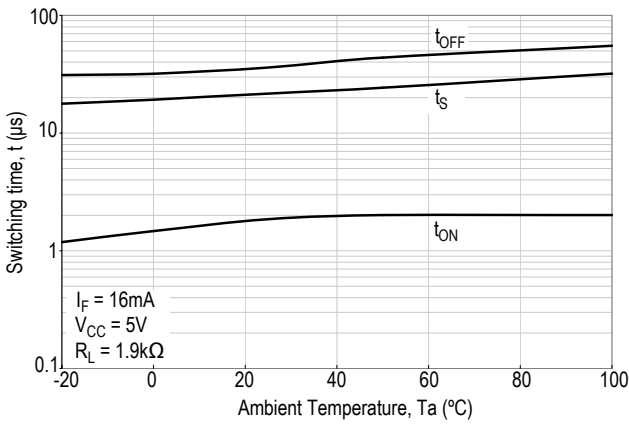

Figure 17. Switching Time vs. Ambient Temperature

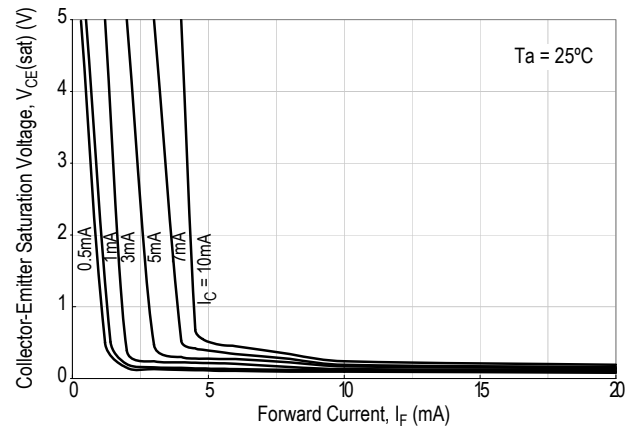

Figure 18. Collector-Emitter Saturation Voltage vs. Forward Current

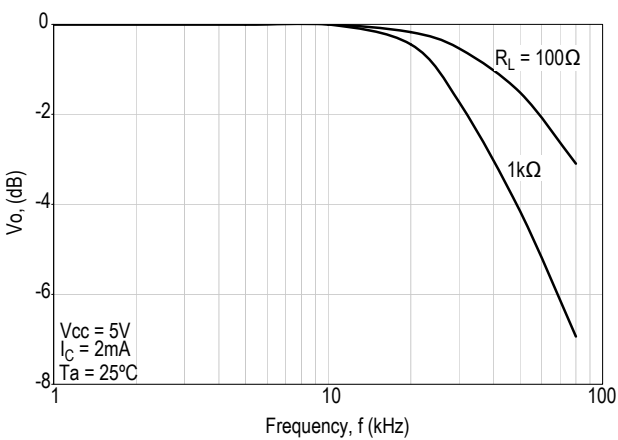

Figure 19. Frequency Response

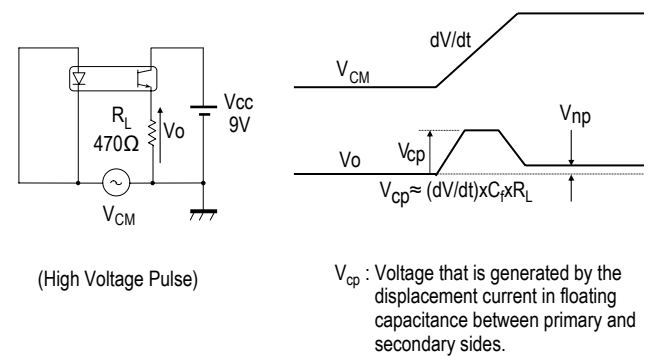

Figure 20. CMR Test Circuit



For product information and a complete list of distributors, please go to our web site: [www.avagotech.com](http://www.avagotech.com)

Avago, Avago Technologies, and the A logo are trademarks of Avago Technologies in the United States and other countries.  
Data subject to change. Copyright © 2005-2009 Avago Technologies. All rights reserved.  
AV02-0739EN - June 9, 2009

