

**General Description**

The AO4430 uses advanced trench technology to provide excellent  $R_{DS(ON)}$ , shoot-through immunity, body diode characteristics and ultra-low gate resistance. This device is ideally suited for use as a low side switch in Notebook CPU core power conversion.

RoHS and Halogen-Free Compliant

**Product Summary**

$V_{DS}$  (V) = 30V  
 $I_D$  = 18A ( $V_{GS}$  = 10V)  
 $R_{DS(ON)}$  < 5.5m $\Omega$  ( $V_{GS}$  = 10V)  
 $R_{DS(ON)}$  < 7.5m $\Omega$  ( $V_{GS}$  = 4.5V)

100% UIS Tested  
 100% Rg Tested

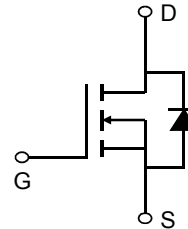
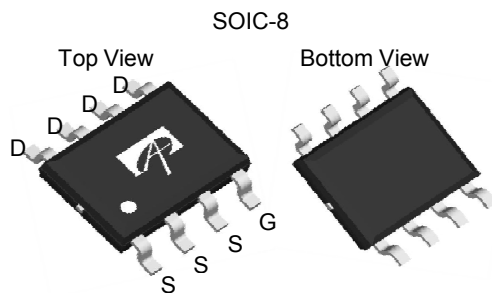
**Absolute Maximum Ratings  $T_A=25^\circ\text{C}$  unless otherwise noted**

Parameter	Symbol	Maximum	Units
Drain-Source Voltage	$V_{DS}$	30	V
Gate-Source Voltage	$V_{GS}$	$\pm 20$	V
Continuous Drain Current <sup>AF</sup>	$I_D$	$T_A=25^\circ\text{C}$	A
		$T_A=70^\circ\text{C}$	
Pulsed Drain Current <sup>B</sup>	$I_{DM}$	80	
Power Dissipation	$P_D$	$T_A=25^\circ\text{C}$	W
		$T_A=70^\circ\text{C}$	
Avalanche Current <sup>B</sup>	$I_{AR}$	30	A
Repetitive avalanche energy 0.3mH <sup>B</sup>	$E_{AR}$	135	mJ
Junction and Storage Temperature Range	$T_J, T_{STG}$	-55 to 150	$^\circ\text{C}$

**Thermal Characteristics**

Parameter	Symbol	Typ	Max	Units
Maximum Junction-to-Ambient <sup>A</sup>	$R_{\theta JA}$	31	40	$^\circ\text{C/W}$
$t \leq 10\text{s}$				
Maximum Junction-to-Ambient <sup>A</sup>	$R_{\theta JL}$	16	24	$^\circ\text{C/W}$
Steady-State				
Maximum Junction-to-Lead <sup>C</sup>				

**Electrical Characteristics (T<sub>J</sub>=25°C unless otherwise noted)**

Symbol	Parameter	Conditions	Min	Typ	Max	Units
<b>STATIC PARAMETERS</b>						
BV <sub>DSS</sub>	Drain-Source Breakdown Voltage	I <sub>D</sub> =250μA, V <sub>GS</sub> =0V	30			V
I <sub>DSS</sub>	Zero Gate Voltage Drain Current	V <sub>DS</sub> =30V, V <sub>GS</sub> =0V T <sub>J</sub> =55°C			1 5	μA
I <sub>GSS</sub>	Gate-Body leakage current	V <sub>DS</sub> =0V, V <sub>GS</sub> = ±20V			100	nA
V <sub>GS(th)</sub>	Gate Threshold Voltage	V <sub>DS</sub> =V <sub>GS</sub> I <sub>D</sub> =250μA	1	1.8	2.5	V
I <sub>D(ON)</sub>	On state drain current	V <sub>GS</sub> =4.5V, V <sub>DS</sub> =5V	80			A
R <sub>DS(ON)</sub>	Static Drain-Source On-Resistance	V <sub>GS</sub> =10V, I <sub>D</sub> =18A T <sub>J</sub> =125°C		4.7	5.5	mΩ
		V <sub>GS</sub> =4.5V, I <sub>D</sub> =15A		6.2	7.5	
g <sub>FS</sub>	Forward Transconductance	V <sub>DS</sub> =5V, I <sub>D</sub> =18A		82		S
V <sub>SD</sub>	Diode Forward Voltage	I <sub>S</sub> =1A, V <sub>GS</sub> =0V		0.7	1	V
I <sub>S</sub>	Maximum Body-Diode Continuous Current				4.5	A
<b>DYNAMIC PARAMETERS</b>						
C <sub>iss</sub>	Input Capacitance	V <sub>GS</sub> =0V, V <sub>DS</sub> =15V, f=1MHz	4660	6060	7270	pF
C <sub>oss</sub>	Output Capacitance		425	638	960	pF
C <sub>rss</sub>	Reverse Transfer Capacitance		240	355	530	pF
R <sub>g</sub>	Gate resistance	V <sub>GS</sub> =0V, V <sub>DS</sub> =0V, f=1MHz	0.2	0.45	0.9	Ω
<b>SWITCHING PARAMETERS</b>						
Q <sub>g(10V)</sub>	Total Gate Charge	V <sub>GS</sub> =10V, V <sub>DS</sub> =15V, I <sub>D</sub> =18A	80	103	124	nC
Q <sub>g(4.5V)</sub>	Total Gate Charge		37	48	58	nC
Q <sub>gs</sub>	Gate Source Charge			18		nC
Q <sub>gd</sub>	Gate Drain Charge			15		nC
t <sub>D(on)</sub>	Turn-On Delay Time	V <sub>GS</sub> =10V, V <sub>DS</sub> =15V, R <sub>L</sub> =0.83Ω, R <sub>GEN</sub> =3Ω		12	16	ns
t <sub>r</sub>	Turn-On Rise Time			8	12	ns
t <sub>D(off)</sub>	Turn-Off Delay Time			51.5	70	ns
t <sub>f</sub>	Turn-Off Fall Time			8.8	14	ns
t <sub>rr</sub>	Body Diode Reverse Recovery Time	I <sub>F</sub> =18A, dI/dt=100A/μs		33.5	44	ns
Q <sub>rr</sub>	Body Diode Reverse Recovery Charge	I <sub>F</sub> =18A, dI/dt=100A/μs		22	30	nC

A: The value of R<sub>θJA</sub> is measured with the device mounted on 1 in 2 FR-4 board with 2oz. Copper, in a still air environment with T<sub>A</sub>=25° C. The value in any given application depends on the user's specific board design.

B: Repetitive rating, pulse width limited by junction temperature.

C: The R<sub>θJA</sub> is the sum of the thermal impedance from junction to lead R<sub>θJL</sub> and lead to ambient.

D: The static characteristics in Figures 1 to 6 are obtained using <300 μs pulses, duty cycle 0.5% max.

E: These tests are performed with the device mounted on 1 in 2 FR-4 board with 2oz. Copper, in a still air environment with T<sub>A</sub>=25° C. The SOA curve provides a single pulse rating.

F: The current rating is based on the t ≤ 10s junction to ambient thermal resistance rating.

THIS PRODUCT HAS BEEN DESIGNED AND QUALIFIED FOR THE CONSUMER MARKET. APPLICATIONS OR USES AS CRITICAL COMPONENTS IN LIFE SUPPORT DEVICES OR SYSTEMS ARE NOT AUTHORIZED. AOS DOES NOT ASSUME ANY LIABILITY ARISING OUT OF SUCH APPLICATIONS OR USES OF ITS PRODUCTS. AOS RESERVES THE RIGHT TO IMPROVE PRODUCT DESIGN, FUNCTIONS AND RELIABILITY WITHOUT NOTICE.

**TYPICAL ELECTRICAL AND THERMAL CHARACTERISTICS**

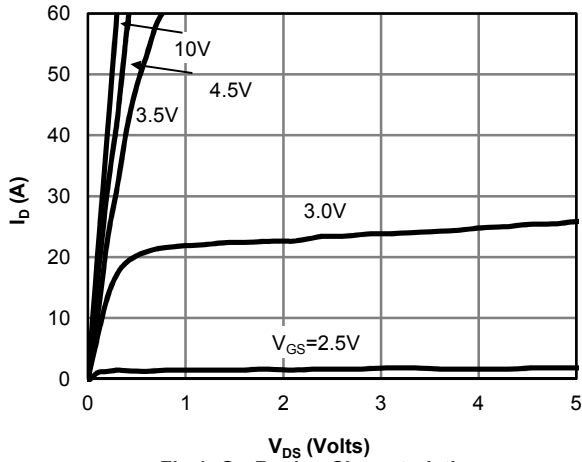

**Fig 1: On-Region Characteristics**

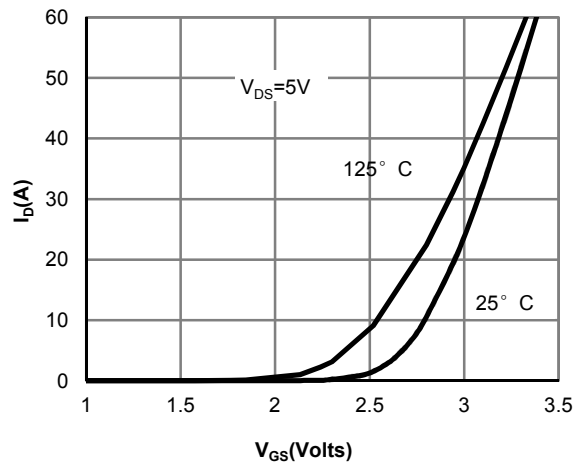

**Figure 2: Transfer Characteristics**

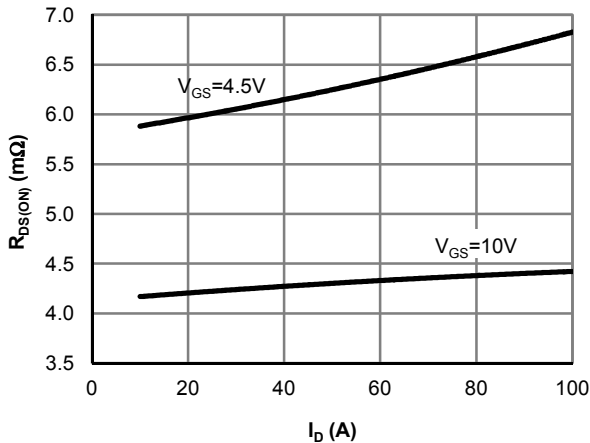

**Figure 3: On-Resistance vs. Drain Current and Gate Voltage**

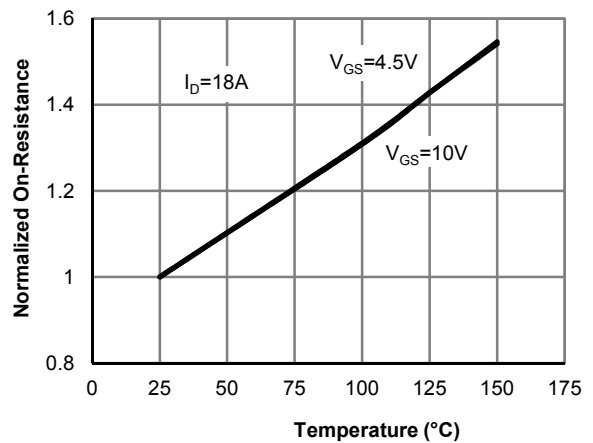

**Figure 4: On-Resistance vs. Junction Temperature**

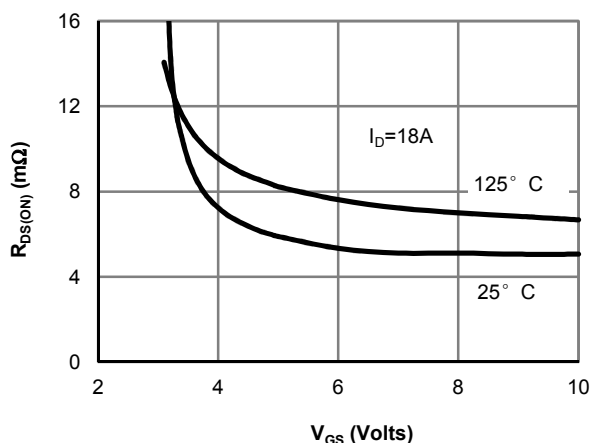

**Figure 5: On-Resistance vs. Gate-Source Voltage**

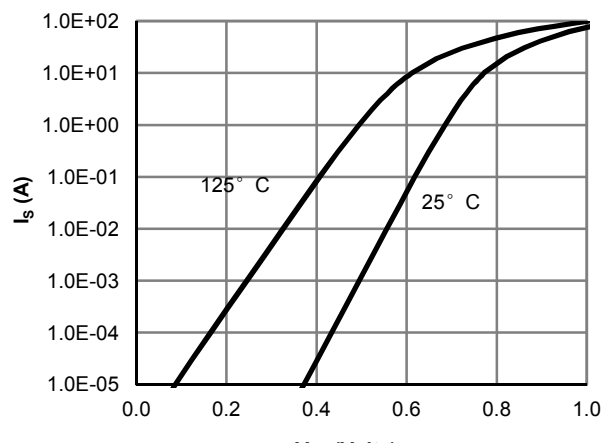

**Figure 6: Body-Diode Characteristics**

**TYPICAL ELECTRICAL AND THERMAL CHARACTERISTICS**

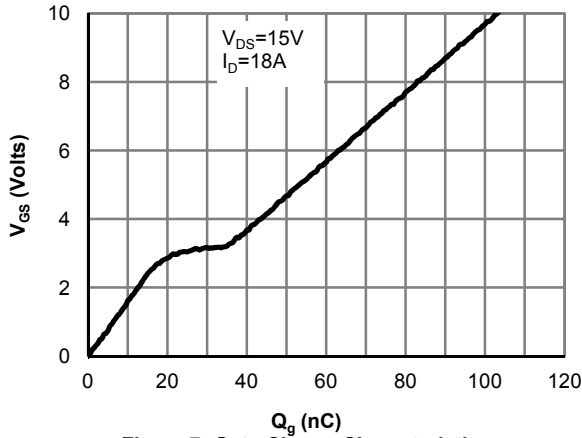

Figure 7: Gate-Charge Characteristics

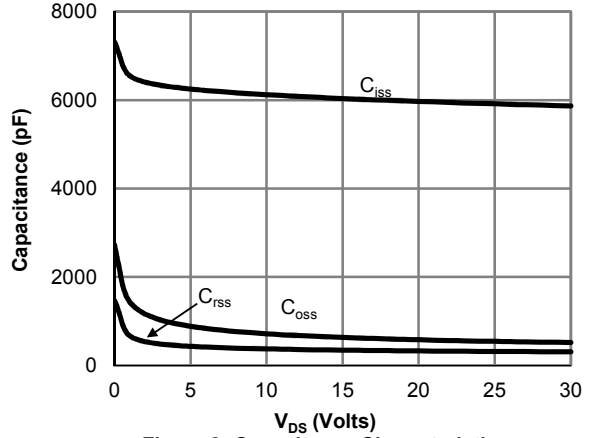

Figure 8: Capacitance Characteristics

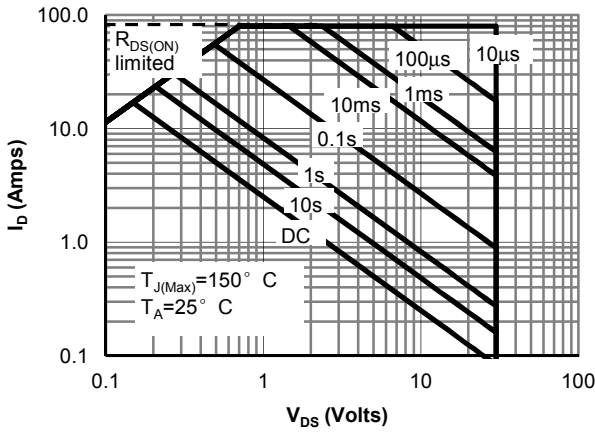

Figure 9: Maximum Forward Biased Safe Operating Area (Note E)

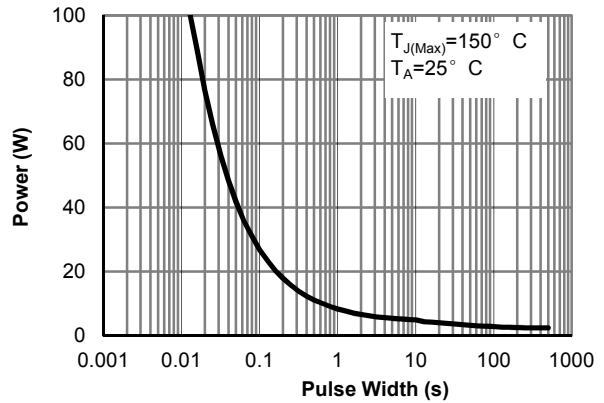

Figure 10: Single Pulse Power Rating Junction-to-Ambient (Note E)

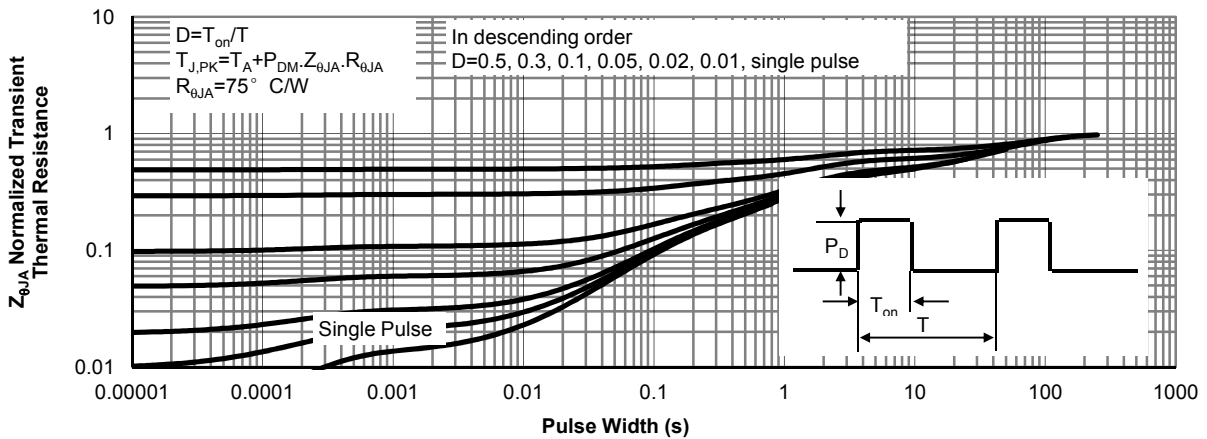
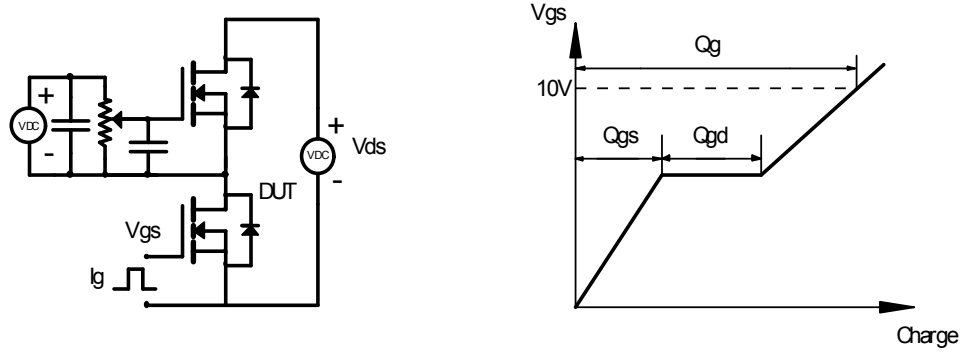
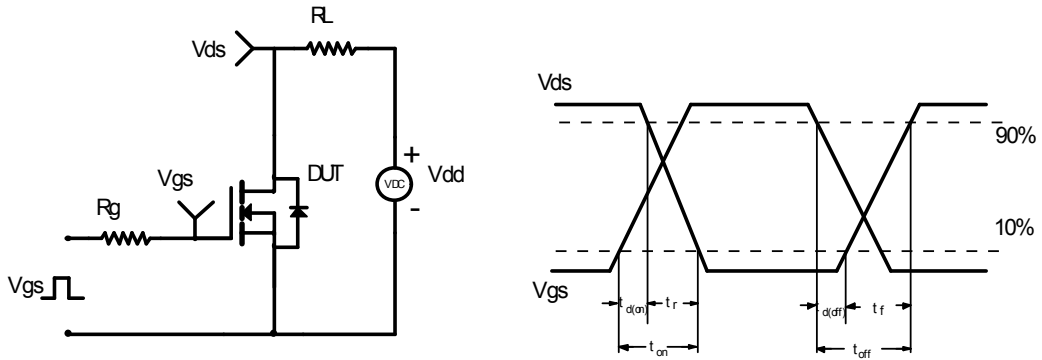

Figure 11: Normalized Maximum Transient Thermal Impedance

Gate Charge Test Circuit & Waveform



Resistive Switching Test Circuit & Waveforms



Unclamped Inductive Switching (UIS) Test Circuit & Waveforms

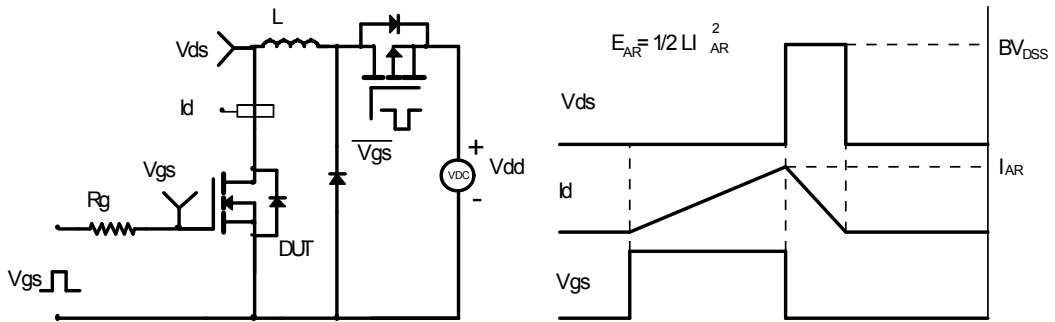

Diode Recovery Test Circuit & Waveforms

