

## 150mA Low Supply Current Low Dropout Regulator

### Description

The FP6182 is a 150mA low dropout regulator. This product is specifically designed to provide ultra low quiescent current and high output voltage accuracy.

The FP6182 integrates many functions. The current limit functions protect the device against current over-loads. It can control other converter for power sequence. The FP6182 can be enabled by other power system. Pulling and holding the EN pin below 0.4V shuts off the output.

The FP6182 is available in SOT-23-5 and UTDFN-4L (1mmx1mm) packages which features small size.

### Features

- Low Iq, Typ. 1µA No-Load Supply Current
- Supply Current in Shutdown Mode 0.1µA
- Input Voltage Range : 2.7V to 5.5V
- Output Current Limit Protection
- Dropout Voltage is 250mV @ 150mA Load
- Max. ± 1.5% Output Voltage Accuracy
- Stable with Low Cost Ceramic Capacitors
- Short-Circuit Protection
- SOT23-5 and UTDFN-4L(1mmx1mm) Packages

### Applications

- Smart Watch
- Wireless Mouse
- Wireless Sensor Networks
- Unmanned Aircraft
- Data Recorder
- IP Cam
- Dual Band Working Modes Radio

### Pin Assignment

#### S5 Package (SOT-23-5)

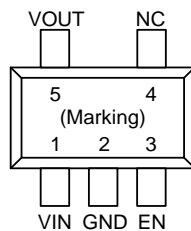

#### X6 Package (UTDFN-4L)(1mmx1mm) (Top view)

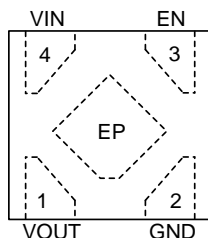
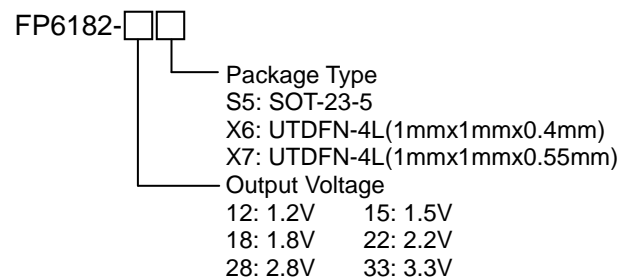

Figure 1. Pin Assignment of FP6182

### Ordering Information



Note: Please consult Fitipower sales office or authorized distributors for availability of special output voltages.

Marking Information

Part Number	Product Code	Part Number	Product Code
FP6182-12S5	FT6	FP6182-22X7	ZJ
FP6182-15S5	FT7	FP6182-28X7	ZK
FP6182-18S5	FT8	FP6182-33X7	ZL
FP6182-28S5	FT1	FP6182-12X6	ZB
FP6182-33S5	FT9	FP6182-15X6	ZC
FP6182-12X7	ZF	FP6182-18X6	ZD
FP6182-15X7	ZG	FP6182-28X6	ZA
FP6182-18X7	ZH	FP6182-33X6	ZE

Typical Application Circuit

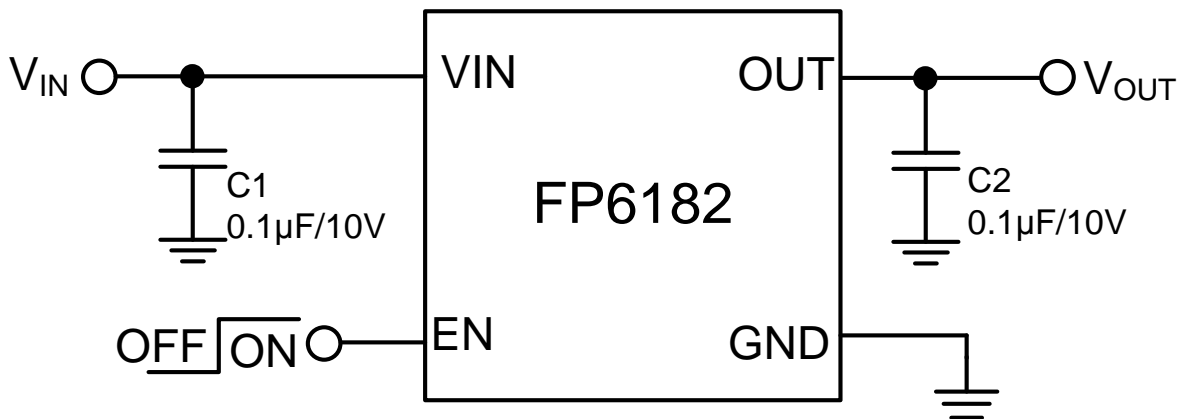

Figure 2. Typical application circuit

## Functional Pin Description

Pin Name	Pin No. (SOT-23-5)	Pin No. (UTDFN-4L)	Pin Function
VIN	1	4	Input pin. MOSFET power supply pin.
GND	2	2	Ground pin. Connect GND to exposed pad.
EN	3	3	On/Off control input. Drive EN above 1V to turn the device on, and drive EN below 0.4V to turn the device off.
NC	4	--	No connection.
VOUT	5	1	Output pin. Regulated voltage output.

## Block Diagram

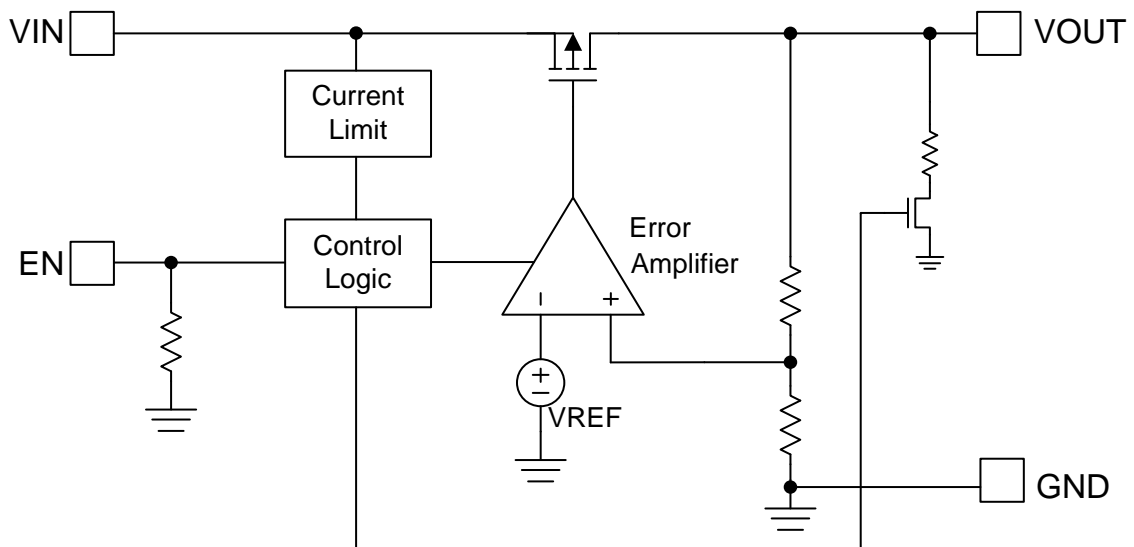

Figure 3. Block Diagram of FP6182

## Absolute Maximum Ratings <sup>(Note 1)</sup>

- Supply Voltage  $V_{IN}$  ----- -0.3V to +6V
- EN Voltage  $V_{EN}$  ----- -0.3V to  $V_{IN}+0.3V$
- Power Dissipation @  $T_A=25^{\circ}C$  &  $T_J=125^{\circ}C$  ( $P_D$ )
  - SOT23-5 ----- 0.4W
  - UTDFN-4L(1mmx1mm)----- 0.4W
- Package Thermal Resistance ( $\theta_{JA}$ ) <sup>(Note 2)</sup>
  - SOT23-5 ----- +250°C/W
  - UTDFN-4L(1mmx1mm)----- +195°C/W
- Package Thermal Resistance ( $\theta_{JC}$ )
  - SOT23-5 ----- +130°C/W
  - UTDFN-4L(1mmx1mm)----- +65°C/W
- Lead Temperature (Soldering, 10sec.) ----- 260°C
- Junction Temperature ( $T_J$ ) ----- -40°C to +150°C
- Storage Temperature ( $T_{STG}$ ) ----- -65°C to +150°C

Note 1 : Stresses beyond this listed under “Absolute Maximum Ratings” may cause permanent damage to the device.

Note 2 :  $\theta_{JA}$  is measured at 25°C ambient with the component mounted on a high effective thermal conductivity 4-layer board of JEDEC-51-7. The thermal resistance greatly varies with layout, copper thickness, number of layers and PCB size.

## Recommended Operating Conditions

- VIN Supply Voltage ----- +2.7V to +5.5V
- Output Current ( $I_{OUT}$ ) ----- 0A to 150mA
- Operating Temperature Range ( $T_{OPR}$ ) ----- -40°C to +85°C
- Operating Junction Temperature Range ( $T_J$ ) ----- -40°C to +125°C

## Electrical Characteristics

$V_{IN} = V_{OUT} + 1V$ ,  $V_{EN} = V_{IN}$ ,  $T_A = 25^\circ C$ ,  $C_{IN} = C_{OUT} = 0.1\mu F$ ,  $I_{OUT} = 1mA$ , unless otherwise specified.

Parameter	Symbol	Test Conditions	Min	Typ	Max	Units
Input Supply Voltage	$V_{IN}$		2.7		5.5	V
Quiescent Current	$I_{DDQ}$	$V_{EN} = V_{IN}$ , $I_{OUT} = 0A$		1		$\mu A$
Shutdown Current	$I_{SD}$	$V_{EN} = 0V$		0.1		$\mu A$
Output Voltage Accuracy	$\Delta V_{OUT}$	$I_{OUT} = 1mA$	-1.5		+1.5	%
Line Regulation	$\frac{\Delta V_{OUT}}{\Delta V_{IN}}$	$V_{OUT(NOM)} + 1V \leq V_{IN} \leq 5.5V$ , $I_{OUT} = 5mA$	-1		+1	%
Load Regulation	$\frac{\Delta V_{OUT}}{\Delta I_{OUT}}$	$I_{OUT} = 1mA \sim 150mA$	-2		+2	%
Output Voltage Temperature Coefficient <sup>(Note 3)</sup>	$\frac{\Delta V_{OUT}}{\Delta T_A}$	$-40^\circ C \leq T_A \leq 85^\circ C$		100		ppm/ $^\circ C$
Dropout Voltage	$V_{DROPO}$	$V_{OUT} = 1.5V$ , $I_{OUT} = 150mA$		520	800	mV
		$V_{OUT} = 1.8V$ , $I_{OUT} = 150mA$		400	600	
		$V_{OUT} = 2.8V$ , $I_{OUT} = 150mA$		280	400	
		$V_{OUT} = 3.3V$ , $I_{OUT} = 150mA$		250	350	
EN Pin Logic Threshold Voltage	$V_{ENH}$	Enable	1			V
	$V_{ENL}$	Disable			0.4	
EN Pin Current	$I_{EN}$	$V_{EN} = 2.5V$		0.3		$\mu A$
Current Limit	$I_{LIM}$	$V_{IN} = 5V$	150			mA
Current Foldback Protect	$I_{SC\_FB}$			50		mA
Output Discharge Resistance	$R_{DIS}$	$EN = 0V$		60		$\Omega$

Note 3 : Guaranteed by design

Typical Performance Curves

$V_{IN} = V_{OUT} + 1V$ ,  $V_{EN} = V_{IN}$ ,  $T_A = -40 \sim 85^\circ C$ ,  $C_{IN} = C_{OUT} = 0.1\mu F$ , unless otherwise specified.

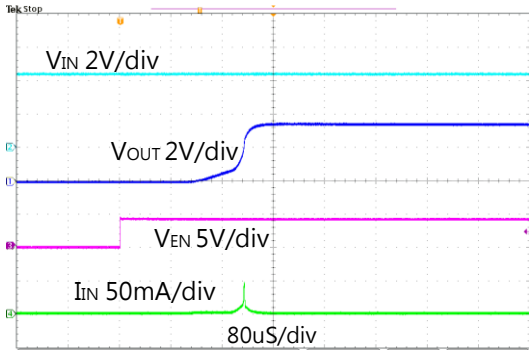

Figure 4. EN Turn On Inrush Current

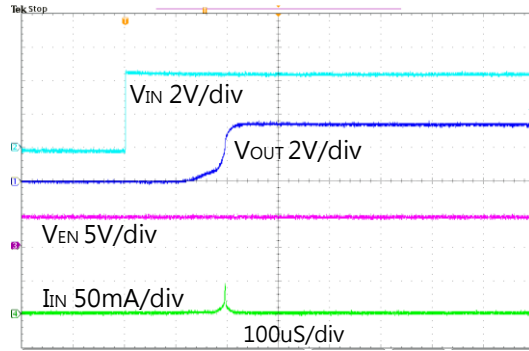

Figure 5. VIN Turn On Inrush Current

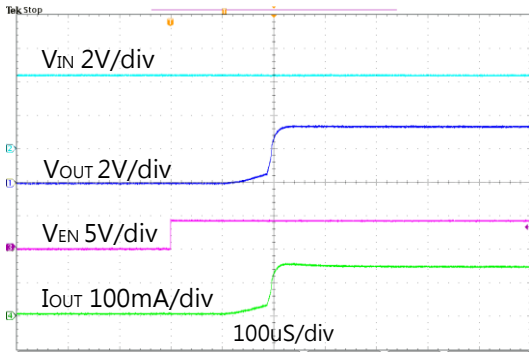

Figure 6. EN Turn On Waveform

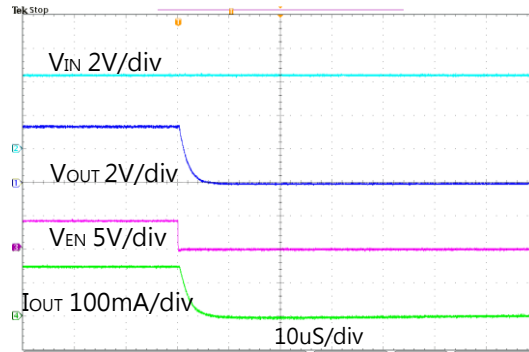

Figure 7. EN Turn OFF Waveform

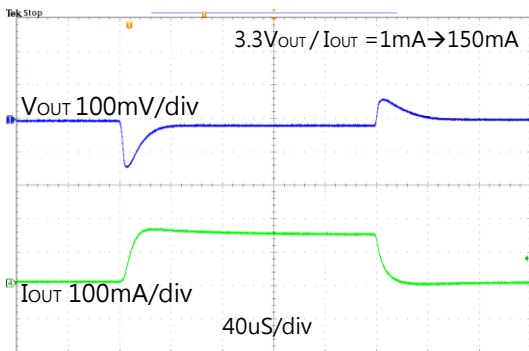

Figure 8. Load Transient Response

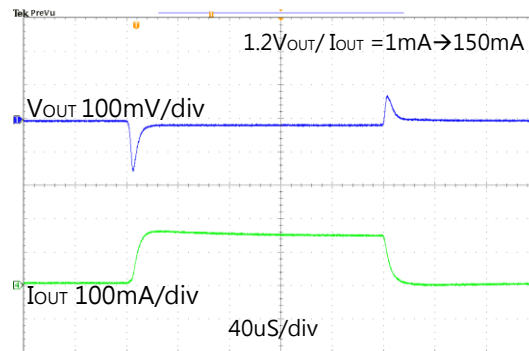

Figure 9. Load Transient Response

Typical Performance Curves (continued)

$V_{IN} = V_{OUT} + 1V$ ,  $V_{EN} = V_{IN}$ ,  $T_A = 25^\circ C$ ,  $C_{IN} = C_{OUT} = 0.1\mu F$ , unless otherwise specified.

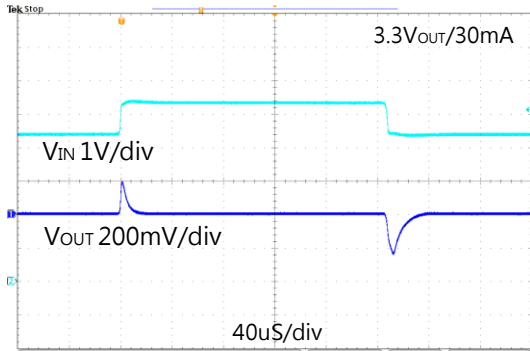

Figure 10. Line Transient Response

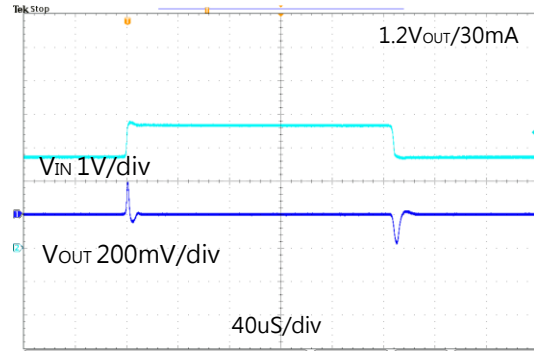

Figure 11. Line Transient Response

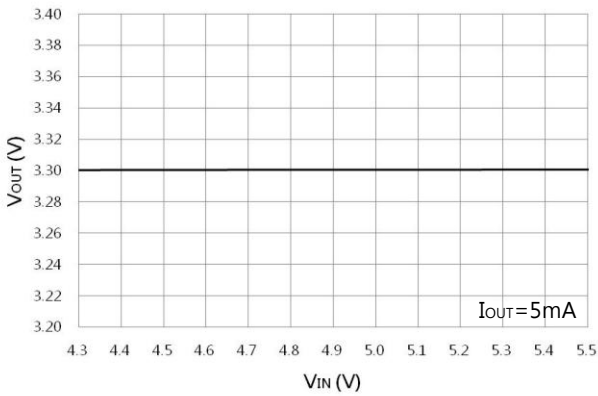

Figure 12. Output Voltage vs. Input Voltage

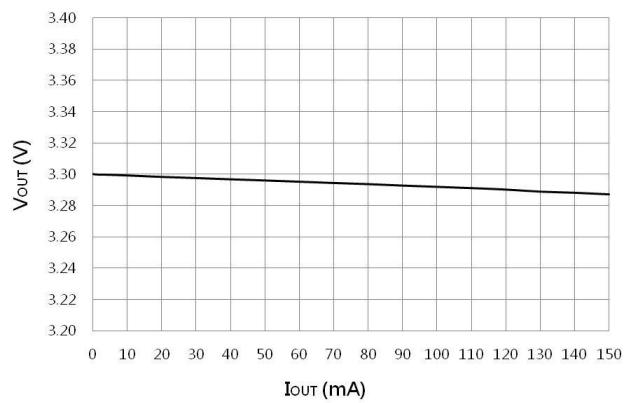

Figure 13. Output Voltage vs. Output Current

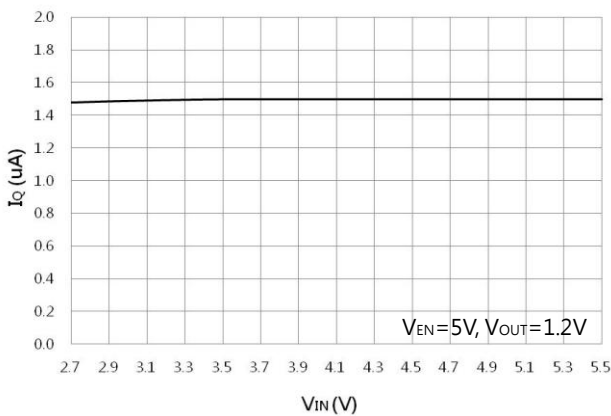

Figure 14. Quiescent Current vs. Input Voltage

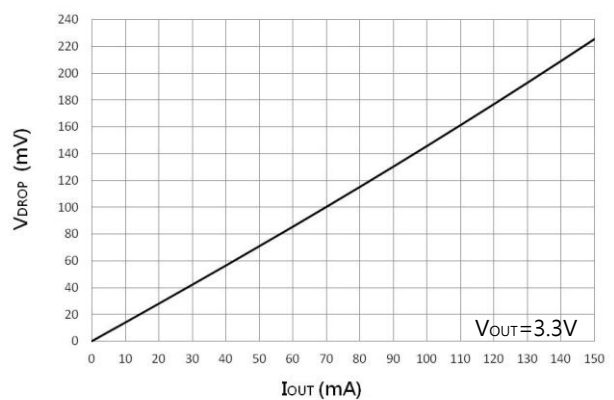

Figure 15. Dropout Voltage vs. Output Current

Typical Performance Curves (continued)

$V_{IN} = V_{OUT} + 1V$ ,  $V_{EN} = V_{IN}$ ,  $T_A = 25^\circ C$ ,  $C_{IN} = C_{OUT} = 0.1\mu F$ , unless otherwise specified.

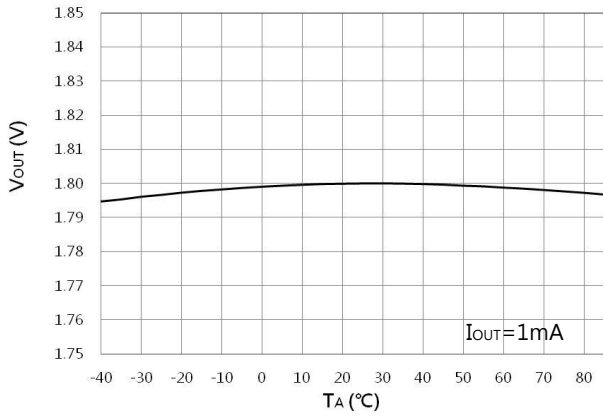

Figure 16. Output Voltage vs. Temperature

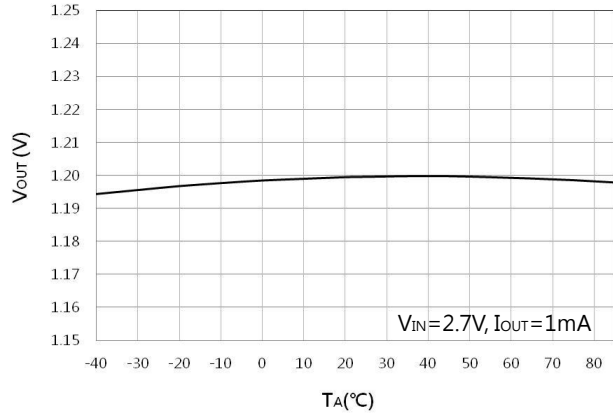

Figure 17. Output Voltage vs. Temperature

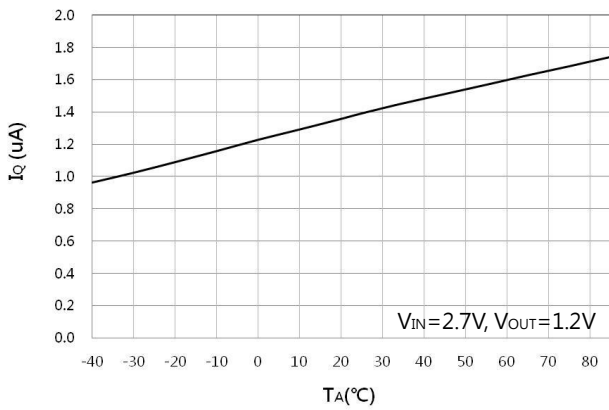

Figure 18. Quiescent Current vs. Temperature

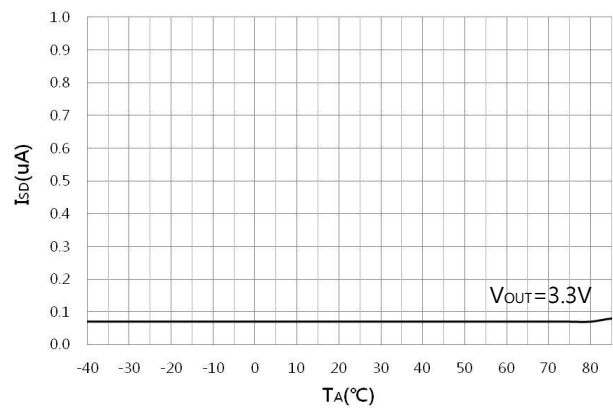

Figure 19. Shut Down Current vs. Temperature



## Application Information

The FP6182 is a 150mA low dropout regulator. This product is specifically designed to provide ultra low quiescent current and high output voltage accuracy.

### 1. Output and Input Capacitor

The FP6182 regulator is designed to be stable with a wide range of output capacitors. The ESR of the output capacitor affects stability. Larger value of the output capacitor decreases the peak deviations and improves transient response for larger current changes.

The capacitor types (aluminum, ceramic, and tantalum) have different characterizations such as temperature and voltage coefficients. All ceramic capacitors are manufactured with a variety of dielectrics, each with different behavior across temperature and applications. Common dielectrics used are X5R, X7R and Y5V. It is recommended to use 0.1 $\mu$ F to 1 $\mu$ F X5R or X7R dielectric ceramic capacitors with 30m $\Omega$  to 50m $\Omega$  ESR range between device outputs and ground for stability. The ESR of output capacitor is very important because it generates a zero to provide phase lead for loop stability.

There are no requirements for the ESR on the input capacitor, but its voltage and temperature coefficient have to be considered for device application environment.

### 2. Protection Features

In order to prevent overloading from damaging the device, FP6182 has internal current limiting functions designed to protect the device.

### 3. Thermal Consideration

The power handling capability of the device will be limited by allowable operation junction temperature (125°C). The power dissipated by the device will be estimated by  $P_D = I_{OUT} \times (V_{IN} - V_{OUT})$ . The power dissipation should be lower than the maximum power dissipation listed in "Absolute Maximum Ratings" section.

### 4. Shutdown Operation

The FP6182 is shutdown by pulling the  $\overline{\text{SHDN}}$  input low, and turned on by driving the  $\overline{\text{SHDN}}$  high. If  $\overline{\text{SHDN}}$  pin floating, the FP6182 will shut down because  $\overline{\text{SHDN}}$  pin has built-in a pull low resistor (refer to Block Diagram).

Outline Information

SOT-23-5 Package (Unit: mm)

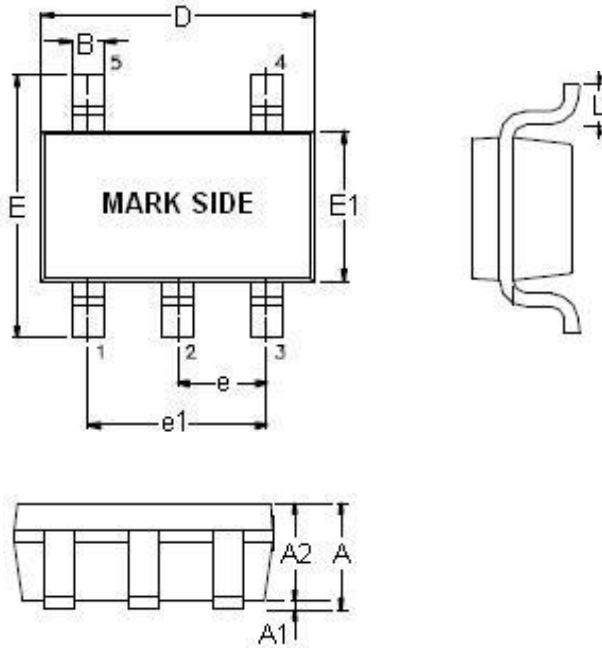

SYMBOLS UNIT	DIMENSION IN MILLIMETER	
	MIN	MAX
A	0.90	1.45
A1	0.00	0.15
A2	0.90	1.30
B	0.30	0.50
D	2.80	3.00
E	2.60	3.00
E1	1.50	1.70
e	0.90	1.00
e1	1.80	2.00
L	0.30	0.60

Note : Followed From JEDEC MO-178-C.

Carrier Dimensions

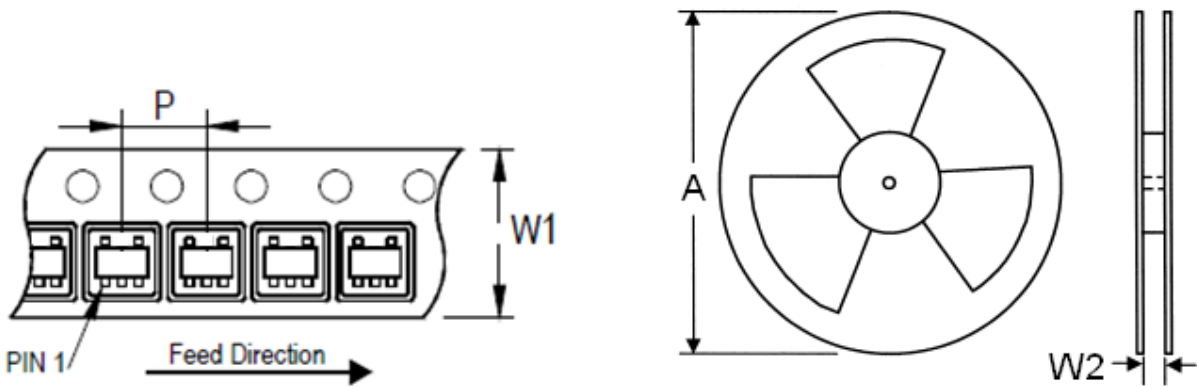

Tape Size (W1) mm	Pocket Pitch (P) mm	Reel Size (A)		Reel Width (W2) mm	Empty Cavity Length mm	Units per Reel
		in	mm			
8	4	7	180	8.4	300~1000	3,000

Outline Information (Continued)

UTDFN- 4L 1.0mm x 1.0mm (pitch 0.65 mm) Package (Unit: mm)

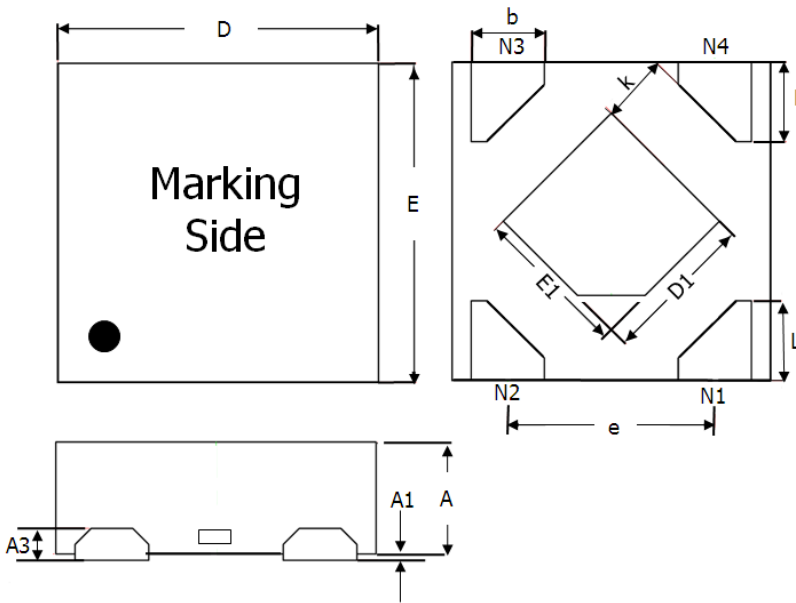

SYMBOLS UNIT	DIMENSION IN MILLIMETER	
	MIN	MAX
A	0.340	0.400
A1	0.00	0.050
A3	0.102REF	
D	0.950	1.050
E	0.950	1.050
D1	0.430	0.530
E1	0.430	0.530
k	0.211REF	
b	0.180	0.280
e	0.650TYP	
L	0.200	0.300

Note : Followed From JEDEC 664-1

Carrier Dimensions

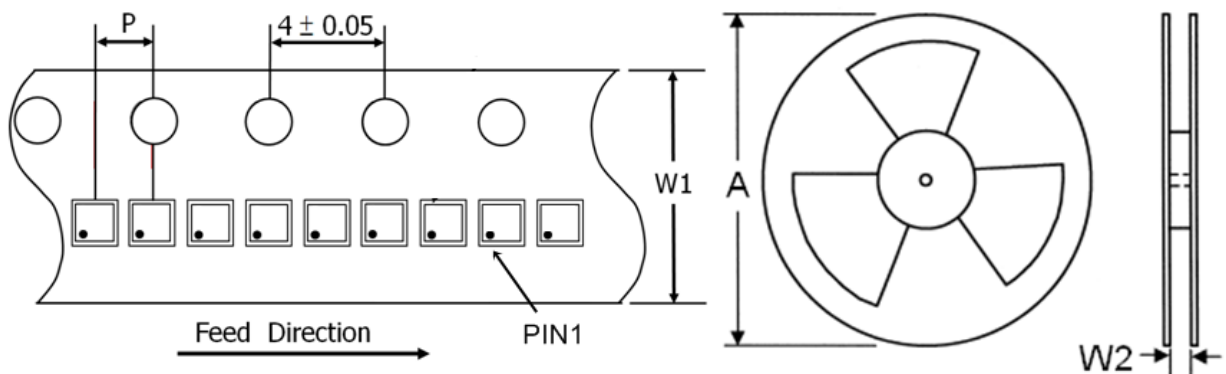

Tape Size (W1) mm	Pocket Pitch (P) mm	Reel Size (A)		Reel Width (W2) mm	Empty Cavity Length mm	Units per Reel
		in	mm			
8	2	7	180	9.5	400~1000	10,000

Outline Information (Continued)

UTDFN- 4L 1.0mm x 1.0mm (pic mm) Package (Unit: mm)

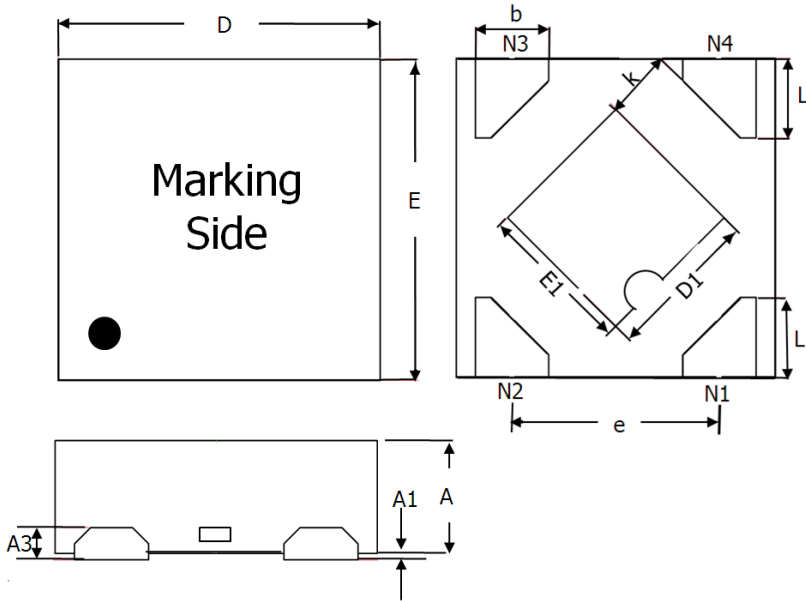

SYMBOLS UNIT	DIMENSION IN MILLIMETER	
	MIN	MAX
A	0.500	0.600
A1	0.00	0.050
A3	0.152REF.	
D	0.950	1.050
E	0.950	1.050
D1	0.450	0.550
E1	0.450	0.550
k	0.211REF.	
b	0.180	0.280
e	0.625TYP	
L	0.200	0.300

Note 1 : Followed From JEDEC 664-1

Carrier dimensions

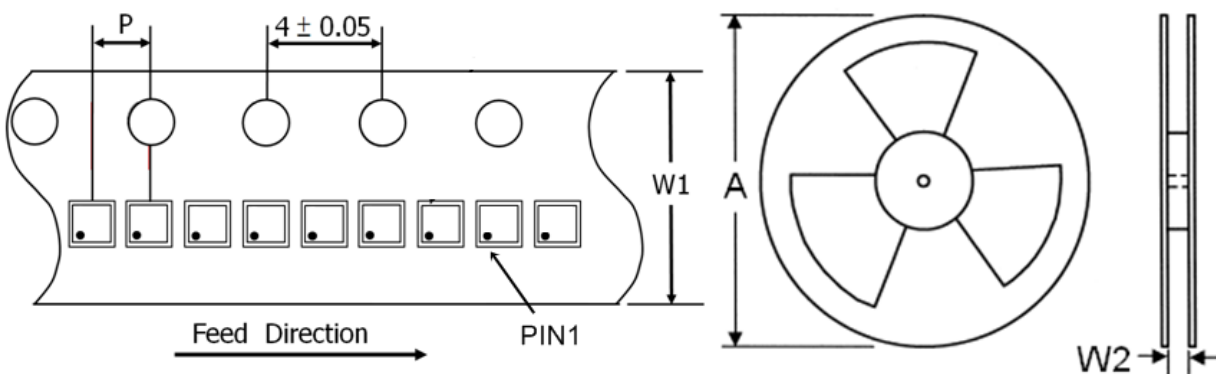

Tape Size (W1) mm	Pocket Pitch (P) mm	Reel Size (A)		Reel Width (W2) mm	Empty Cavity Length mm	Units per Reel
		in	mm			
8	2	7	180	9.5	400~1000	10,000

Life Support Policy

Fitipower's products are not authorized for use as critical components in life support devices or other medical systems.