

## 300 mA Single Output LDO in Small Packages

### Features

- Input Voltage Range: 2.5V to 5.5V
- Fixed Output Voltages from 1.0V to 3.3V
- 300 mA Guaranteed Output Current
- High Output Accuracy ( $\pm 2\%$ )
- Low Quiescent Current: 38  $\mu\text{A}$
- Stable with 1  $\mu\text{F}$  Ceramic Output Capacitors
- Low Dropout Voltage: 160 mV @ 300 mA
- Output Discharge Circuit: MIC5502, MIC5504
- Internal Enable Pull-Down: MIC5503, MIC5504
- Thermal-Shutdown and Current-Limit Protection
- 4-Lead 1.0 mm x 1.0 mm Thin DFN Package
- MIC5501/4 5-Lead SOT23 Package

### Applications

- Smartphones
- DSC, GPS, PMP, and PDAs
- Medical Devices
- Portable Electronics
- 5V Systems

### General Description

The MIC5501/2/3/4 is an advanced general-purpose LDO ideal for powering general-purpose portable devices. The MIC5501/2/3/4 family of products provides a high-performance 300 mA LDO in an ultra-small 1 mm x 1 mm package. The MIC5502 and MIC5504 LDOs include an auto-discharge feature on the output that is activated when the enable pin is low. The MIC5503 and MIC5504 have an internal pull-down resistor on the enable pin that disables the output when the enable pin is left floating. This is ideal for applications where the control signal is floating during processor boot up.

Ideal for battery-powered applications, the MIC5501/2/3/4 offers 2% initial accuracy, low dropout voltage (160 mV at 300 mA), and low ground current (typically 38  $\mu\text{A}$ ). The MIC5501/2/3/4 can also be put into a zero-off-mode current state, drawing virtually no current when disabled.

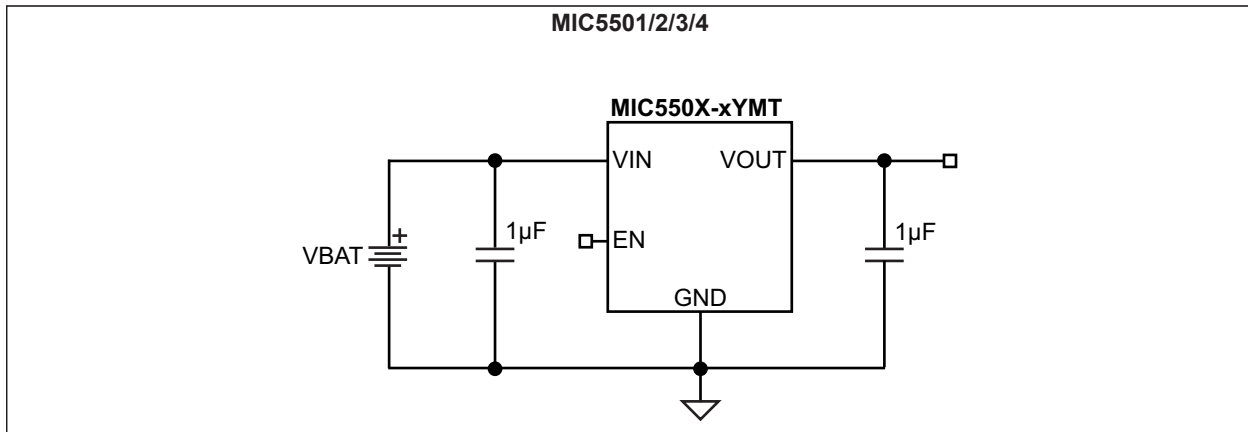
The MIC5501/2/3/4 has an operating junction temperature range of  $-40^{\circ}\text{C}$  to  $+125^{\circ}\text{C}$ .

### Package Types



# MIC5501/2/3/4

## Typical Application Circuit



## 1.0 ELECTRICAL CHARACTERISTICS

### Absolute Maximum Ratings †

Supply Voltage ( $V_{IN}$ )	.....	-0.3V to +6V
Enable Voltage ( $V_{EN}$ )	.....	-0.3V to $V_{IN}$
Power Dissipation ( $P_D$ )	.....	Internally Limited, <a href="#">Note 1</a>
ESD Rating ( <a href="#">Note 2</a> )	.....	3 kV

### Operating Ratings ‡

Supply Voltage ( $V_{IN}$ )	.....	+2.5V to +5.5V
Enable Voltage ( $V_{EN}$ )	.....	0V to $V_{IN}$

† **Notice:** Stresses above those listed under “Absolute Maximum Ratings” may cause permanent damage to the device. This is a stress rating only and functional operation of the device at those or any other conditions above those indicated in the operational sections of this specification is not intended. Exposure to maximum rating conditions for extended periods may affect device reliability.

‡ **Notice:** The device is not guaranteed to function outside its operating ratings.

**Note 1:** The maximum allowable power dissipation of any  $T_A$  (ambient temperature) is  $P_{D(max)} = (T_{J(max)} - T_A)/\theta_{JA}$ . Exceeding the maximum allowable power dissipation will result in excessive die temperature, and the regulator will go into thermal shutdown.

**2:** Devices are ESD sensitive. Handling precautions are recommended. Human body model, 1.5 k $\Omega$  in series with 100 pF.

## ELECTRICAL CHARACTERISTICS

**Electrical Characteristics:**  $V_{IN} = V_{EN} = V_{OUT} + 1V$ ;  $C_{IN} = C_{OUT} = 1 \mu F$ ;  $I_{OUT} = 100 \mu A$ ;  $T_J = +25^\circ C$ , **bold** values indicate  $-40^\circ C$  to  $+125^\circ C$ , unless noted.

Parameter	Symbol	Min.	Typ.	Max.	Units	Conditions
Output Voltage Accuracy	$V_{OUT}$	-2.0	—	2.0	%	Variation from nominal $V_{OUT}$
		<b>-3.0</b>	—	<b>3.0</b>		Variation from nominal $V_{OUT}$ ; $-40^\circ C$ to $+125^\circ C$
Line Regulation	—	—	0.02	<b>0.3</b>	%/V	$V_{IN} = V_{OUT} + 1V$ to 5.5V; $I_{OUT} = 100 \mu A$
Load Regulation ( <a href="#">Note 1</a> )	—	—	8	40	mV	$I_{OUT} = 100 \mu A$ to 300 mA
Dropout Voltage ( <a href="#">Note 2</a> )	$V_{DO}$	—	80	<b>190</b>	mV	$I_{OUT} = 150$ mA
		—	160	<b>380</b>		$I_{OUT} = 300$ mA
Ground Pin Current ( <a href="#">Note 3</a> )	$I_{GND}$	—	38	<b>55</b>	$\mu A$	$I_{OUT} = 0$ mA
		—	42	<b>65</b>		$I_{OUT} = 300$ mA
Ground Pin Current in Shutdown	$I_{GND(SHDN)}$	—	0.05	1	$\mu A$	$V_{EN} = 0V$
Ripple Rejection	PSRR	—	60	—	dB	$f = 1$ kHz; $C_{OUT} = 1 \mu F$
Current Limit	$I_{LIM}$	400	630	900	mA	$V_{OUT} = 0V$
Output Voltage Noise	$e_n$	—	175	—	$\mu V_{RMS}$	$C_{OUT} = 1 \mu F$ , 10 Hz to 100 kHz
Auto-Discharge NFET Resistance	—	—	25	—	$\Omega$	MIC5502, MIC5504 Only; $V_{EN} = 0V$ ; $V_{IN} = 3.6V$ ; $I_{OUT} = -3$ mA
<b>Enable Input</b>						
Enable Pull-Down Resistor	—	—	4	—	M $\Omega$	For MIC5503 and MIC5504 use only
Enable Input Voltage	$V_{EN}$	—	—	<b>0.2</b>	V	Logic-Low
		<b>1.2</b>	—	—		Logic-High

# MIC5501/2/3/4

## ELECTRICAL CHARACTERISTICS (CONTINUED)

**Electrical Characteristics:**  $V_{IN} = V_{EN} = V_{OUT} + 1V$ ;  $C_{IN} = C_{OUT} = 1 \mu F$ ;  $I_{OUT} = 100 \mu A$ ;  $T_J = +25^\circ C$ , **bold** values indicate  $-40^\circ C$  to  $+125^\circ C$ , unless noted.

Parameter	Symbol	Min.	Typ.	Max.	Units	Conditions
Enable Input Current MIC5501, MIC5502	$I_{EN}$	—	0.01	1	$\mu A$	$V_{EN} = 0V$
		—	0.01	1		$V_{EN} = 5.5V$
Enable Input Current MIC5503, MIC5504	$I_{EN}$	—	0.01	1	$\mu A$	$V_{EN} = 0V$
		—	1.4	2		$V_{EN} = 5.5V$
Turn-On Time	$t_{ON}$	—	50	<b>125</b>	$\mu s$	$C_{OUT} = 1 \mu F$ ; $I_{OUT} = 150 mA$

- Note 1:** Regulation is measured at constant junction temperature using low duty cycle pulse testing. Changes in output voltage due to heating effects are covered by the thermal regulation specification.
- 2:** Dropout voltage is defined as the input-to-output differential at which the output voltage drops 2% below its nominal value measured at 1V differential. For outputs below 2.5V, dropout voltage is the input-to-output differential with the minimum input voltage 2.5V.
- 3:** Ground pin current is the regulator quiescent current. The total current drawn from the source is the sum of the load current plus the ground pin current.

## TEMPERATURE SPECIFICATIONS (Note 1)

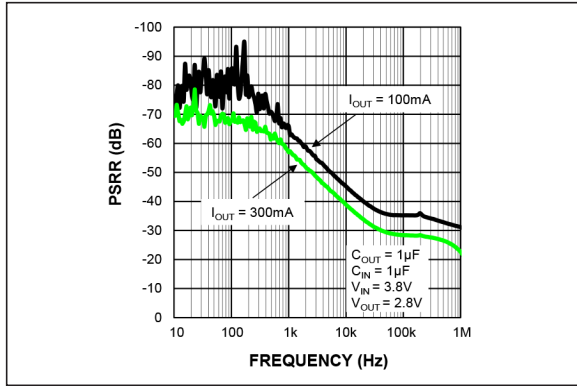
Parameters	Symbol	Min.	Typ.	Max.	Units	Conditions
<b>Temperature Ranges</b>						
Storage Temperature Range	$T_S$	-65	—	+150	°C	—
Maximum Junction Temperature Range	$T_J$	-40	—	+150	°C	—
Operating Junction Temperature Range	$T_J$	-40	—	+125	°C	—
Lead Temperature	—	—	—	+260	°C	Soldering, 10s
<b>Package Thermal Resistances</b>						
Thermal Resistance 1 mm x 1 mm Thin DFN-4	$\theta_{JA}$	—	250	—	°C/W	—
Thermal Resistance SOT23-5	$\theta_{JA}$	—	253	—	°C/W	—

**Note 1:** The maximum allowable power dissipation is a function of ambient temperature, the maximum allowable junction temperature and the thermal resistance from junction to air (i.e.,  $T_A$ ,  $T_J$ ,  $\theta_{JA}$ ). Exceeding the maximum allowable power dissipation will cause the device operating junction temperature to exceed the maximum +125°C rating. Sustained junction temperatures above +125°C can impact the device reliability.

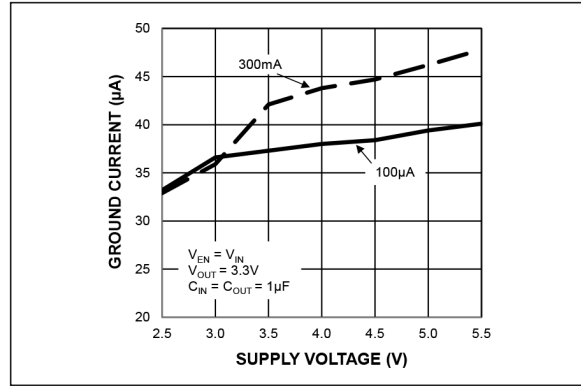
# MIC5501/2/3/4

## 2.0 TYPICAL PERFORMANCE CURVES

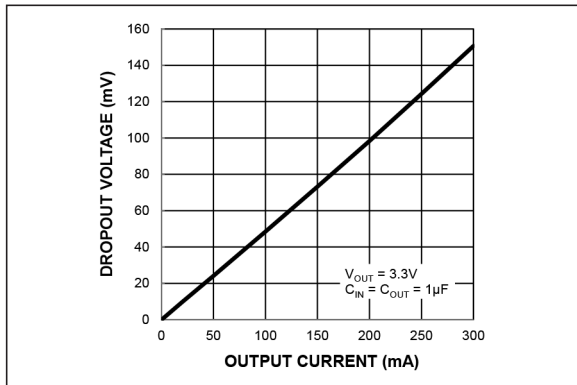
**Note:** The graphs and tables provided following this note are a statistical summary based on a limited number of samples and are provided for informational purposes only. The performance characteristics listed herein are not tested or guaranteed. In some graphs or tables, the data presented may be outside the specified operating range (e.g., outside specified power supply range) and therefore outside the warranted range.



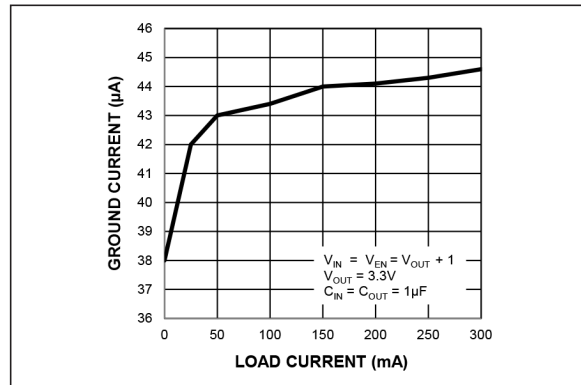
**FIGURE 2-1:** Power Supply Rejection Ratio.



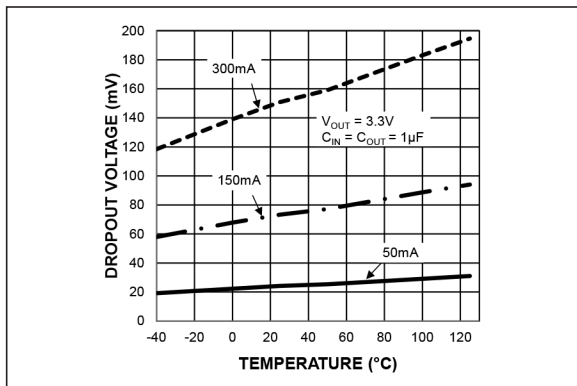
**FIGURE 2-4:** Ground Current vs. Supply Voltage.



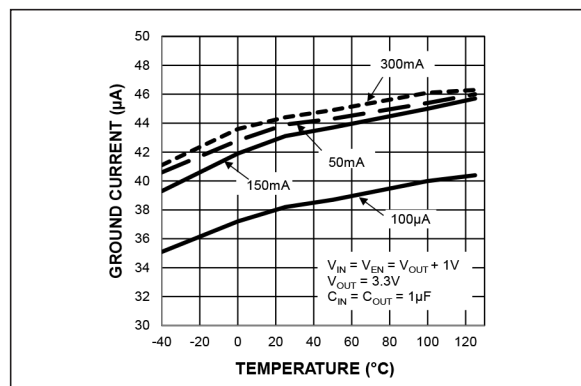
**FIGURE 2-2:** Dropout Voltage vs. Output Current.



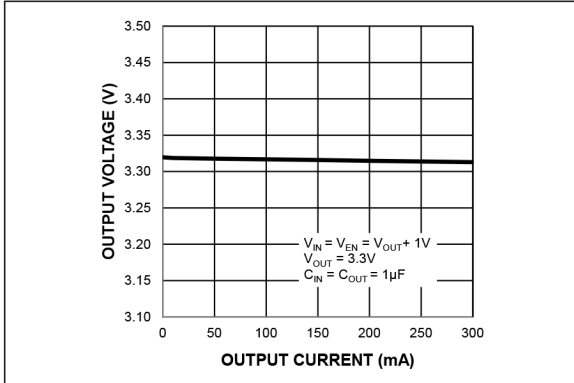
**FIGURE 2-5:** Ground Current vs. Load Current.



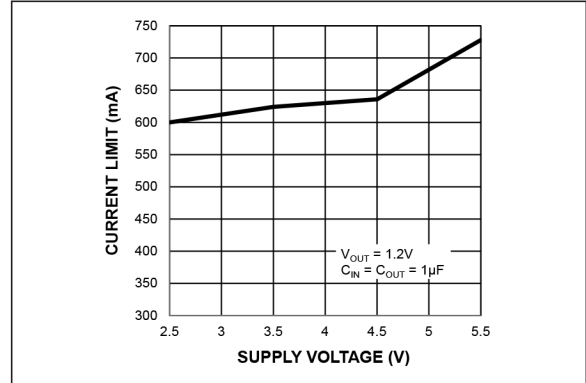
**FIGURE 2-3:** Dropout Voltage vs. Temperature.



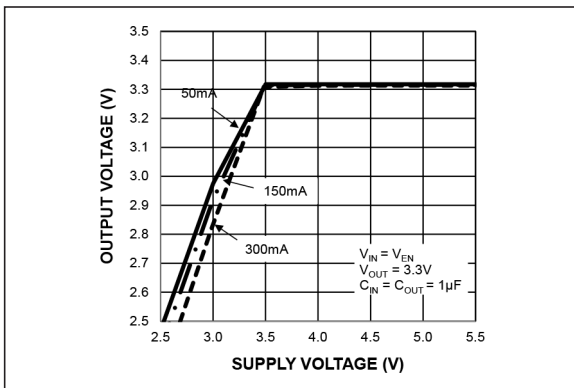
**FIGURE 2-6:** Ground Current vs. Temperature.



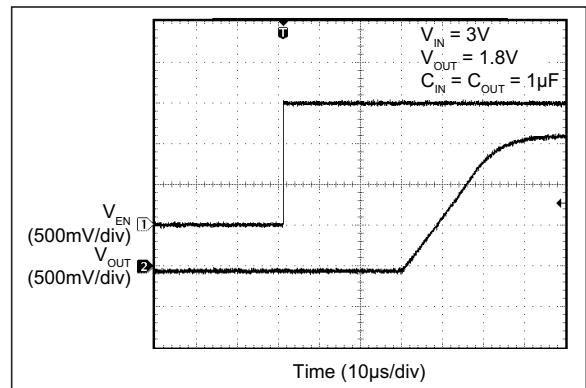
**FIGURE 2-7:** Output Voltage vs. Output Current.



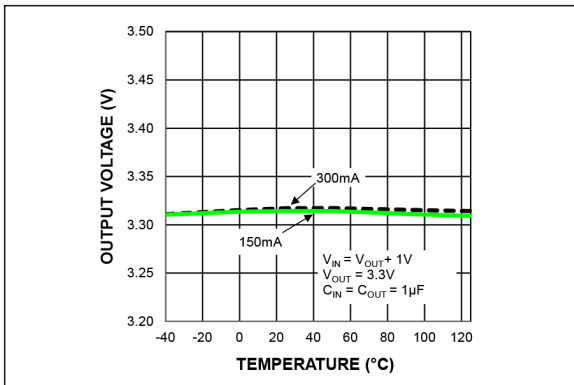
**FIGURE 2-10:** Current Limit vs. Supply Voltage.



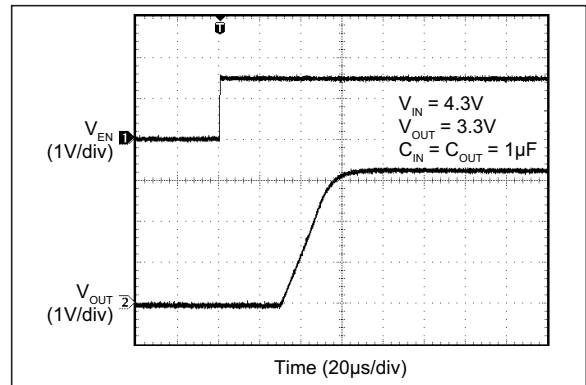
**FIGURE 2-8:** Output Voltage vs. Supply Voltage.



**FIGURE 2-11:** Enable Turn-On.

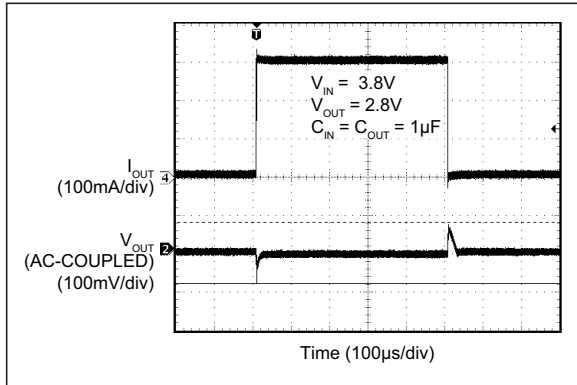


**FIGURE 2-9:** Output Voltage vs. Temperature.

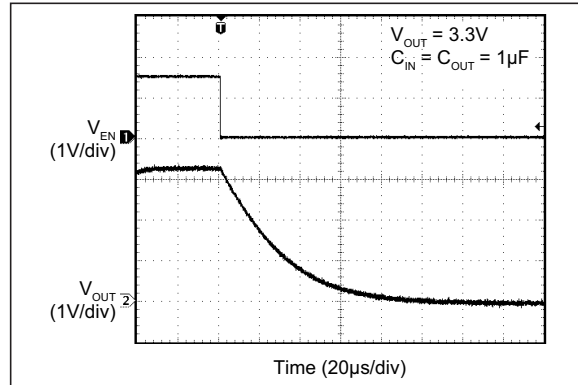


**FIGURE 2-12:** Enable Turn-On.

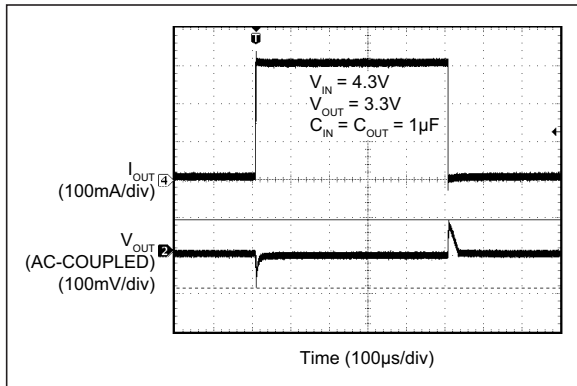
# MIC5501/2/3/4



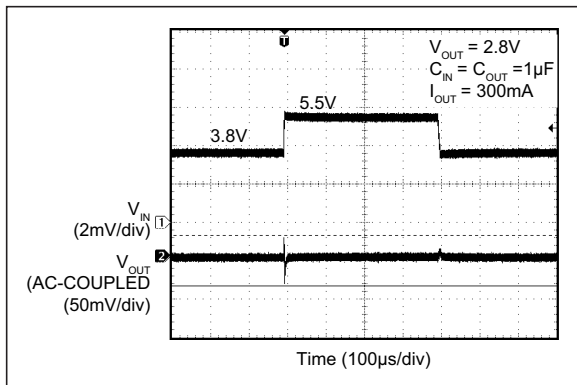
**FIGURE 2-13:** Load Transient.



**FIGURE 2-16:** Auto-Discharge (No Load).



**FIGURE 2-14:** Load Transient.



**FIGURE 2-15:** Line Transient.



## 3.0 PIN DESCRIPTIONS

The descriptions of the pins are listed in [Table 3-1](#).

**TABLE 3-1: PIN FUNCTION TABLE**

4-Lead TDFN Pin Number	SOT23-5 Pin Number	Pin Name	Description
1	5	VOUT	Output Voltage. When disabled the MIC5502 and MIC5504 switches on an internal 25Ω load to discharge the external capacitors.
2	2	GND	Ground.
3	3	EN	Enable Input: Active-High. High = ON; Low = OFF. For MIC5501 and MIC5502 do not leave floating. MIC5503 and MIC5504 have an internal pull-down and this pin may be left floating.
4	1	VIN	Supply Input.
—	4	NC	No Connection. Pin is not internally connected.
EP	—	ePAD	Exposed Heatsink Pad. Connect to GND for best thermal performance.

# MIC5501/2/3/4

## 4.0 APPLICATION INFORMATION

MIC5501/2/3/4 are low-noise 300 mA LDOs. The MIC5502 and MIC5504 include an auto-discharge circuit that is switched on when the regulator is disabled through the enable (EN) pin. The MIC5503 and MIC5504 have an internal pull-down resistor on the EN pin to ensure the output is disabled if the control signal is tri-stated. The MIC5501/2/3/4 regulators are fully protected from damage due to fault conditions, offering linear current limiting and thermal shutdown. The MIC5501/2/3/4 is not suitable for RF transmitter systems.

### 4.1 Input Capacitor

The MIC5501/2/3/4 are high performance, high bandwidth devices. An input capacitor of 1  $\mu\text{F}$  is required from the input to ground to provide stability. Low-ESR ceramic capacitors provide optimal performance at a minimum of space. Additional high frequency capacitors, such as small-valued NPO dielectric-type capacitors, help filter out high frequency noise and are good practice in any RF-based circuit. X5R or X7R dielectrics are recommended for the input capacitor. Y5V dielectrics lose most of their capacitance over temperature and are therefore, not recommended.

### 4.2 Output Capacitor

The MIC5501/2/3/4 require an output capacitor of 1  $\mu\text{F}$  or greater to maintain stability. The design is optimized for use with low-ESR ceramic chip capacitors. High ESR capacitors are not recommended because they may cause high frequency oscillation. The output capacitor can be increased, but performance has been optimized for a 1  $\mu\text{F}$  ceramic output capacitor and does not improve significantly with larger capacitance.

X7R/X5R dielectric-type ceramic capacitors are recommended because of their temperature performance. X7R-type capacitors change capacitance by 15% over their operating temperature range and are the most stable type of ceramic capacitors. Z5U and Y5V dielectric capacitors change value by as much as 50% and 60%, respectively, over their operating temperature ranges. To use a ceramic chip capacitor with Y5V dielectric, the value must be much higher than an X7R ceramic capacitor to ensure the same minimum capacitance over the equivalent operating temperature range.

### 4.3 No-Load Stability

Unlike many other voltage regulators, the MIC5501/2/3/4 remain stable and in regulation with no load. This is especially important in CMOS RAM keep-alive applications.

### 4.4 Enable/Shutdown

The MIC5501/2/3/4 each come with an active-high enable pin that allows the regulator to be disabled. Forcing the EN pin low disables the regulator and sends it into an off mode current state drawing virtually zero current. When disabled, the MIC5502 and MIC5504 switches an internal 25 $\Omega$  load on the regulator output to discharge the external capacitor.

Forcing the EN pin high enables the output voltage. The MIC5501 and MIC5502 enable pin uses CMOS technology and the EN pin cannot be left floating; a floating EN pin may cause an indeterminate state on the output. The MIC5503 and MIC5504 have an internal pull-down resistor on the enable pin to disable the output when the enable pin is floating.

### 4.5 Thermal Considerations

The MIC5501/2/3/4 are designed to provide 300 mA of continuous current in a very small package. Maximum ambient operating temperature can be calculated based on the output current and the voltage drop across the part. For example if the input voltage is 3.6V, the output voltage is 2.8V, and the output current is 300 mA. The actual power dissipation of the regulator circuit can be determined using [Equation 4-1](#):

#### EQUATION 4-1:

$$P_D = (V_{IN} - V_{OUT1}) \times I_{OUT} + V_{IN} \times I_{GND}$$

Because this device is CMOS and the ground current is typically <100  $\mu\text{A}$  over the load range, the power dissipation contributed by the ground current is < 1% and can be ignored for this calculation:

#### EQUATION 4-2:

$$P_D = (3.6V - 2.8V) \times 300mA = 0.240W$$

To determine the maximum ambient operating temperature of the package, use the junction-to-ambient thermal resistance of the device and [Equation 4-3](#):

#### EQUATION 4-3:

$$P_{D(MAX)} = \frac{T_{J(MAX)} - T_A}{\theta_{JA}}$$

Where:

$T_{J(MAX)}$  = 125°C, the max. junction temp. of the die.

$\theta_{JA}$  = Thermal resistance of 250°C/W for the DFN package.

Substituting PD for  $P_{D(MAX)}$  and solving for the ambient operating temperature will give the maximum operating conditions for the regulator circuit. The junction-to-ambient thermal resistance for the minimum footprint is  $250^{\circ}\text{C}/\text{W}$ .

The maximum power dissipation must not be exceeded for proper operation.

For example, when operating the MIC5501-YMT at an input voltage of 3.6V and 300 mA load with a minimum footprint layout, the maximum ambient operating temperature  $T_A$  can be determined as follows:

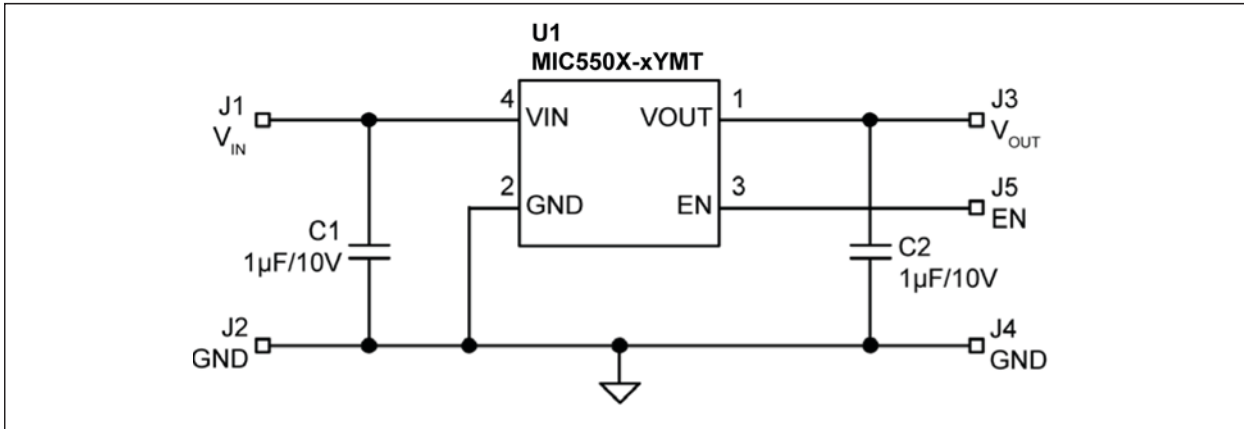
**EQUATION 4-4:**

$$0.240\text{ W} = (125^{\circ}\text{C} - T_A) / 250^{\circ}\text{C}/\text{W}$$
$$T_A = 65^{\circ}\text{C}$$

Therefore, the maximum ambient operating temperature allowed in a  $1\text{ mm} \times 1\text{ mm}$  DFN package is  $65^{\circ}\text{C}$ . For a full discussion of heat sinking and thermal effects on voltage regulators, refer to the “Regulator Thermals” section of Microchip’s [Designing with Low-Dropout Voltage Regulators](#) handbook.

# MIC5501/2/3/4

## 5.0 TYPICAL APPLICATION SCHEMATICS



**FIGURE 5-1:** MIC550x.xYMT Typical Application Schematic.

**TABLE 5-1: BILL OF MATERIALS**

Item	Part Number	Manufacturer	Description	Qty.
C1, C2	GRM155R61A105KE15D	Murata	Capacitor, 1 µF Ceramic, 10V, X5R, Size 0402	2
U1	MIC5501-x.xYMT	Microchip	300 mA Single Output LDO in Small Packages	1
	MIC5501-x.xYMT			
	MIC5501-x.xYMT			
	MIC5501-x.xYMT			

## 6.0 PCB LAYOUT RECOMMENDATIONS

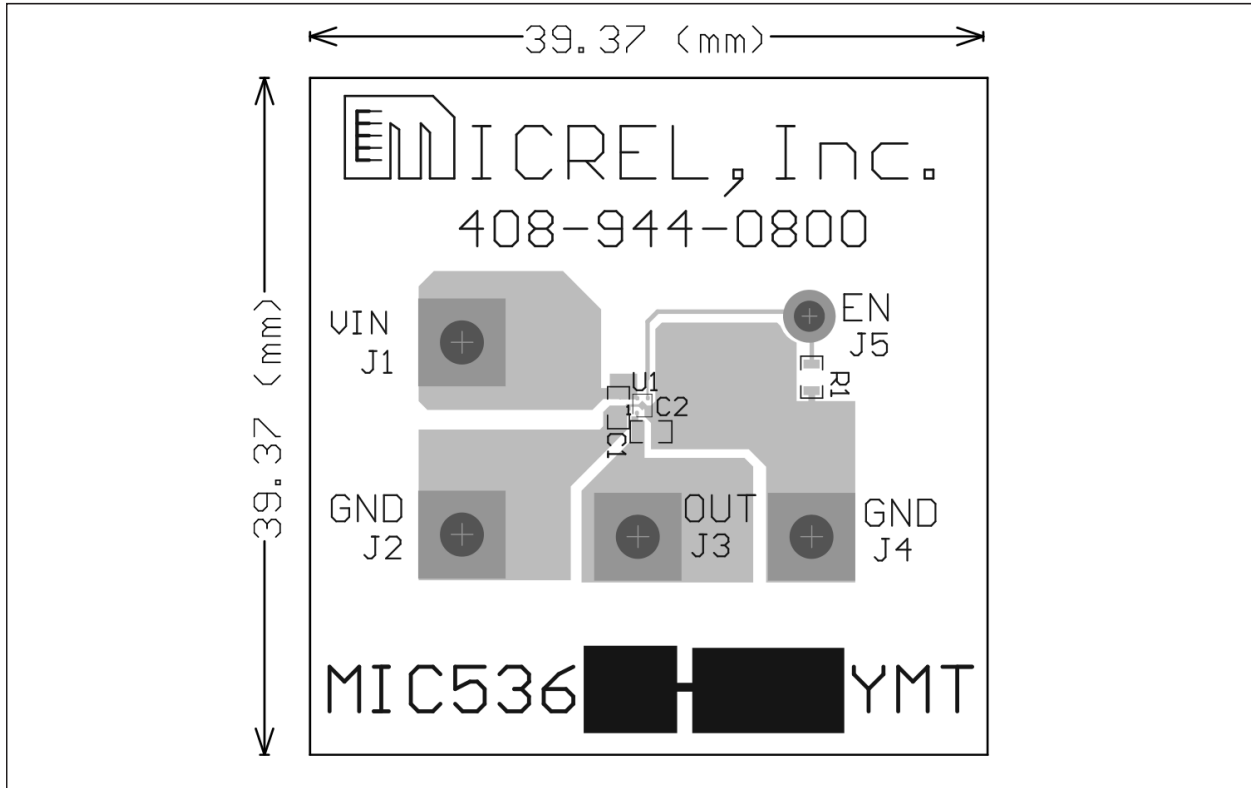


FIGURE 6-1: Top Layer.

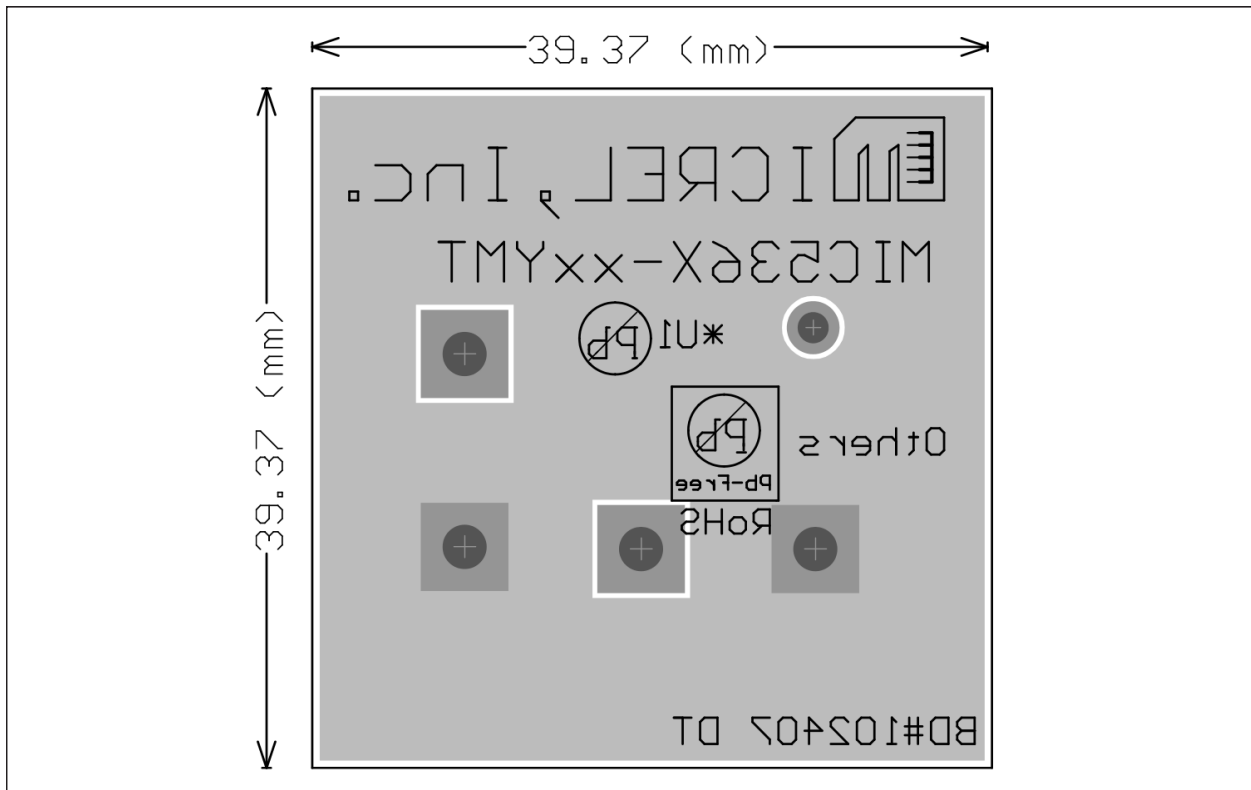


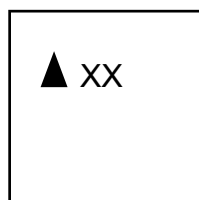
FIGURE 6-2: Bottom Layer.

# MIC5501/2/3/4

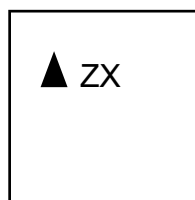
## 7.0 PACKAGING INFORMATION

### 7.1 Package Marking Information

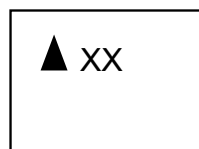
4-Lead TDFN\*



Example



5-Lead SOT23\*



Example

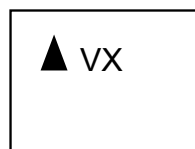


TABLE 7-1: ABBREVIATED TOP MARK

Device	Package	Feature	Output Voltage								
			1.0V	1.2V	1.8V	2.2V	2.5V	2.8V	3.0V	3.1V	3.3V
MIC5501	4L TDFN (MT)	General Purpose	—	—	—	—	—	—	VP	—	—
MIC5501	5L SOT23 (M5)	General Purpose	—	—	—	—	—	—	VX	—	—
MIC5502	4L TDFN (MT)	Auto-Discharge	—	—	XG	—	—	XM	XP	—	—
MIC5502	5L SOT23 (M5)	Auto-Discharge	—	—	—	—	—	—	—	—	—
MIC5503	4L TDFN (MT)	EN Pull-Down	—	XV	YV	—	—	—	—	—	—
MIC5503	5L SOT23 (M5)	EN Pull-Down	—	—	—	—	—	—	—	—	—
MIC5504	4L TDFN (MT)	Auto-Discharge & EN Pull-Down	CX	ZX	GX	UW	UX	MX	PX	TX	SX
MIC5504	5L SOT23 (M5)	Auto-Discharge & EN Pull-Down	—	WX4	WXG	—	WXJ	WXM	WXP	—	WXS

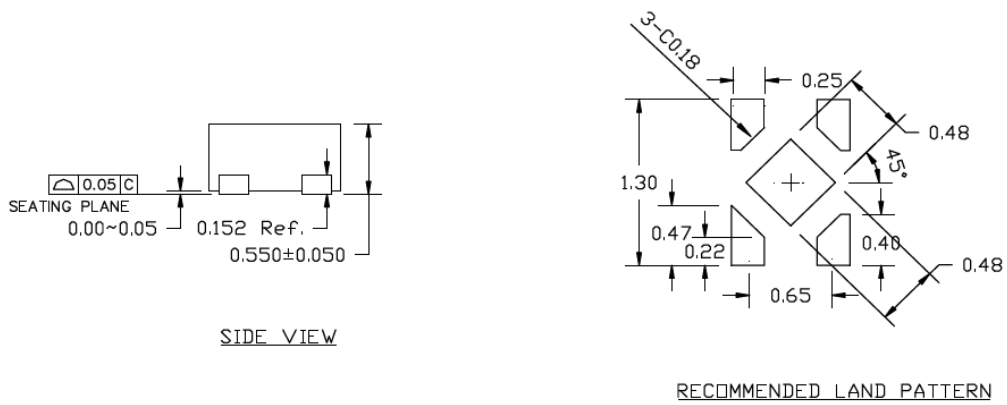
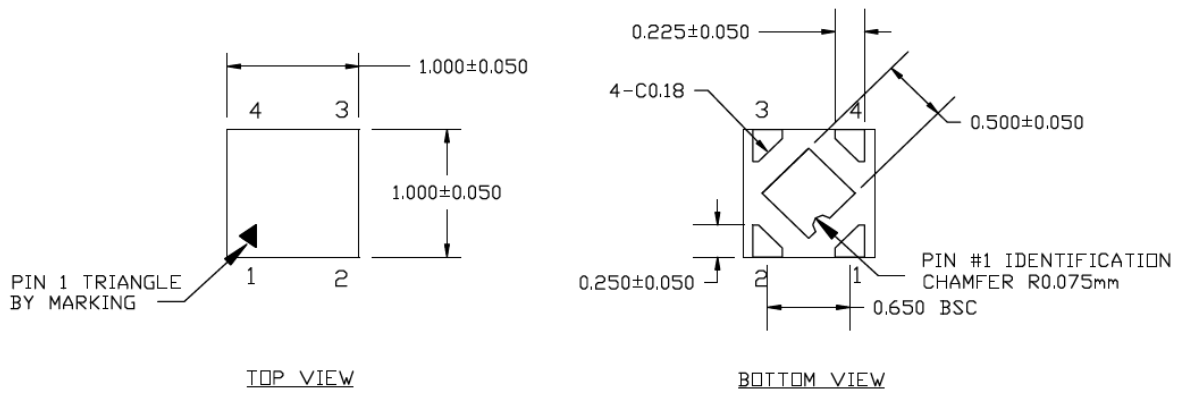
<p><b>Legend:</b> XX...X Product code or customer-specific information          Y Year code (last digit of calendar year)          YY Year code (last 2 digits of calendar year)          WW Week code (week of January 1 is week '01')          NNN Alphanumeric traceability code          (e3) Pb-free JEDEC® designator for Matte Tin (Sn)          * This package is Pb-free. The Pb-free JEDEC designator ((e3)) can be found on the outer packaging for this package.</p> <p>•, ▲, ▼ Pin one index is identified by a dot, delta up, or delta down (triangle mark).</p>	<p><b>Note:</b> In the event the full Microchip part number cannot be marked on one line, it will be carried over to the next line, thus limiting the number of available characters for customer-specific information. Package may or may not include the corporate logo.</p> <p>Underbar (¯) and/or Overbar (˘) symbol may not be to scale.</p>
--	---

## 4-Lead TDFN 1 mm x 1 mm Package Outline and Recommended Land Pattern

**TITLE**

4 LEAD TDFN 1.0x1.0mm PACKAGE OUTLINE & RECOMMENDED LAND PATTERN

DRAWING #	TDFN1010-4LD-PL-2	UNIT	MM
-----------	-------------------	------	----

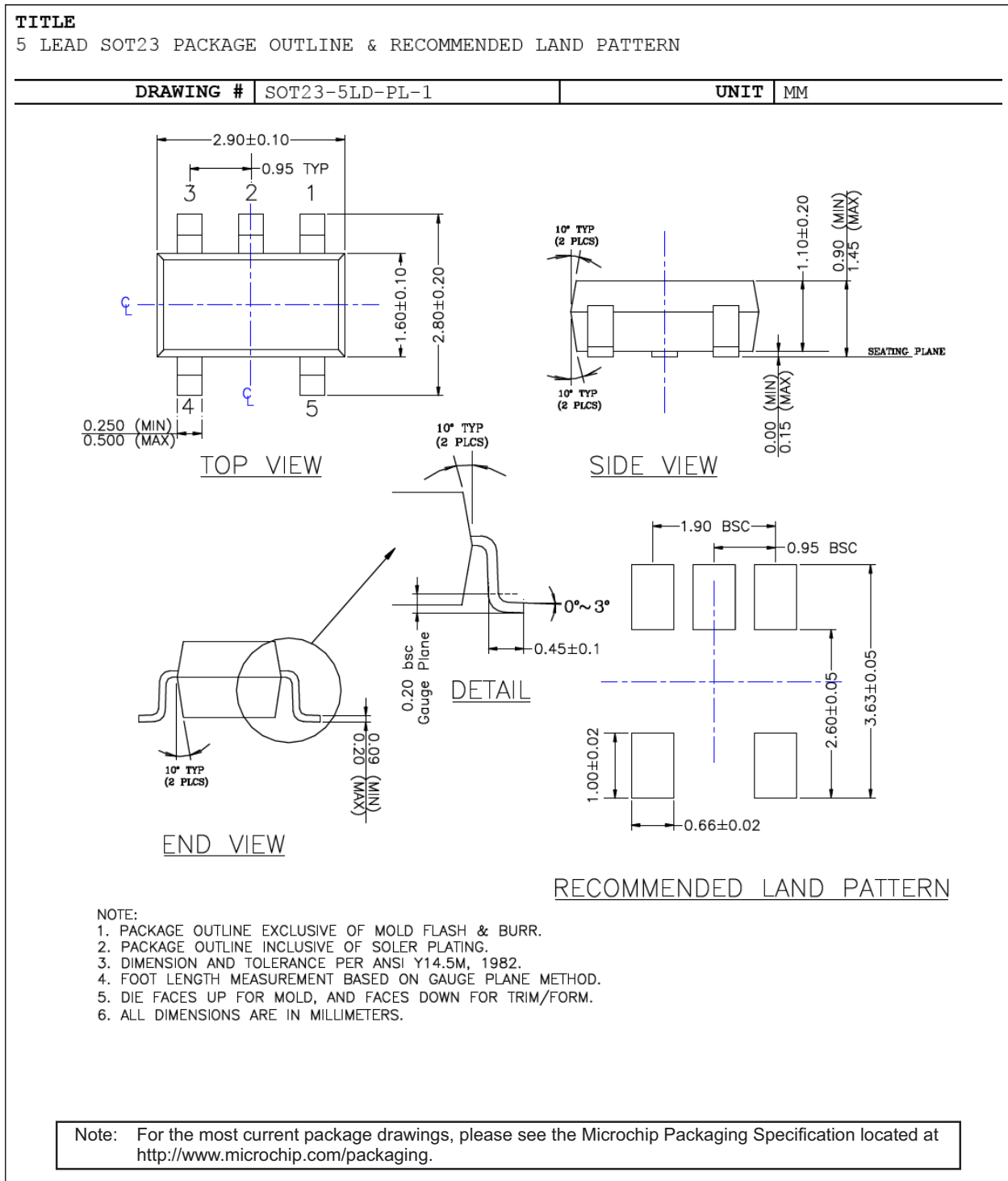


- NOTE:
1. MAX PACKAGE WARPAGE IS 0.05 MM
  2. MAX ALLOWABLE BURR IS 0.076MM IN ALL DIRECTIONS
  3. PIN #1 IS ON TOP WILL BE LASER MARKED
  4. UNSPECIFIED TOLERANCE IS +/- 0.05 MM

Note: For the most current package drawings, please see the Microchip Packaging Specification located at <http://www.microchip.com/packaging>.

# MIC5501/2/3/4

## 5-Lead SOT23 Package Outline and Recommended Land Pattern





## APPENDIX A: REVISION HISTORY

### Revision A (April 2018)

- Converted Micrel document MIC5501/2/3/4 to Microchip data sheet DS20006006B.
- Minor text changes throughout.

### Revision B (October 2019)

- Updated **Section 4.0 “Application Information”** with adding this new sentence - The MIC5501/2/3/4 is not suitable for RF transmitter systems.
- Added on the **Section 5.0 “Typical Application Schematics”** and **Section 6.0 “PCB Layout Recommendations”** due to non availability of Evaluation Board document.

# MIC5501/2/3/4

---

NOTES:

## PRODUCT IDENTIFICATION SYSTEM

To order or obtain information, e.g., on pricing or delivery, contact your local Microchip representative or sales office.

Device	-X.X	X	XX	-XX	Examples:	
Part No.	Output Voltage	Junction Temp. Range	Package	Media Type		
<b>Device:</b>	MIC5501:	Single 300 mA LDO, General Purpose			a) MIC5501-1.8YMT-T5:	MIC5501, 1.8V Fixed Output Voltage, -40°C to +125°C Temperature Range, 4-Lead TDFN, 500/Reel
	MIC5502:	Single 300 mA LDO, Auto-Discharge			b) MIC5501-3.0YMT-TR:	MIC5501, 3.0V Fixed Output Voltage, -40°C to +125°C Temperature Range, 4-Lead TDFN, 5,000/Reel
	MIC5503:	Single 300 mA LDO, Internal EN Pull-Down			c) MIC5501-3.0YM5-TR:	MIC5501, 3.0V Fixed Output Voltage, -40°C to +125°C Temperature Range, 5-Lead SOT23, 3,000/Reel
	MIC5504:	Single 300 mA LDO, Auto-Discharge and Internal EN Pull-Down			d) MIC5502-2.8YMT-TR:	MIC5502, 2.8V Fixed Output Voltage, -40°C to +125°C Temperature Range, 4-Lead TDFN, 5,000/Reel
<b>Output Voltage:</b>	1.0 =	1.0V (MIC5504/MT)			e) MIC5503-1.2YMT-TR:	MIC5503, 1.2V Fixed Output Voltage, -40°C to +125°C Temperature Range, 4-Lead TDFN, 5,000/Reel
	1.2 =	1.2V (MIC5503/4)			f) MIC5504-1.0YMT-T5:	MIC5504, 1.0V Fixed Output Voltage, -40°C to +125°C Temperature Range, 4-Lead TDFN, 500/Reel
	1.8 =	1.8V (MIC5501/2/3/4)			g) MIC5504-2.2YMT-TR:	MIC5504, 2.2V Fixed Output Voltage, -40°C to +125°C Temperature Range, 4-Lead TDFN, 5,000/Reel
	2.2 =	2.2V (MIC5504/MT)			h) MIC5504-3.1YMT-TZ:	MIC5504, 3.1V Fixed Output Voltage, -40°C to +125°C Temperature Range, 4-Lead TDFN, 10,000/Reel
	2.5 =	2.5V (MIC5504)				
	2.8 =	2.8V (MIC5502/4)				
	3.0 =	3.0V (MIC5501/2/4)				
	3.1 =	3.1V (MIC5504/MT)				
	3.3 =	3.3V (MIC5504)				
<b>Junction Temperature Range:</b>	Y =	-40°C to +125°C, RoHS-Compliant				
<b>Package:</b>	MT =	4-Lead 1 mm x 1 mm TDFN				
	M5 =	5-Lead SOT23				
<b>Media Type:</b>	T5 =	500/Reel				
	TR =	3,000/Reel (SOT23)				
	TR =	5,000/Reel (TDFN)				
	TZ =	10,000/Reel (TDFN)				
<b>Note:</b> Other voltage options available. Contact your Microchip sales office.					<b>Note 1:</b> Tape and Reel identifier only appears in the catalog part number description. This identifier is used for ordering purposes and is not printed on the device package. Check with your Microchip Sales Office for package availability with the Tape and Reel option.	

# MIC5501/2/3/4

---

NOTES:

---

---

**Note the following details of the code protection feature on Microchip devices:**

- Microchip products meet the specification contained in their particular Microchip Data Sheet.
- Microchip believes that its family of products is one of the most secure families of its kind on the market today, when used in the intended manner and under normal conditions.
- There are dishonest and possibly illegal methods used to breach the code protection feature. All of these methods, to our knowledge, require using the Microchip products in a manner outside the operating specifications contained in Microchip's Data Sheets. Most likely, the person doing so is engaged in theft of intellectual property.
- Microchip is willing to work with the customer who is concerned about the integrity of their code.
- Neither Microchip nor any other semiconductor manufacturer can guarantee the security of their code. Code protection does not mean that we are guaranteeing the product as “unbreakable.”

Code protection is constantly evolving. We at Microchip are committed to continuously improving the code protection features of our products. Attempts to break Microchip's code protection feature may be a violation of the Digital Millennium Copyright Act. If such acts allow unauthorized access to your software or other copyrighted work, you may have a right to sue for relief under that Act.

---

Information contained in this publication regarding device applications and the like is provided only for your convenience and may be superseded by updates. It is your responsibility to ensure that your application meets with your specifications. MICROCHIP MAKES NO REPRESENTATIONS OR WARRANTIES OF ANY KIND WHETHER EXPRESS OR IMPLIED, WRITTEN OR ORAL, STATUTORY OR OTHERWISE, RELATED TO THE INFORMATION, INCLUDING BUT NOT LIMITED TO ITS CONDITION, QUALITY, PERFORMANCE, MERCHANTABILITY OR FITNESS FOR PURPOSE. Microchip disclaims all liability arising from this information and its use. Use of Microchip devices in life support and/or safety applications is entirely at the buyer's risk, and the buyer agrees to defend, indemnify and hold harmless Microchip from any and all damages, claims, suits, or expenses resulting from such use. No licenses are conveyed, implicitly or otherwise, under any Microchip intellectual property rights unless otherwise stated.

### Trademarks

The Microchip name and logo, the Microchip logo, Adaptec, AnyRate, AVR, AVR logo, AVR Freaks, BesTime, BitCloud, chipKIT, chipKIT logo, CryptoMemory, CryptoRF, dsPIC, FlashFlex, flexPWR, HELDO, IGLOO, JukeBlox, KeeLoq, Klear, LANCheck, LinkMD, maXStylus, maXTouch, MediaLB, megaAVR, Microsemi, Microsemi logo, MOST, MOST logo, MPLAB, OptoLyzer, PackeTime, PIC, picoPower, PICSTART, PIC32 logo, PolarFire, Prochip Designer, QTouch, SAM-BA, SenGenuity, SpyNIC, SST, SST Logo, SuperFlash, Symmetricom, SyncServer, Tachyon, TempTrackr, TimeSource, tinyAVR, UNI/O, Vectron, and XMEGA are registered trademarks of Microchip Technology Incorporated in the U.S.A. and other countries.

APT, ClockWorks, The Embedded Control Solutions Company, EtherSynch, FlashTec, Hyper Speed Control, HyperLight Load, IntelliMOS, Libero, motorBench, mTouch, Powermite 3, Precision Edge, ProASIC, ProASIC Plus, ProASIC Plus logo, Quiet-Wire, SmartFusion, SyncWorld, Temux, TimeCesium, TimeHub, TimePictra, TimeProvider, Vite, WinPath, and ZL are registered trademarks of Microchip Technology Incorporated in the U.S.A.

Adjacent Key Suppression, AKS, Analog-for-the-Digital Age, Any Capacitor, AnyIn, AnyOut, BlueSky, BodyCom, CodeGuard, CryptoAuthentication, CryptoAutomotive, CryptoCompanion, CryptoController, dsPICDEM, dsPICDEM.net, Dynamic Average Matching, DAM, ECAN, EtherGREEN, In-Circuit Serial Programming, ICSP, INICnet, Inter-Chip Connectivity, JitterBlocker, KlearNet, KlearNet logo, memBrain, Mindi, MiWi, MPASM, MPF, MPLAB Certified logo, MPLIB, MPLINK, MultiTRAK, NetDetach, Omniscient Code Generation, PICDEM, PICDEM.net, PICKit, PICtail, PowerSmart, PureSilicon, QMatrix, REAL ICE, Ripple Blocker, SAM-ICE, Serial Quad I/O, SMART-I.S., SQI, SuperSwitcher, SuperSwitcher II, Total Endurance, TSHARC, USBCheck, VariSense, ViewSpan, WiperLock, Wireless DNA, and ZENA are trademarks of Microchip Technology Incorporated in the U.S.A. and other countries.

SQTP is a service mark of Microchip Technology Incorporated in the U.S.A.

The Adaptec logo, Frequency on Demand, Silicon Storage Technology, and Symmcom are registered trademarks of Microchip Technology Inc. in other countries.

GestIC is a registered trademark of Microchip Technology Germany II GmbH & Co. KG, a subsidiary of Microchip Technology Inc., in other countries.

All other trademarks mentioned herein are property of their respective companies.

© 2019, Microchip Technology Incorporated, All Rights Reserved.

ISBN: 978-1-5224-5154-9

For information regarding Microchip's Quality Management Systems, please visit [www.microchip.com/quality](http://www.microchip.com/quality).



# MICROCHIP

## Worldwide Sales and Service

### AMERICAS

**Corporate Office**  
2355 West Chandler Blvd.  
Chandler, AZ 85224-6199  
Tel: 480-792-7200  
Fax: 480-792-7277  
Technical Support:  
<http://www.microchip.com/support>  
Web Address:  
[www.microchip.com](http://www.microchip.com)

#### Atlanta

Duluth, GA  
Tel: 678-957-9614  
Fax: 678-957-1455

#### Austin, TX

Tel: 512-257-3370

#### Boston

Westborough, MA  
Tel: 774-760-0087  
Fax: 774-760-0088

#### Chicago

Itasca, IL  
Tel: 630-285-0071  
Fax: 630-285-0075

#### Dallas

Addison, TX  
Tel: 972-818-7423  
Fax: 972-818-2924

#### Detroit

Novi, MI  
Tel: 248-848-4000

#### Houston, TX

Tel: 281-894-5983

#### Indianapolis

Noblesville, IN  
Tel: 317-773-8323  
Fax: 317-773-5453  
Tel: 317-536-2380

#### Los Angeles

Mission Viejo, CA  
Tel: 949-462-9523  
Fax: 949-462-9608  
Tel: 951-273-7800

#### Raleigh, NC

Tel: 919-844-7510

#### New York, NY

Tel: 631-435-6000

#### San Jose, CA

Tel: 408-735-9110  
Tel: 408-436-4270

#### Canada - Toronto

Tel: 905-695-1980  
Fax: 905-695-2078

### ASIA/PACIFIC

**Australia - Sydney**  
Tel: 61-2-9868-6733

**China - Beijing**  
Tel: 86-10-8569-7000

**China - Chengdu**  
Tel: 86-28-8665-5511

**China - Chongqing**  
Tel: 86-23-8980-9588

**China - Dongguan**  
Tel: 86-769-8702-9880

**China - Guangzhou**  
Tel: 86-20-8755-8029

**China - Hangzhou**  
Tel: 86-571-8792-8115

**China - Hong Kong SAR**  
Tel: 852-2943-5100

**China - Nanjing**  
Tel: 86-25-8473-2460

**China - Qingdao**  
Tel: 86-532-8502-7355

**China - Shanghai**  
Tel: 86-21-3326-8000

**China - Shenyang**  
Tel: 86-24-2334-2829

**China - Shenzhen**  
Tel: 86-755-8864-2200

**China - Suzhou**  
Tel: 86-186-6233-1526

**China - Wuhan**  
Tel: 86-27-5980-5300

**China - Xian**  
Tel: 86-29-8833-7252

**China - Xiamen**  
Tel: 86-592-2388138

**China - Zhuhai**  
Tel: 86-756-3210040

### ASIA/PACIFIC

**India - Bangalore**  
Tel: 91-80-3090-4444

**India - New Delhi**  
Tel: 91-11-4160-8631

**India - Pune**  
Tel: 91-20-4121-0141

**Japan - Osaka**  
Tel: 81-6-6152-7160

**Japan - Tokyo**  
Tel: 81-3-6880-3770

**Korea - Daegu**  
Tel: 82-53-744-4301

**Korea - Seoul**  
Tel: 82-2-554-7200

**Malaysia - Kuala Lumpur**  
Tel: 60-3-7651-7906

**Malaysia - Penang**  
Tel: 60-4-227-8870

**Philippines - Manila**  
Tel: 63-2-634-9065

**Singapore**  
Tel: 65-6334-8870

**Taiwan - Hsin Chu**  
Tel: 886-3-577-8366

**Taiwan - Kaohsiung**  
Tel: 886-7-213-7830

**Taiwan - Taipei**  
Tel: 886-2-2508-8600

**Thailand - Bangkok**  
Tel: 66-2-694-1351

**Vietnam - Ho Chi Minh**  
Tel: 84-28-5448-2100

### EUROPE

**Austria - Wels**  
Tel: 43-7242-2244-39  
Fax: 43-7242-2244-393

**Denmark - Copenhagen**  
Tel: 45-4450-2828  
Fax: 45-4485-2829

**Finland - Espoo**  
Tel: 358-9-4520-820

**France - Paris**  
Tel: 33-1-69-53-63-20  
Fax: 33-1-69-30-90-79

**Germany - Garching**  
Tel: 49-8931-9700

**Germany - Haan**  
Tel: 49-2129-3766400

**Germany - Heilbronn**  
Tel: 49-7131-72400

**Germany - Karlsruhe**  
Tel: 49-721-625370

**Germany - Munich**  
Tel: 49-89-627-144-0  
Fax: 49-89-627-144-44

**Germany - Rosenheim**  
Tel: 49-8031-354-560

**Israel - Ra'anana**  
Tel: 972-9-744-7705

**Italy - Milan**  
Tel: 39-0331-742611  
Fax: 39-0331-466781

**Italy - Padova**  
Tel: 39-049-7625286

**Netherlands - Drunen**  
Tel: 31-416-690399  
Fax: 31-416-690340

**Norway - Trondheim**  
Tel: 47-7288-4388

**Poland - Warsaw**  
Tel: 48-22-3325737

**Romania - Bucharest**  
Tel: 40-21-407-87-50

**Spain - Madrid**  
Tel: 34-91-708-08-90  
Fax: 34-91-708-08-91

**Sweden - Gothenberg**  
Tel: 46-31-704-60-40

**Sweden - Stockholm**  
Tel: 46-8-5090-4654

**UK - Wokingham**  
Tel: 44-118-921-5800  
Fax: 44-118-921-5820