

## UCC2720x, 120-V Boot, 3-A Peak, High Frequency, High-Side and Low-Side Driver

### 1 Features

- Drives Two N-Channel MOSFETs in High-Side and Low-Side Configuration
- Negative Voltage Handling on HS (–5 V)
- Maximum Boot Voltage of 120 V
- Maximum VDD Voltage of 20 V
- On-Chip 0.65-V VF, 0.6-Ω RD Bootstrap Diode
- Greater than 1 MHz of Operation
- 20-ns Propagation Delay Times
- 3-A Sink and 3-A Source Output Currents
- 8-ns Rise and 7-ns Fall Time With 1000-pF Load
- 1-ns Delay Matching
- Undervoltage Lockout for High-Side and Low-Side Driver
- Specified from –40°C to 140°C

### 2 Applications

- Power Supplies for Telecom, Datacom, and Merchant Markets
- Half-Bridge Applications and Full-Bridge Converters
- Isolated Bus Architecture
- Two-Switch Forward Converters
- Active-Clamp Forward Converters
- High-Voltage Synchronous-Buck Converters
- Class-D Audio Amplifiers

### 3 Description

The UCC2720x family of high-frequency N-channel MOSFET drivers include a 120-V bootstrap diode and high-side and low-side drivers with independent inputs for maximum control flexibility. This allows for N-channel MOSFET control in half-bridge, full-bridge, two-switch forward, and active clamp forward converters. The low-side and the high-side gate drivers are independently controlled and matched to 1 ns between the turnon and turnoff of each other.

An on-chip bootstrap diode eliminates the external discrete diodes. Undervoltage lockout is provided for both the high-side and the low-side drivers forcing the outputs low if the drive voltage is below the specified threshold.

Two versions of the UCC27200 are offered. The UCC27200 has high noise immune CMOS input thresholds while the UCC27201 has TTL compatible thresholds.

#### Device Information<sup>(1)</sup>

PART NUMBER	PACKAGE	BODY SIZE (NOM)
UCC2720x	SOIC (8)	3.91 mm × 4.90 mm
	SO PowerPAD™ (8)	3.90 mm × 4.89 mm
	VSON (8)	4.00 mm × 4.00 mm

(1) For all available packages, see the orderable addendum at the end of the data sheet.

#### Simplified Application Diagram

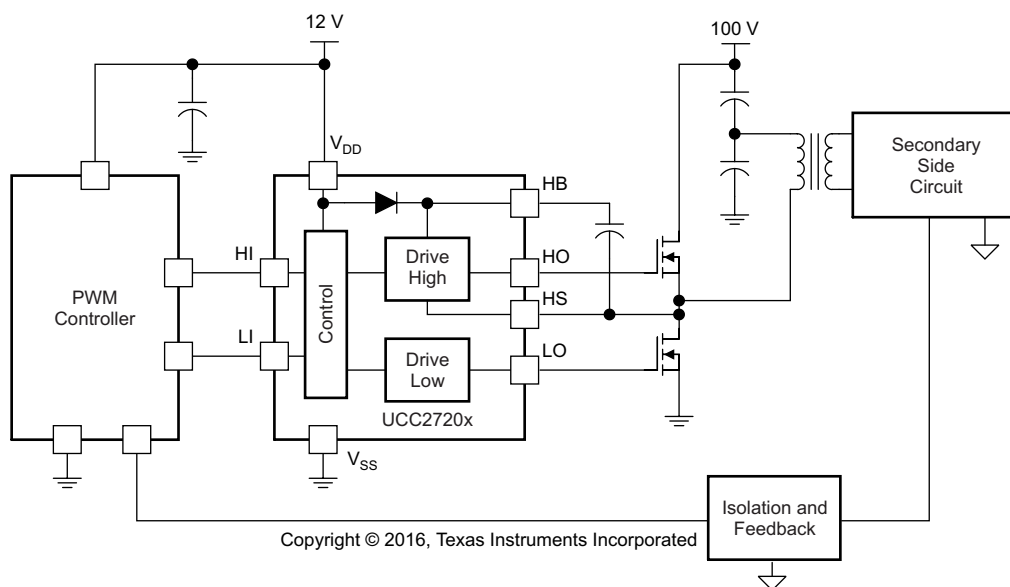

## Table of Contents

<b>1 Features</b> .....	<b>1</b>	7.4 Device Functional Modes.....	<b>13</b>
<b>2 Applications</b> .....	<b>1</b>	<b>8 Application and Implementation</b> .....	<b>14</b>
<b>3 Description</b> .....	<b>1</b>	8.1 Application Information.....	<b>14</b>
<b>4 Revision History</b> .....	<b>2</b>	8.2 Typical Application .....	<b>15</b>
<b>5 Pin Configuration and Functions</b> .....	<b>3</b>	<b>9 Power Supply Recommendations</b> .....	<b>20</b>
<b>6 Specifications</b> .....	<b>4</b>	<b>10 Layout</b> .....	<b>21</b>
6.1 Absolute Maximum Ratings .....	<b>4</b>	10.1 Layout Guidelines .....	<b>21</b>
6.2 ESD Ratings.....	<b>4</b>	10.2 Layout Example .....	<b>21</b>
6.3 Recommended Operating Conditions.....	<b>4</b>	<b>11 Device and Documentation Support</b> .....	<b>22</b>
6.4 Thermal Information .....	<b>5</b>	11.1 Documentation Support .....	<b>22</b>
6.5 Electrical Characteristics.....	<b>5</b>	11.2 Related Links .....	<b>22</b>
6.6 Typical Characteristics .....	<b>8</b>	11.3 Community Resources.....	<b>22</b>
<b>7 Detailed Description</b> .....	<b>12</b>	11.4 Trademarks .....	<b>22</b>
7.1 Overview .....	<b>12</b>	11.5 Electrostatic Discharge Caution.....	<b>22</b>
7.2 Functional Block Diagram .....	<b>12</b>	11.6 Glossary .....	<b>22</b>
7.3 Feature Description.....	<b>12</b>	<b>12 Mechanical, Packaging, and Orderable Information</b> .....	<b>22</b>

## 4 Revision History

NOTE: Page numbers for previous revisions may differ from page numbers in the current version.

### Changes from Revision B (November 2008) to Revision C

Page

<ul style="list-style-type: none"> <li>Added <i>Device Information</i> table, <i>Revision History</i> section, <i>Pin Configuration and Functions</i> section, <i>Specifications</i> section, <i>Detailed Description</i> section, <i>Application and Implementation</i> section, <i>Power Supply Recommendations</i> section, <i>Layout</i> section, <i>Device and Documentation Support</i> section, and <i>Mechanical, Packaging, and Orderable Information</i> section .....</li> </ul>	<b>1</b>
---	----------

## 5 Pin Configuration and Functions

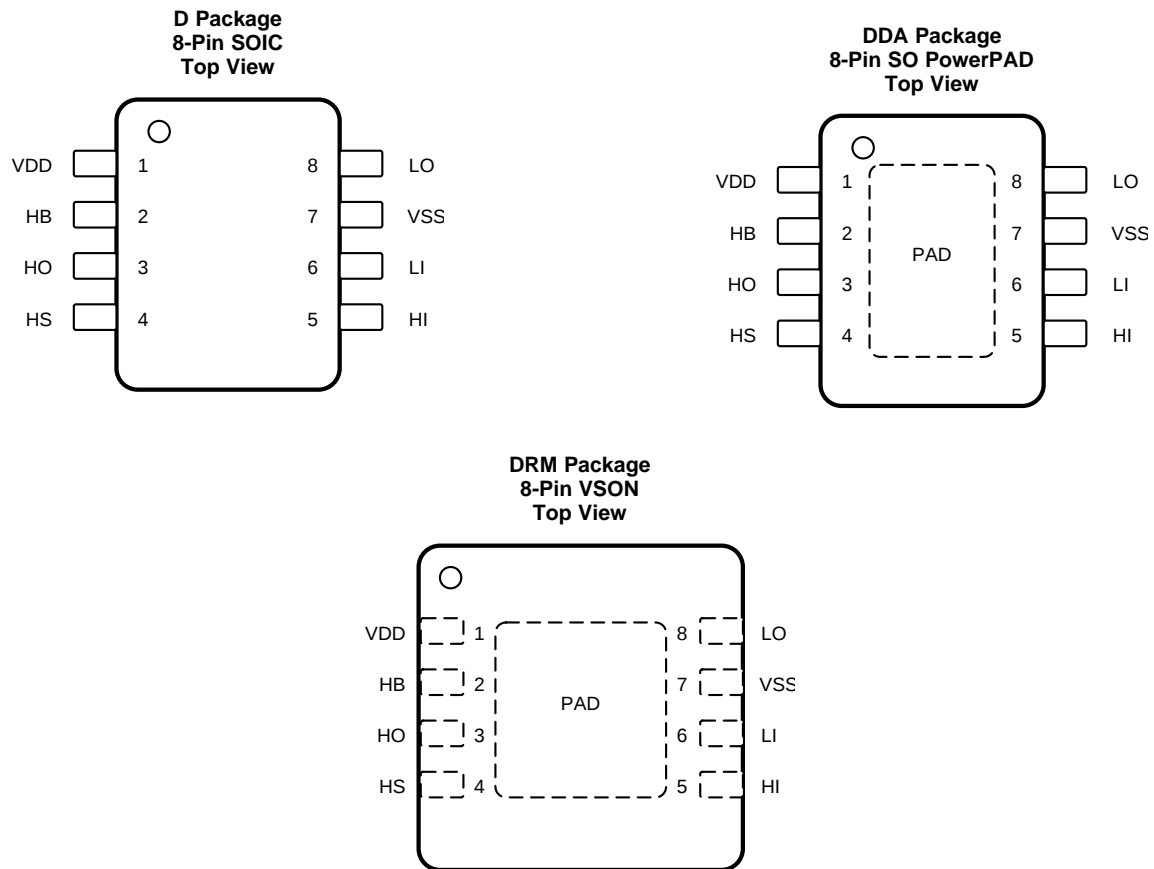

### Pin Functions

PIN		I/O	DESCRIPTION
NAME	NO.		
HB	2	I	High-side bootstrap supply. The bootstrap diode is on-chip but the external bootstrap capacitor is required. Connect positive side of the bootstrap capacitor to this pin. Typical range of HB bypass capacitor is 0.022 $\mu$ F to 0.1 $\mu$ F, the value is dependant on the gate charge of the high-side MOSFET however.
HI	5	I	High-side input.
HO	3	O	High-side output. Connect to the gate of the high-side power MOSFET.
HS	4	I	High-side source connection. Connect to source of high-side power MOSFET. Connect negative side of bootstrap capacitor to this pin.
LI	6	I	Low-side input.
LO	8	O	Low-side output. Connect to the gate of the low-side power MOSFET.
VDD	1	I	Positive supply to the lower gate driver. Decouple this pin to VSS (GND). Typical decoupling capacitor range is 0.22 $\mu$ F to 1 $\mu$ F.
VSS	7	O	Negative supply terminal for the device which is generally grounded.
PowerPAD	PAD	—	Used on the DDA and DRM packages only. Electrically referenced to VSS (GND) <sup>(1)</sup> . Connect to a large thermal mass trace or GND plane to dramatically improve thermal performance.

(1) VSS pin and the exposed thermal die pad are internally connected.

## 6 Specifications

### 6.1 Absolute Maximum Ratings

over operating free-air temperature, unless noted, all voltages are with respect to  $V_{SS}$ .<sup>(1)</sup>

		MIN	MAX	UNIT
Supply voltage, $V_{DD}$ <sup>(2)</sup>		-0.3	20	V
Input voltages on LI and HI, $V_{LI}$ , $V_{HI}$		-0.3	20	V
Output voltage on LO, $V_{LO}$	DC	-0.3	$V_{DD} + 0.3$	V
	Repetitive pulse < 100 ns <sup>(3)</sup>	-2	$V_{DD} + 0.3$	
Output voltage on HO, $V_{HO}$	DC	$V_{HS} - 0.3$	$V_{HB} + 0.3$	V
	Repetitive pulse < 100 ns <sup>(3)</sup>	$V_{HS} - 2$	$V_{HB} + 0.3$	
Voltage on HS, $V_{HS}$	DC	-1	120	V
	Repetitive pulse < 100 ns <sup>(3)</sup>	-5	120	
Voltage on HB, $V_{HB}$		-0.3	120	V
Voltage on HB-HS		-0.3	20	V
Power dissipation at $T_A = 25^\circ\text{C}$	(D package) <sup>(4)</sup>		1.3	W
	(DDA package) <sup>(4)</sup>		2.7	
	(DRM package) <sup>(4)</sup>		3.3	
Lead temperature (soldering, 10 s)			300	°C
Operating virtual junction temperature, $T_J$		-40	150	°C
Storage temperature, $T_{stg}$		-65	150	°C

- (1) Stresses beyond those listed under *Absolute Maximum Ratings* may cause permanent damage to the device. These are stress ratings only, which do not imply functional operation of the device at these or any other conditions beyond those indicated under *Recommended Operating Conditions*. Exposure to absolute-maximum-rated conditions for extended periods may affect device reliability.
- (2) All voltages are with respect to  $V_{SS}$ . Currents are positive into, negative out of the specified terminal.
- (3) Values are verified by characterization and are not production tested.
- (4) This data was taken using the JEDEC proposed high-K test PCB. See *Thermal Information* for details.

### 6.2 ESD Ratings

		VALUE	UNIT
$V_{(ESD)}$ Electrostatic discharge	Human-body model (HBM), per ANSI/ESDA/JEDEC JS-001 <sup>(1)</sup>	±2000	V
	Charged-device model (CDM), per JEDEC specification JESD22-C101 <sup>(2)</sup>	±1000	

- (1) JEDEC document JEP155 states that 500-V HBM allows safe manufacturing with a standard ESD control process.
- (2) JEDEC document JEP157 states that 250-V CDM allows safe manufacturing with a standard ESD control process.

### 6.3 Recommended Operating Conditions

over operating free-air temperature range (unless otherwise noted)

		MIN	NOM	MAX	UNIT
$V_{DD}$	Supply voltage	8	12	17	V
$V_{HS}$	Voltage on HS			105	V
			repetitive pulse < 100 ns	110	
$V_{HB}$	Voltage on HB	$V_{HS} + 8$		115	V
	Voltage slew rate on HS			50	V/ns
$T_J$	Operating junction temperature	-40		140	°C

## 6.4 Thermal Information

 $P_{DISS} = (150 - T_A) / \theta_{JA}$ , unless otherwise noted.

THERMAL METRIC <sup>(1)</sup>		UCC27200, UCC27201			UNIT
		D (SOIC)	DDA (HSOP)	DRM (VSON)	
		8 PINS	8 PINS	8 PINS	
R <sub>θJA</sub>	Junction-to-ambient thermal resistance	106.5	40.5	36.2	°C/W
R <sub>θJC(top)</sub>	Junction-to-case (top) thermal resistance	52.9	49	41.6	°C/W
R <sub>θJB</sub>	Junction-to-board thermal resistance	46.6	10.2	13.2	°C/W
ψ <sub>JT</sub>	Junction-to-top characterization parameter	9.6	3.1	0.6	°C/W
ψ <sub>JB</sub>	Junction-to-board characterization parameter	46.1	9.7	13.4	°C/W
R <sub>θJC(bot)</sub>	Junction-to-case (bottom) thermal resistance	—	1.5	3.1	°C/W

(1) For more information about traditional and new thermal metrics, see the *Semiconductor and IC Package Thermal Metrics* application report, [SPRA953](#).

## 6.5 Electrical Characteristics

over operating free-air temperature range, V<sub>DD</sub> = V<sub>HB</sub> = 12 V, V<sub>HS</sub> = V<sub>SS</sub> = 0 V, No load on LO or HO, T<sub>A</sub> = T<sub>J</sub> = –40°C to 140°C, (unless otherwise noted)

PARAMETER		TEST CONDITIONS	MIN	TYP	MAX	UNIT
<b>SUPPLY CURRENTS</b>						
I <sub>DD</sub>	VDD quiescent current	V <sub>LI</sub> = V <sub>HI</sub> = 0		0.4	0.8	mA
I <sub>DDO</sub>	VDD operating current	f = 500 kHz, C <sub>LOAD</sub> = 0	UCC27200	2.5	4	
			UCC27201	3.8	5.5	
I <sub>HB</sub>	Boot voltage quiescent current	V <sub>LI</sub> = V <sub>HI</sub> = 0 V		0.4	0.8	
I <sub>HBO</sub>	Boot voltage operating current	f = 500 kHz, C <sub>LOAD</sub> = 0		2.5	4	
I <sub>HBS</sub>	HB to V <sub>SS</sub> quiescent current	V <sub>HS</sub> = V <sub>HB</sub> = 110 V		0.0005	1	
I <sub>HBSO</sub>	HB to V <sub>SS</sub> operating current	f = 500 kHz, C <sub>LOAD</sub> = 0		0.1		mA
<b>INPUT</b>						
V <sub>HIT</sub>	Input rising threshold	UCC27200		5.8	8	V
V <sub>LIT</sub>	Input falling threshold		3	5.4		
V <sub>IHYS</sub>	Input voltage hysteresis		0.4			
V <sub>HIT</sub>	Input voltage threshold	UCC27201		1.7	2.5	
V <sub>LIT</sub>	Input voltage threshold		0.8	1.6		
V <sub>IHYS</sub>	Input voltage Hysteresis		100		mV	
R <sub>IN</sub>	Input pulldown resistance		100	200	350	kΩ
<b>UNDERVOLTAGE PROTECTION (UVLO)</b>						
	VDD rising threshold		6.2	7.1	7.8	V
	VDD threshold hysteresis			0.5		
	VHB rising threshold		5.8	6.7	7.2	
	VHB threshold hysteresis			0.4		

**Electrical Characteristics (continued)**

over operating free-air temperature range,  $V_{DD} = V_{HB} = 12\text{ V}$ ,  $V_{HS} = V_{SS} = 0\text{ V}$ , No load on LO or HO,  $T_A = T_J = -40^\circ\text{C}$  to  $140^\circ\text{C}$ , (unless otherwise noted)

PARAMETER		TEST CONDITIONS		MIN	TYP	MAX	UNIT
<b>BOOTSTRAP DIODE</b>							
$V_F$	Low-current forward voltage	$I_{VDD-HB} = 100\ \mu\text{A}$			0.65	0.85	V
$V_{FI}$	High-current forward voltage	$I_{VDD-HB} = 100\ \text{mA}$			0.85	1.1	
$R_D$	Dynamic resistance, $\Delta V_F / \Delta I$	$I_{VDD-HB} = 100\ \text{mA}$ and $80\ \text{mA}$			0.6	1	$\Omega$
<b>LO GATE DRIVER</b>							
$V_{LOL}$	Low-level output voltage	$I_{LO} = 100\ \text{mA}$			0.18	0.4	V
$V_{LOH}$	High-level output voltage	$I_{LO} = -100\ \text{mA}$ , $V_{LOH} = V_{DD} - V_{LO}$	$T_J = -40$ to $125^\circ\text{C}$		0.25	0.4	
	Peak pullup current	$V_{LO} = 0\ \text{V}$			3		A
	Peak pulldown current	$V_{LO} = 12\ \text{V}$			3		
<b>HO GATE DRIVER</b>							
$V_{HOL}$	Low-level output voltage	$I_{HO} = 100\ \text{mA}$			0.18	0.4	V
$V_{HOH}$	High-level output voltage	$I_{HO} = -100\ \text{mA}$ , $V_{HOH} = V_{HB} - V_{HO}$	$T_J = -40$ to $125^\circ\text{C}$		0.25	0.4	
	Peak pullup current	$V_{HO} = 0\ \text{V}$			3		A
	Peak pulldown current	$V_{HO} = 12\ \text{V}$			3		
<b>PROPAGATION DELAYS</b>							
$T_{DLFF}$	$V_{LI}$ falling to $V_{LO}$ falling	$C_{LOAD} = 0$	$T_J = -40$ to $125^\circ\text{C}$		20	45	ns
			$T_J = -40$ to $140^\circ\text{C}$		20	50	
$T_{DHFF}$	$V_{HI}$ falling to $V_{HO}$ falling	$C_{LOAD} = 0$	$T_J = -40$ to $125^\circ\text{C}$		20	45	
			$T_J = -40$ to $140^\circ\text{C}$		20	50	
$T_{DLRR}$	$V_{LI}$ rising to $V_{LO}$ rising	$C_{LOAD} = 0$	$T_J = -40$ to $125^\circ\text{C}$		20	45	
			$T_J = -40$ to $140^\circ\text{C}$		20	50	
$T_{DHRR}$	$V_{HI}$ rising to $V_{HO}$ rising	$C_{LOAD} = 0$	$T_J = -40$ to $125^\circ\text{C}$		20	45	
			$T_J = -40$ to $140^\circ\text{C}$		20	50	
<b>DELAY MATCHING</b>							
$T_{MON}$	LI ON, HI OFF				1	7	ns
$T_{MOFF}$	LI OFF, HI ON				1	7	
<b>OUTPUT RISE AND FALL TIME</b>							
$t_R$	LO, HO	$C_{LOAD} = 1000\ \text{pF}$			8		ns
$t_F$	LO, HO	$C_{LOAD} = 1000\ \text{pF}$			7		
$t_R$	LO, HO (3 V to 9 V)	$C_{LOAD} = 0.1\ \mu\text{F}$			0.35	0.6	us
$t_F$	LO, HO (3 V to 9 V)	$C_{LOAD} = 0.1\ \mu\text{F}$			0.3	0.6	
<b>MISCELLANEOUS</b>							
	Minimum input pulse width that changes the output					50	ns
	Bootstrap diode turn-off time	$I_F = 20\ \text{mA}$ , $I_{REV} = 0.5\ \text{A}^{(1)(2)}$			20		

(1) Typical values for  $T_A = 25^\circ\text{C}$

(2)  $I_F$ : Forward current applied to bootstrap diode,  $I_{REV}$ : Reverse current applied to bootstrap diode.

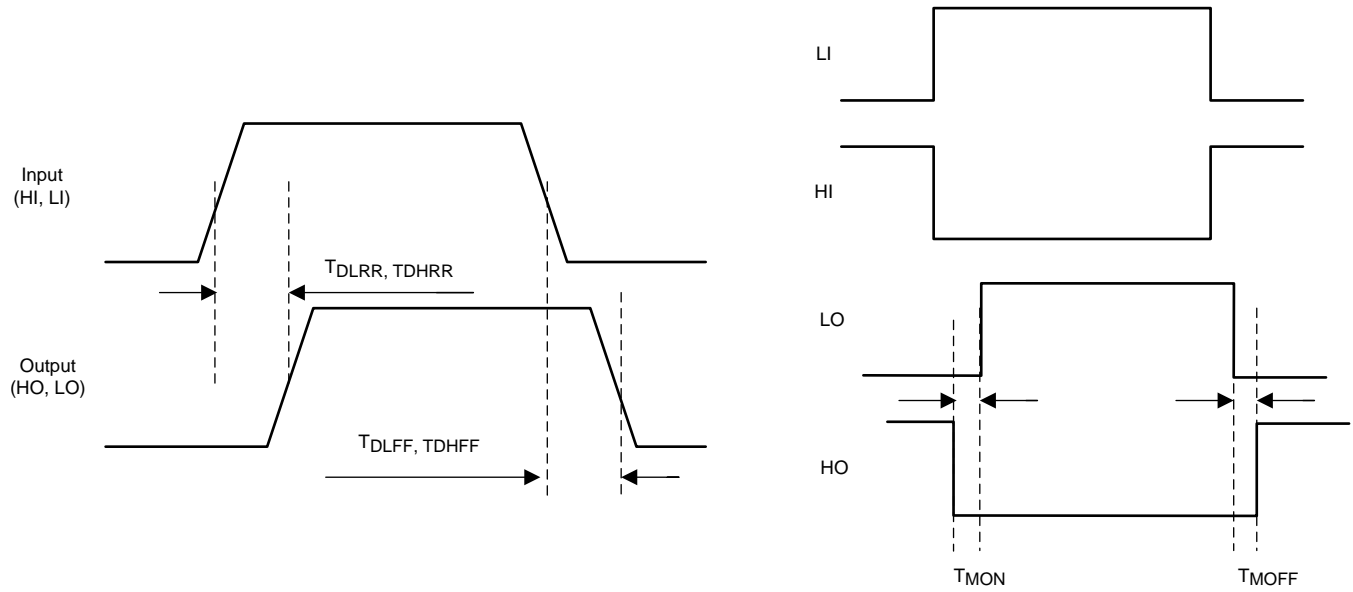

Figure 1. Timing Diagrams

## 6.6 Typical Characteristics

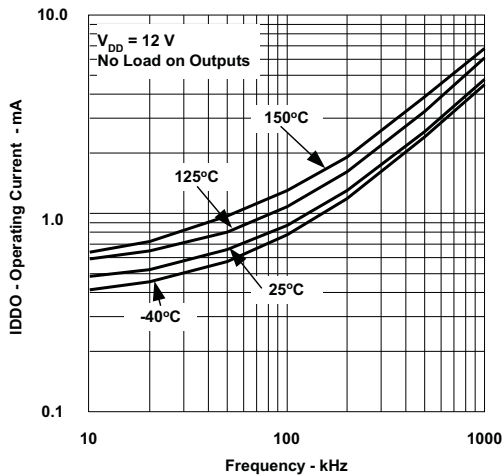

Figure 2. UCC27200 IDD Operating Current vs Frequency

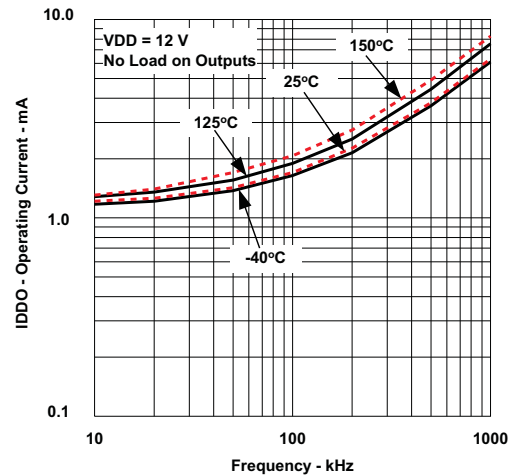

Figure 3. UCC27201 IDD Operating Current vs Frequency

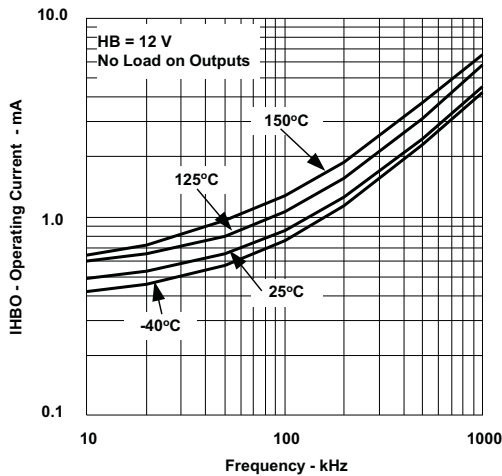

Figure 4. Boot Voltage Operating Current vs Frequency

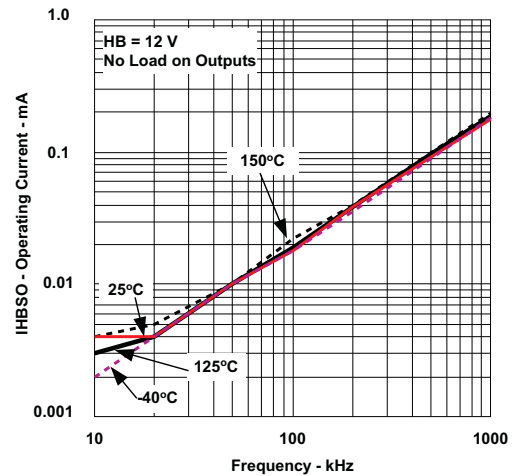

Figure 5. HB to VSS Operating Current vs Frequency

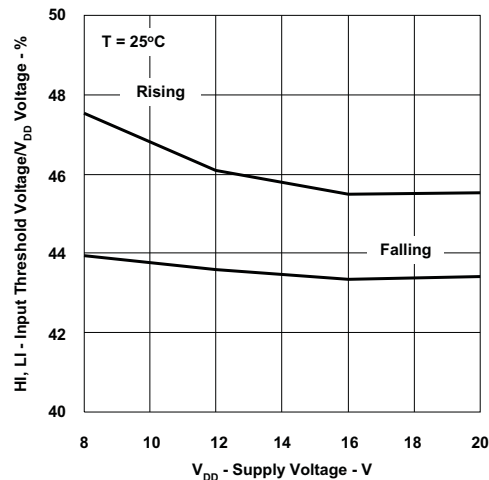

Figure 6. UCC27200 Input Threshold vs Supply Voltage

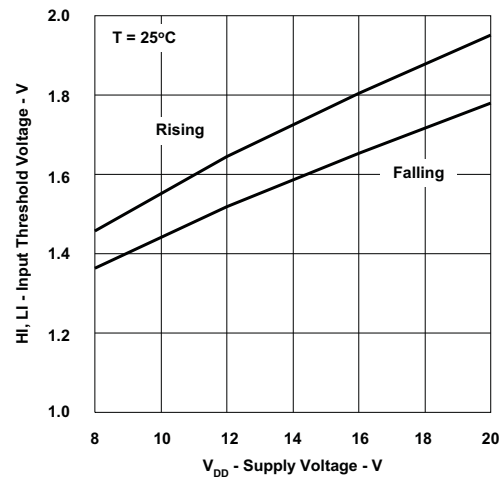
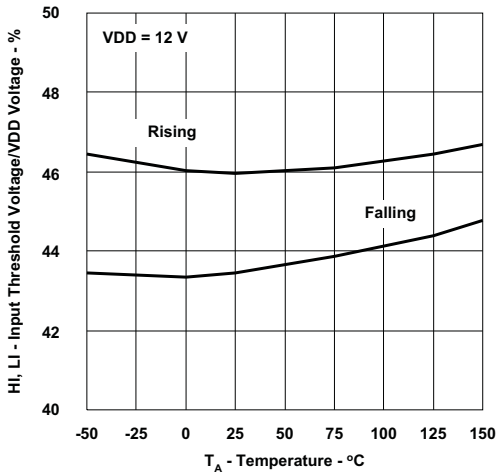

Figure 7. UCC27201 Input Threshold vs Supply Voltage



**Typical Characteristics (continued)**



**Figure 8. UCC27200 Input Threshold vs Temperature**

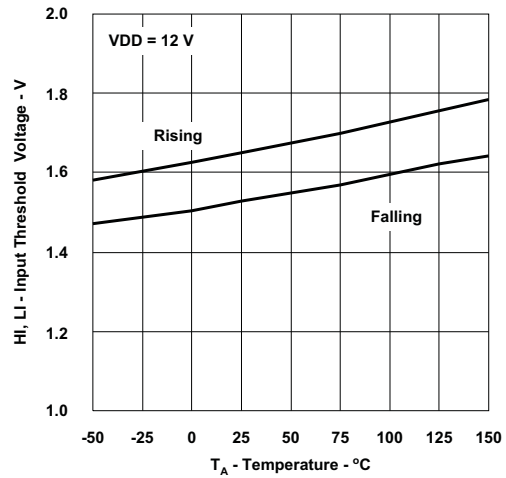

**Figure 9. UCC27201 Input Threshold vs Temperature**

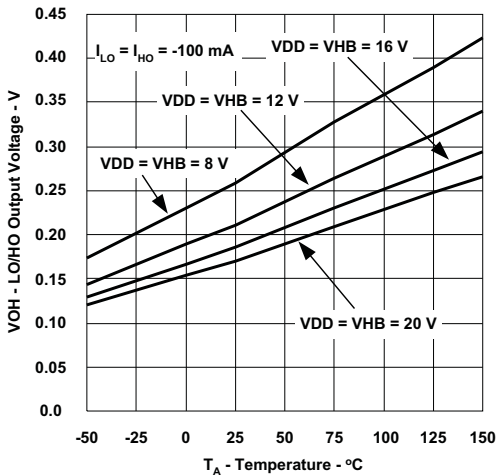

**Figure 10. LO and HO High-Level Output Voltage vs Temperature**

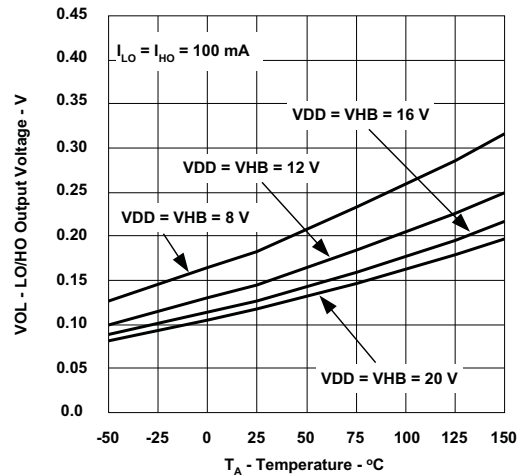

**Figure 11. LO and HO Low-Level Output Voltage vs Temperature**

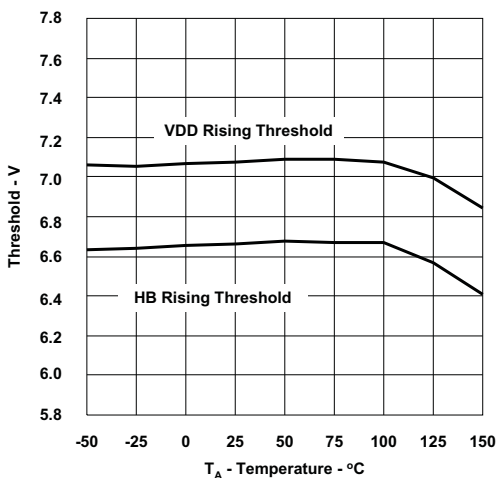

**Figure 12. Undervoltage Lockout Threshold vs Temperature**

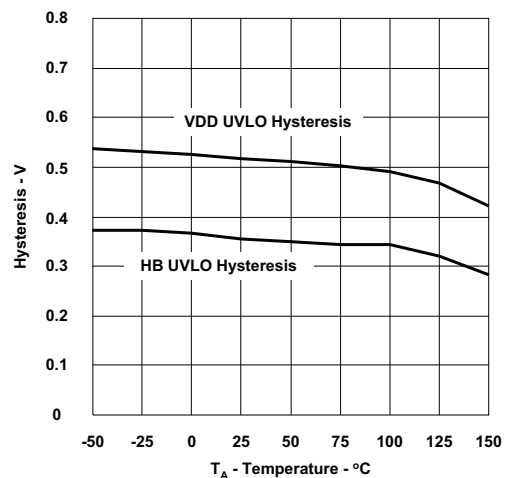

**Figure 13. Undervoltage Lockout Threshold Hysteresis vs Temperature**

Typical Characteristics (continued)

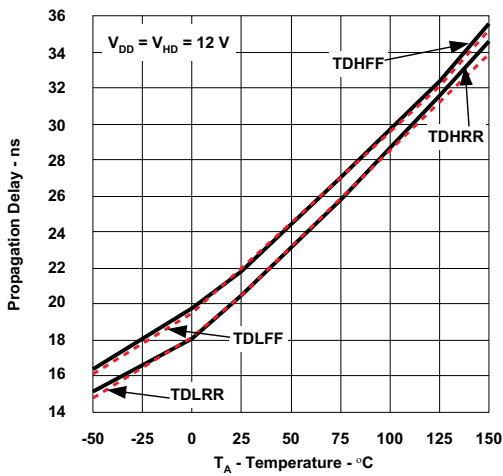

Figure 14. UCC27200 Propagation Delays vs Temperature

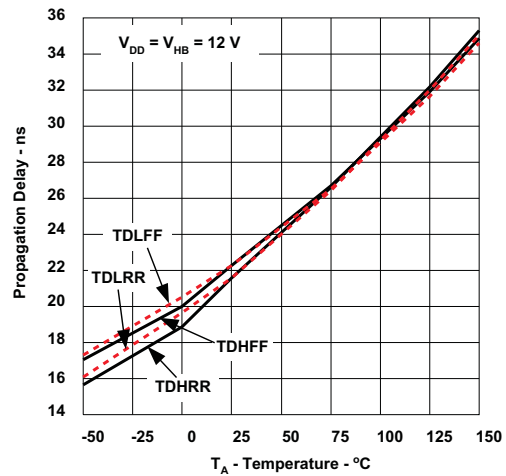

Figure 15. UCC27201 Propagation Delays vs Temperature

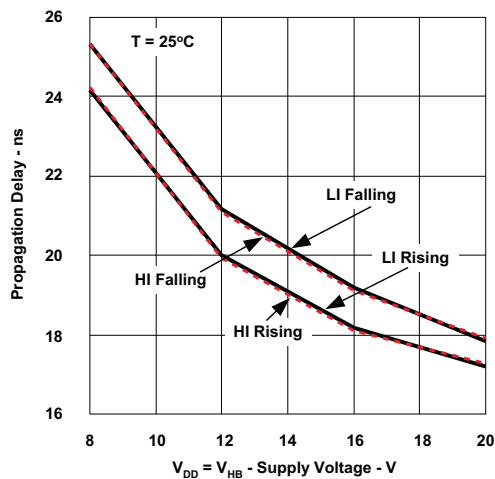

Figure 16. UCC27200 Propagation Delay vs Supply Voltage

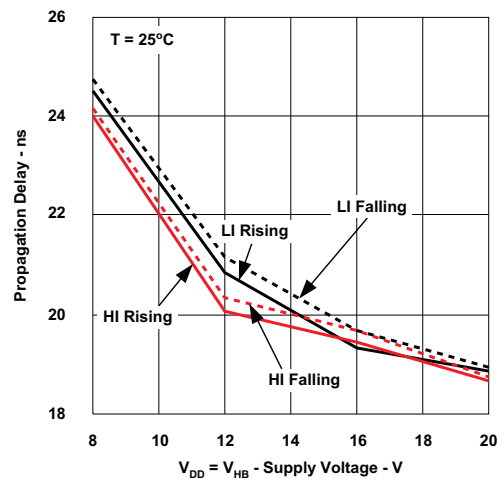

Figure 17. UCC27201 Propagation Delay vs Supply Voltage

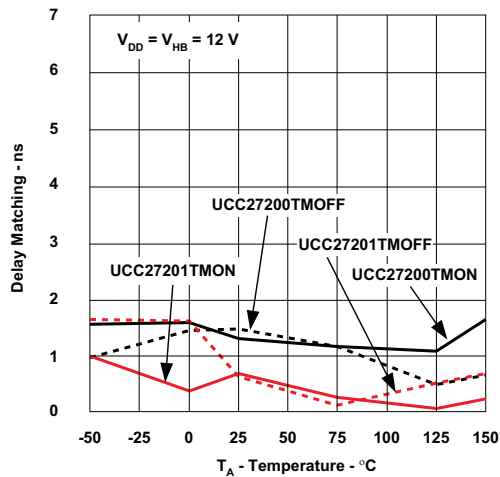

Figure 18. Delay Matching vs Temperature

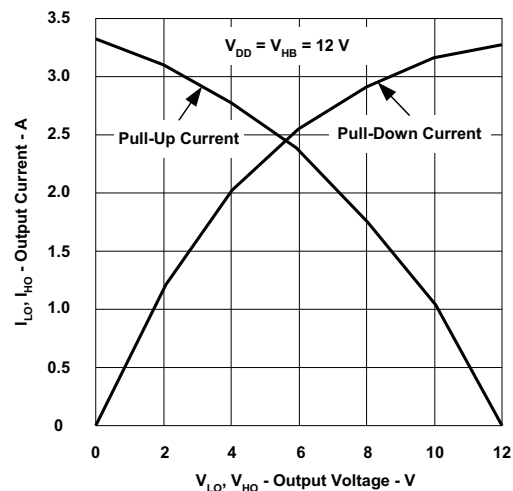
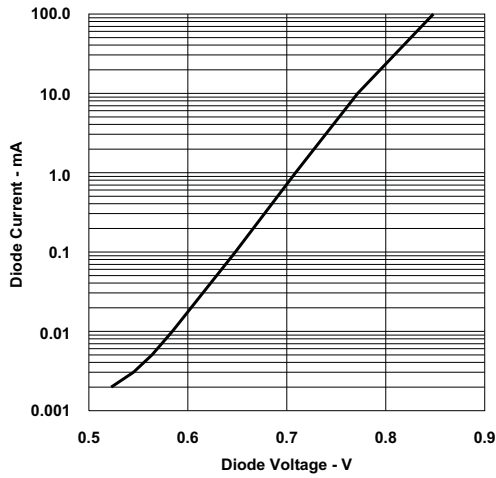
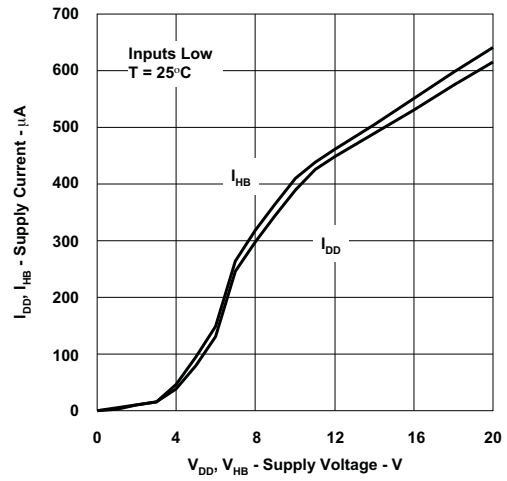

Figure 19. Output Current vs Output Voltage

**Typical Characteristics (continued)**



**Figure 20. Diode Current vs Diode Voltage**



**Figure 21. Quiescent Current vs Supply Voltage**

## 7 Detailed Description

### 7.1 Overview

The UCC27200 and UCC27201 are high-side and low-side drivers. The high-side and low-side each have independent inputs which allow maximum flexibility of input control signals in the application. The boot diode for the high-side driver bias supply is internal to the UCC27200 and UCC27201. The UCC27200 is the CMOS compatible input version and the UCC27201 is the TTL or logic compatible version. The high-side driver is referenced to the switch node (HS) which is typically the source pin of the high-side MOSFET and drain pin of the low-side MOSFET. The low-side driver is referenced to VSS which is typically ground. The functions contained are the input stages, UVLO protection, level shift, boot diode, and output driver stages.

### 7.2 Functional Block Diagram

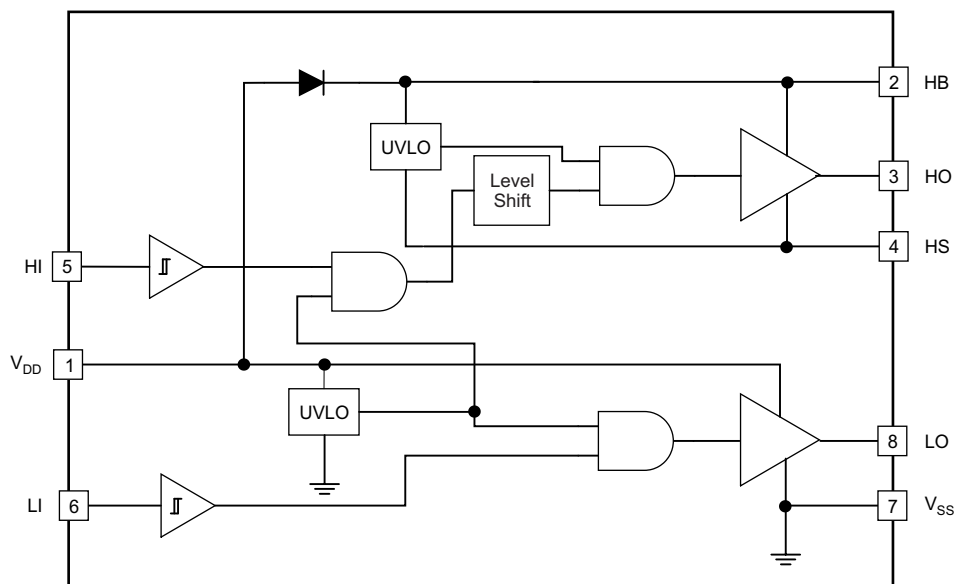

Copyright © 2016, Texas Instruments Incorporated

### 7.3 Feature Description

#### 7.3.1 Input Stages

The input stages provide the interface to the PWM output signals. The input impedance of the UCC27200 is 200-k $\Omega$  nominal and input capacitance is approximately 2 pF. The 200 k $\Omega$  is a pulldown resistance to VSS (ground). The CMOS compatible input of the UCC27200 provides a rising threshold of 48% of VDD and falling threshold of 45% of VDD. The inputs of the UCC27200 are intended to be driven from 0 to VDD levels.

The input stages of the UCC27201 incorporate an open drain configuration to provide the lower input thresholds. The input impedance is 200-k $\Omega$  nominal and input capacitance is approximately 4 pF. The 200 k $\Omega$  is a pulldown resistance to VSS (ground). The logic level compatible input provides a rising threshold of 1.7 V and a falling threshold of 1.6 V.

#### 7.3.2 Undervoltage Lockout (UVLO)

The bias supplies for the high-side and low-side drivers have undervoltage lockout (UVLO) protection. VDD as well as VHB to VHS differential voltages are monitored. The VDD UVLO disables both drivers when VDD is below the specified threshold. The rising VDD threshold is 7.1 V with 0.5-V hysteresis. The VHB UVLO disables only the high-side driver when the VHB to VHS differential voltage is below the specified threshold. The VHB UVLO rising threshold is 6.7 V with 0.4-V hysteresis.

## Feature Description (continued)

### 7.3.3 Level Shift

The level shift circuit is the interface from the high-side input to the high-side driver stage which is referenced to the switch node (HS). The level shift allows control of the HO output referenced to the HS pin and provides excellent delay matching with the low-side driver.

### 7.3.4 Boot Diode

The boot diode necessary to generate the high-side bias is included in the UCC2720x family of drivers. The diode anode is connected to VDD and cathode connected to VHB. With the VHB capacitor connected to HB and the HS pins, the VHB capacitor charge is refreshed every switching cycle when HS transitions to ground. The boot diode provides fast recovery times, low diode resistance, and voltage rating margin to allow for efficient and reliable operation.

### 7.3.5 Output Stages

The output stages are the interface to the power MOSFETs in the power train. High slew rate, low resistance and high peak current capability of both output drivers allow for efficient switching of the power MOSFETs. The low-side output stage is referenced from VDD to VSS and the high-side is referenced from VHB to VHS.

## 7.4 Device Functional Modes

The device operates in normal mode and UVLO mode. See [Undervoltage Lockout \(UVLO\)](#) for more information on UVLO operation mode. In normal mode, the output stage is dependent on the states of the HI and LI pins.

**Table 1. Device Logic Table**

HI PIN	LI PIN	HO <sup>(1)</sup>	LO <sup>(2)</sup>
L	L	L	L
L	H	L	H
H	L	H	L
H	H	H	H

(1) HO is measured with respect to the HS.

(2) LO is measured with respect to the VSS.

## 8 Application and Implementation

---

### NOTE

Information in the following applications sections is not part of the TI component specification, and TI does not warrant its accuracy or completeness. TI's customers are responsible for determining suitability of components for their purposes. Customers should validate and test their design implementation to confirm system functionality.

---

### 8.1 Application Information

To effect fast switching of power devices and reduce associated switching power losses, a powerful gate driver is employed between the PWM output of controllers and the gates of the power semiconductor devices. Also, gate drivers are indispensable when it is impossible for the PWM controller to directly drive the gates of the switching devices. With the advent of digital power, this situation is often encountered because the PWM signal from the digital controller is often a 3.3-V logic signal which cannot effectively turn on a power switch. Level shifting circuitry is needed to boost the 3.3-V signal to the gate-drive voltage (such as 12 V) to fully turn on the power device and minimize conduction losses. Traditional buffer drive circuits based on NPN and PNP bipolar transistors in totem-pole arrangement, being emitter follower configurations, prove inadequate with digital power because they lack level-shifting capability. Gate drivers effectively combine both the level-shifting and buffer-drive functions. Gate drivers also find other needs such as minimizing the effect of high-frequency switching noise by locating the high-current driver physically close to the power switch, driving gate-drive transformers and controlling floating power-device gates, reducing power dissipation and thermal stress in controllers by moving gate charge power losses from the controller into the driver.

## 8.2 Typical Application

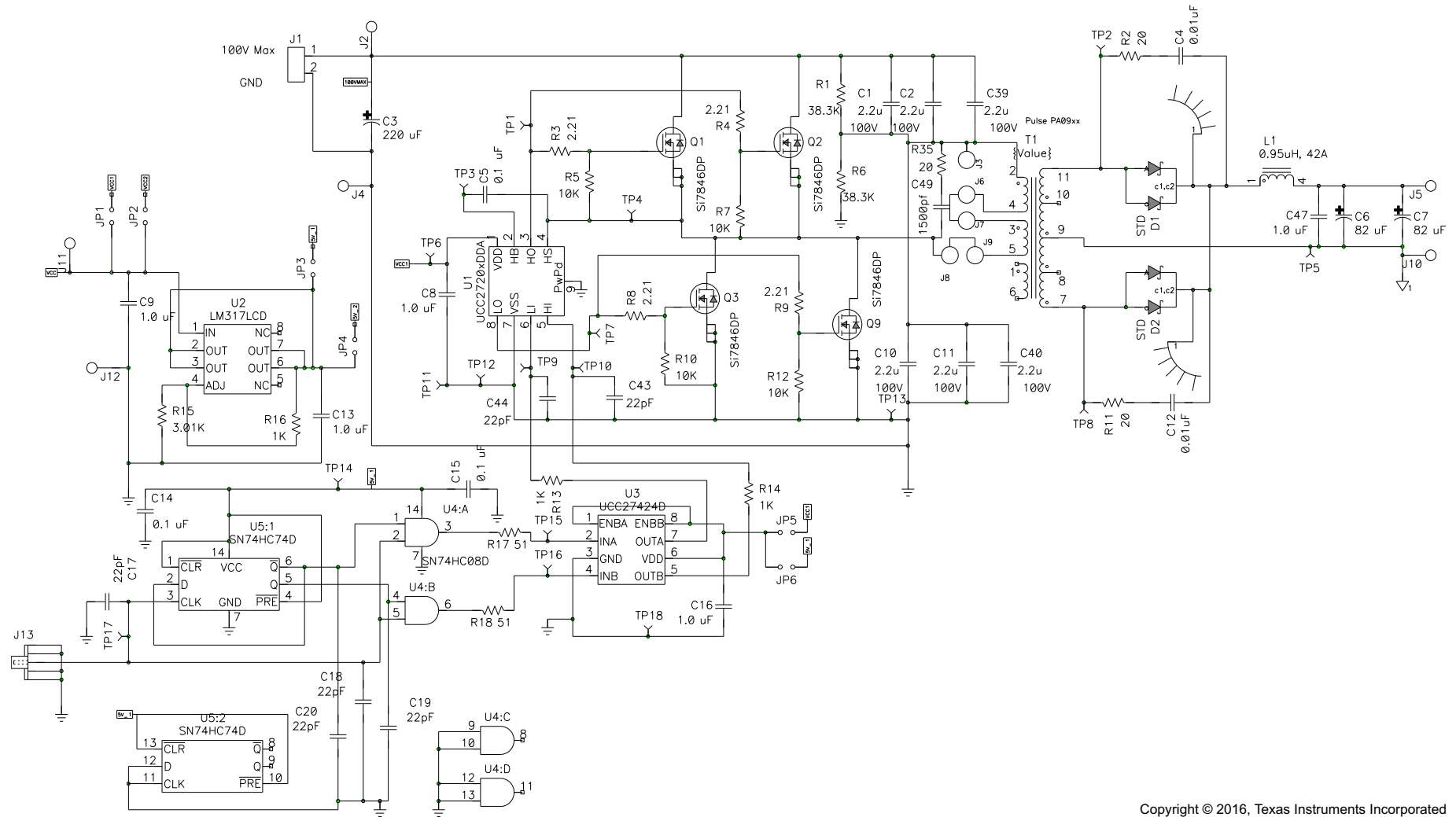

Copyright © 2016, Texas Instruments Incorporated

Figure 22. Open-Loop Half-Bridge Converter

### 8.2.1 Design Requirements

For this design example, use the parameters listed in [Table 2](#).

**Table 2. UCC27201 Design Requirements**

DESIGN PARAMETER	EXAMPLE VALUE
Supply Voltage, VDD	12 V
Voltage on HS, VHS	0 V to 100 V
Voltage on HB, VHB	12 V to 112 V
Output	4 V, 20 A
Frequency	200 kHz

### 8.2.2 Detailed Design Procedure

#### 8.2.2.1 Switching the MOSFETs

Achieving optimum drive performance at high frequency efficiently requires special attention to layout and minimizing parasitic inductances. Take care at the driver die and package level as well as the PCB layout to reduce parasitic inductances as much as possible. [Figure 23](#) shows the main parasitic inductance elements and current flow paths during the turn ON and OFF of the MOSFET by charging and discharging its CGS capacitance.

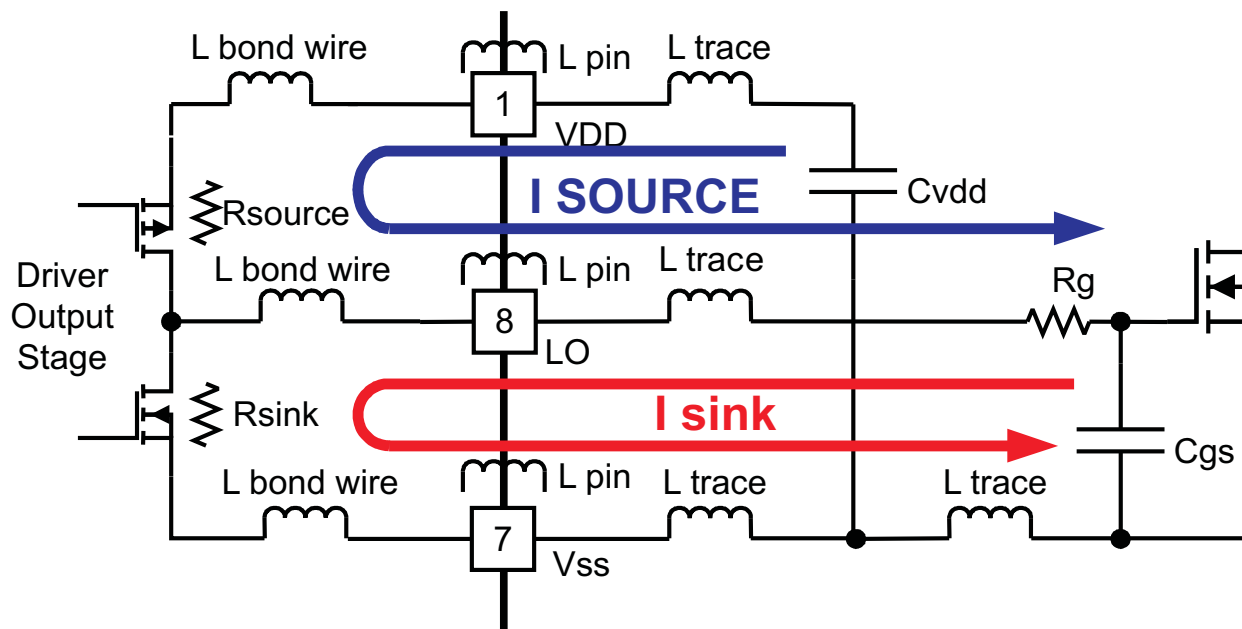

**Figure 23. MOSFET Drive Paths and Circuit Parasitics**

The I<sub>SOURCE</sub> current charges the C<sub>GS</sub> gate capacitor and the I<sub>SINK</sub> current discharges it. The rise and fall time of the voltage across the gate to source defines how quickly the MOSFET can be switched. Based on actual measurements, the analytical curves in [Figure 24](#) and [Figure 25](#) indicate the output voltage and current of the drivers during the discharge of the load capacitor. [Figure 25](#) shows voltage and current as a function of time. [Figure 25](#) indicates the relationship of voltage and current during fast switching. These figures demonstrate the actual switching process and limitations due to parasitic inductances.



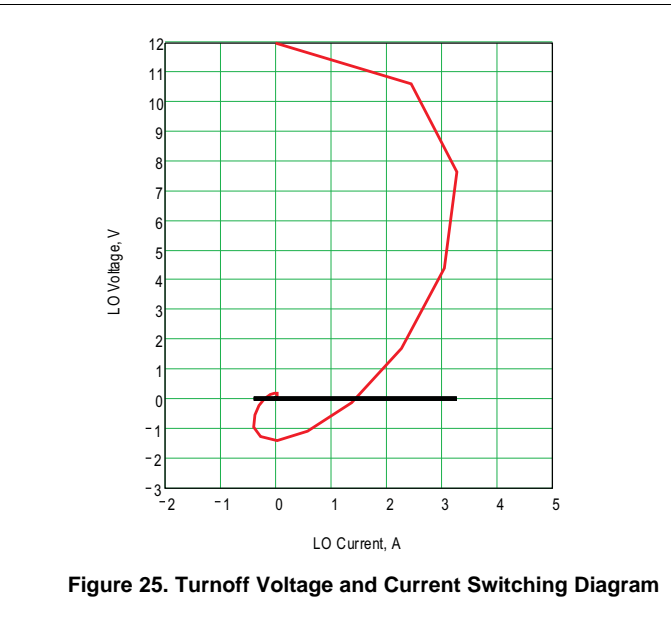
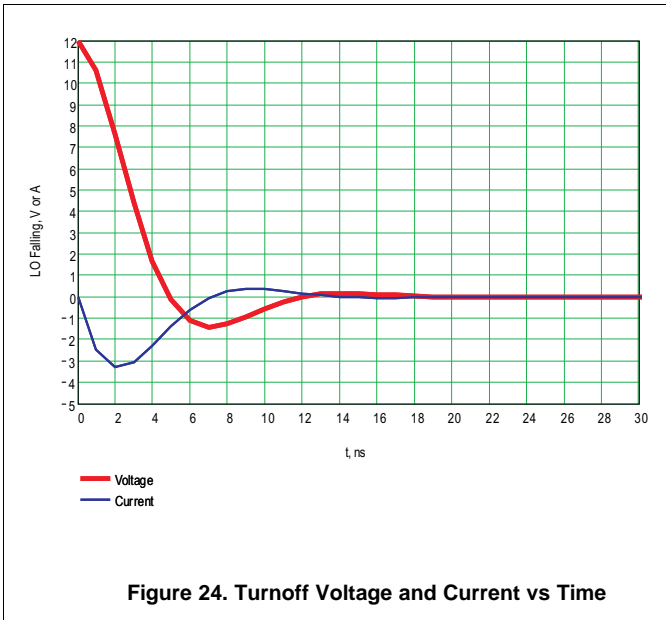

Turning off the MOSFET must be achieved as fast as possible to minimize switching losses. For this reason the UCC2720x drivers are designed for high peak currents and low output resistance. The sink capability is specified as 0.18 V at 100-mA DC current implying 1.8-Ω  $R_{DS(on)}$ . With 12-V drive voltage, no parasitic inductance and a linear resistance, one would expect initial sink current amplitude of 6.7 A for both high-side and low-side drivers. Assuming a pure R-C discharge circuit of the gate capacitor, one would expect the voltage and current waveforms to be exponential. Due to the parasitic inductances and non-linear resistance of the driver MOSFET'S, the actual waveforms have some ringing and the peak-sink current of the drivers is approximately 3.3 A as shown in Figure 19. The overall parasitic inductance of the drive circuit is estimated at 4 nH. The internal parasitic inductance of the 8-pin SOIC package is estimated to be 2 nH including bond wires and leads. The 8-pin VSON package reduces the internal parasitic inductances by more than 50%.

Actual measured waveforms are shown in Figure 26 and Figure 27. As shown, the typical rise time of 8 ns and fall time of 7 ns is conservatively rated.

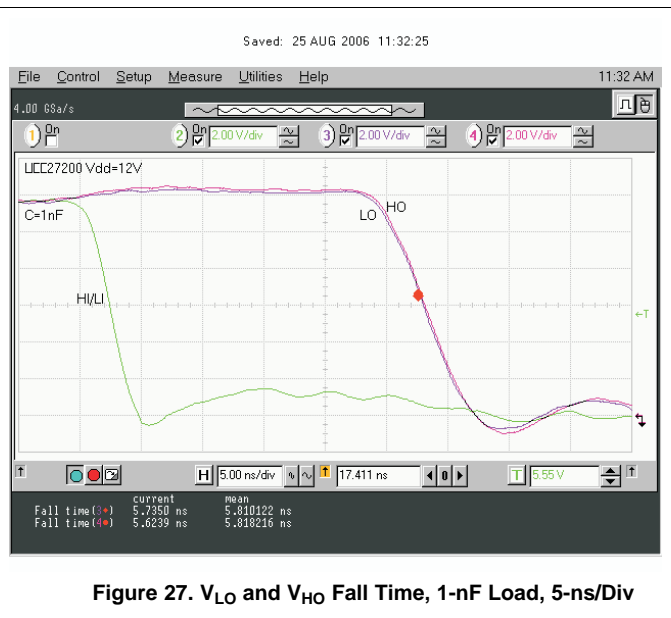
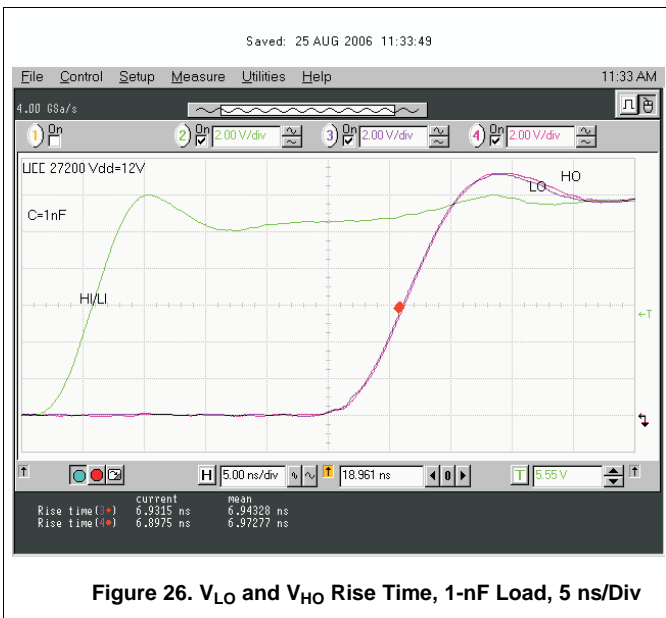

### 8.2.2.2 Dynamic Switching of the MOSFETs

The true behavior of MOSFETs presents a dynamic capacitive load primarily at the gate to source threshold voltage. Using the turnoff case as the example, when the gate to source threshold voltage is reached the drain voltage starts rising, the drain to gate parasitic capacitance couples charge into the gate resulting in the turnoff plateau. The relatively low threshold voltages of many MOSFETs and the increased charge that has to be removed (Miller charge) makes good driver performance necessary for efficient switching. An open-loop half bridge power converter was used to evaluate performance in actual applications. The schematic of the half-bridge converter is shown in Figure 22. The turnoff waveforms of the UCC27200 driving two MOSFETs in parallel is shown in Figure 28 and Figure 29.

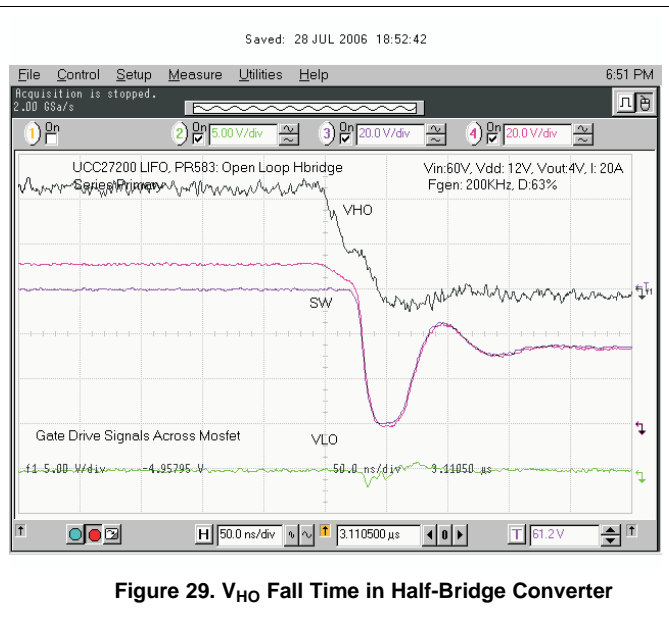
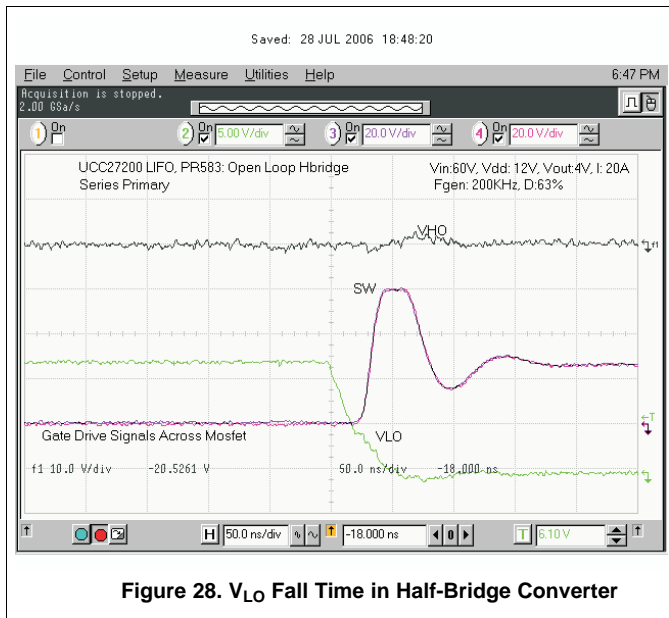

#### 8.2.2.2.1 Delay Matching and Narrow Pulse Widths

The total delays encountered in the PWM, driver and power stage must be considered for a number of reasons, primarily delay in current limit response. Also to be considered are differences in delays between the drivers which can lead to various concerns depending on the topology. The sync-buck topology switching requires careful selection of dead time between the high-side and low-side switches to avoid cross conduction and excessive body diode conduction. Bridge topologies can be affected by a resulting V/s imbalance on the transformer if there is imbalance in the high and low-side pulse widths in a steady state condition.

Narrow pulse width performance is an important consideration when transient and short circuit conditions are encountered. Although there may be relatively long steady state PWM output-driver-MOSFET signals, very narrow pulses may be encountered in soft start, large load transients, and short-circuit conditions.

The UCC2720x driver family offers excellent performance regarding high and low-side driver delay matching and narrow pulse width performance. The delay matching waveforms are shown in Figure 30 and Figure 31. The UCC2720x driver narrow pulse performance is shown in Figure 32 and Figure 33.

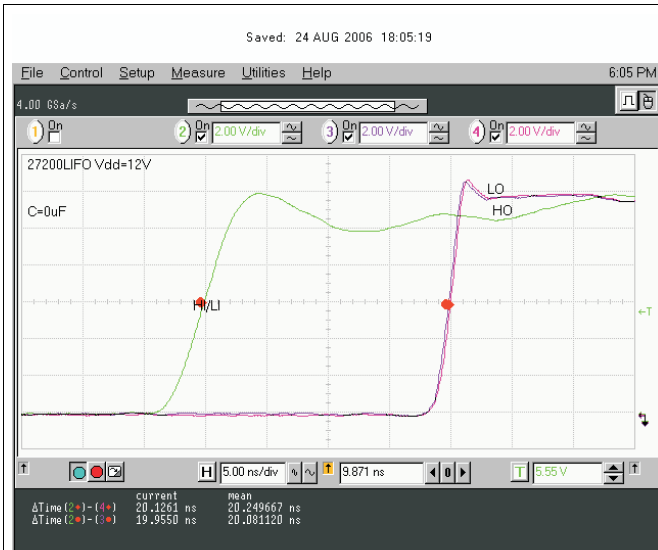

Figure 30.  $V_{LO}$  and  $V_{HO}$  Rising Edge Delay Matching



Figure 31.  $V_{LO}$  and  $V_{HO}$  Falling Edge Delay Matching



Figure 32. 20-ns Input Pulse Delay Matching

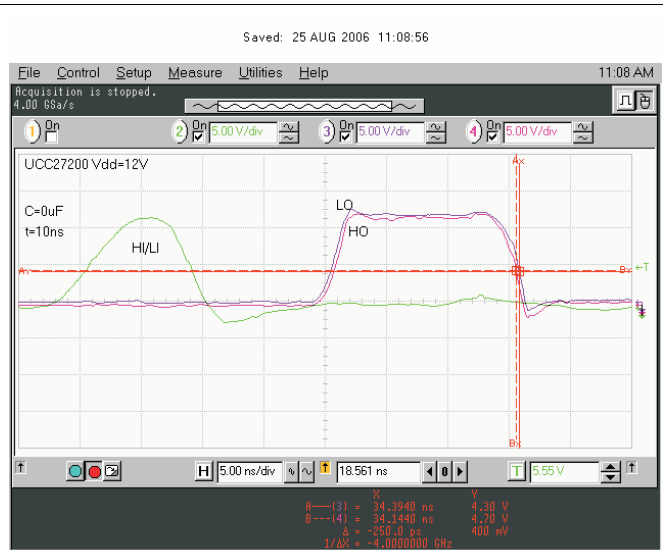

Figure 33. 10-ns Input Pulse Delay Matching

### 8.2.2.3 Boot Diode Performance

The UCC2720x family of drivers incorporates the bootstrap diode necessary to generate the high-side bias internally. The characteristics of this diode are important to achieve efficient, reliable operation. The DC characteristics to consider are  $V_F$  and dynamic resistance. A low  $V_F$  and high dynamic resistance results in a high forward voltage during charging of the bootstrap capacitor. The UCC2720x has a boot diode rated at 0.65-V  $V_F$  and dynamic resistance of 0.6  $\Omega$  for reliable charge transfer to the bootstrap capacitor. The dynamic characteristics to consider are diode recovery time and stored charge. Diode recovery times that are specified with no conditions can be misleading. Diode recovery times at no forward current ( $I_F$ ) can be noticeably less than with forward current applied. The UCC2720x boot diode recovery is specified at 20 ns at  $I_F = 20$  mA,  $I_{REV} = 0.5$  A. At 0-mA  $I_F$  the reverse recovery time is 15 ns.

Another less obvious consideration is how the stored charge of the diode is affected by applied voltage. On every switching transition when the HS node transitions from low to high, charge is removed from the boot capacitor to charge the capacitance of the reverse biased diode. This is a portion of the driver power losses and reduces the voltage on the HB capacitor. At higher applied voltages, the stored charge of the UCC2720x PN diode is often less than a comparable Schottky diode.

### 8.2.3 Application Curves

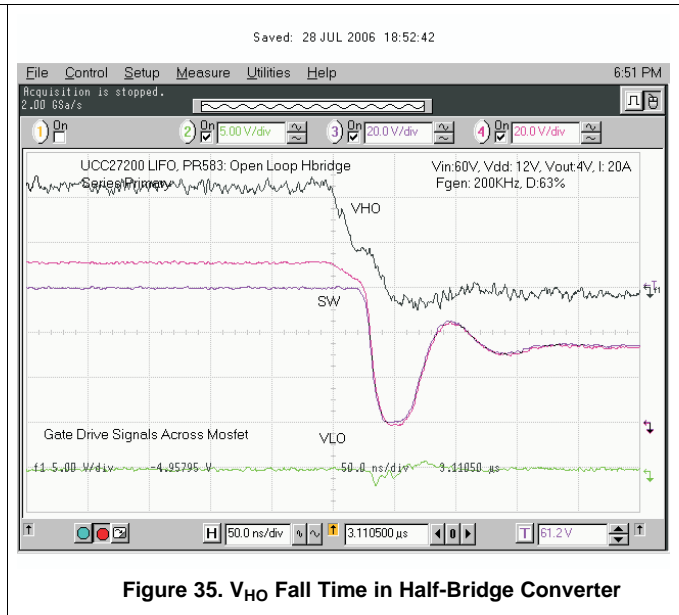
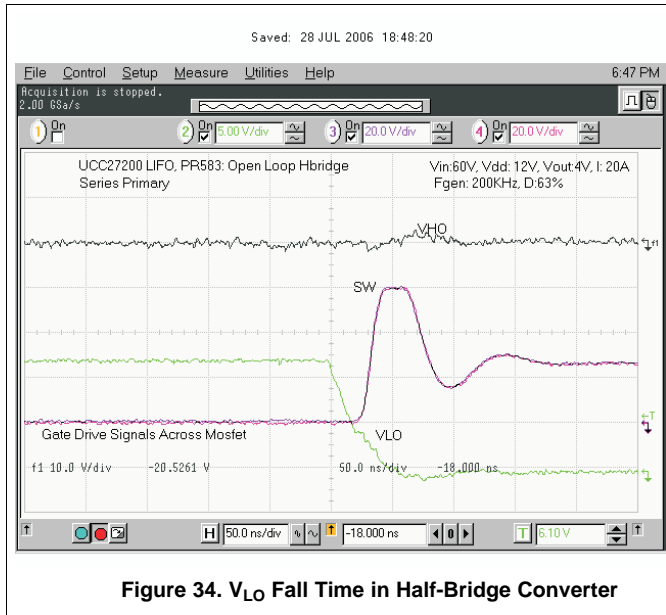

## 9 Power Supply Recommendations

The bias supply voltage range for which the device is rated to operate is from 8 V to 17 V. The lower end of this range is governed by the internal UVLO protection feature on the VDD pin supply circuit blocks. Whenever the driver is in UVLO condition when the VDD pin voltage is below the  $V(ON)$  supply start threshold, this feature holds the output low, regardless of the status of the inputs. The upper end of this range is driven by the 20-V absolute maximum voltage rating of the VDD pin of the device (which is a stress rating). Keeping a 3-V margin to allow for transient voltage spikes, the maximum voltage for the VDD pin is 17 V. The UVLO protection feature also involves a hysteresis function. This means that when the VDD pin bias voltage has exceeded the threshold voltage and device begins to operate, and if the voltage drops, then the device continues to deliver normal functionality unless the voltage drop exceeds the hysteresis specification  $VDD(hys)$ . Therefore, ensuring that, while operating at or near the 8-V range, the voltage ripple on the auxiliary power supply output is smaller than the hysteresis specification of the device is important to avoid triggering device shutdown. During system shutdown, the device operation continues until the VDD pin voltage has dropped below the  $V(OFF)$  threshold which must be accounted for while evaluating system shutdown timing design requirements. Likewise, at system start-up, the device does not begin operation until the VDD pin voltage has exceeded above the  $V(ON)$  threshold. The quiescent current consumed by the internal circuit blocks of the device is supplied through the VDD pin. Although this fact is well known, recognizing that the charge for source current pulses delivered by the HO pin is also supplied through the same VDD pin is important. As a result, every time a current is sourced out of the HO pin a corresponding current pulse is delivered into the device through the VDD pin. Thus ensuring that a local bypass capacitor is provided between the VDD and GND pins and located as close to the device as possible for the purpose of decoupling is important. A low ESR, ceramic surface mount capacitor is a must. TI recommends using a capacitor in the range of 0.22  $\mu F$  to 4.7  $\mu F$  between VDD and GND. In a similar manner, the current pulses delivered by the LO pin are sourced from the HB pin. Therefore, TI recommends a 0.022- $\mu F$  to 0.1- $\mu F$  local decoupling capacitor between the HB and HS pins.

## 10 Layout

### 10.1 Layout Guidelines

To improve the switching characteristics and efficiency of a design, the following layout rules must be followed.

- Place the driver as close as possible to the MOSFETs.
- Place the  $V_{DD}$  and  $V_{HB}$  (bootstrap) capacitors as close as possible to the driver.
- Pay close attention to the GND trace. Use the thermal pad of the DDA and DRM package as GND by connecting it to the VSS pin (GND). The GND trace from the driver goes directly to the source of the MOSFET but must not be in the high current path of the MOSFET(s) drain or source current.
- Use similar rules for the HS node as for GND for the high-side driver.
- Use wide traces for LO and HO closely following the associated GND or HS traces. 60-mil to 100-mil width is preferable where possible.
- Use as least two or more vias if the driver outputs or SW node must be routed from one layer to another. For GND the number of vias must be a consideration of the thermal pad requirements as well as parasitic inductance.
- Avoid  $L_I$  and  $H_I$  (driver input) going close to the HS node or any other high  $dV/dT$  traces that can induce significant noise into the relatively high impedance leads.
- Keep in mind that a poor layout can cause a significant drop in efficiency versus a good PCB layout and can even lead to decreased reliability of the whole system.

### 10.2 Layout Example

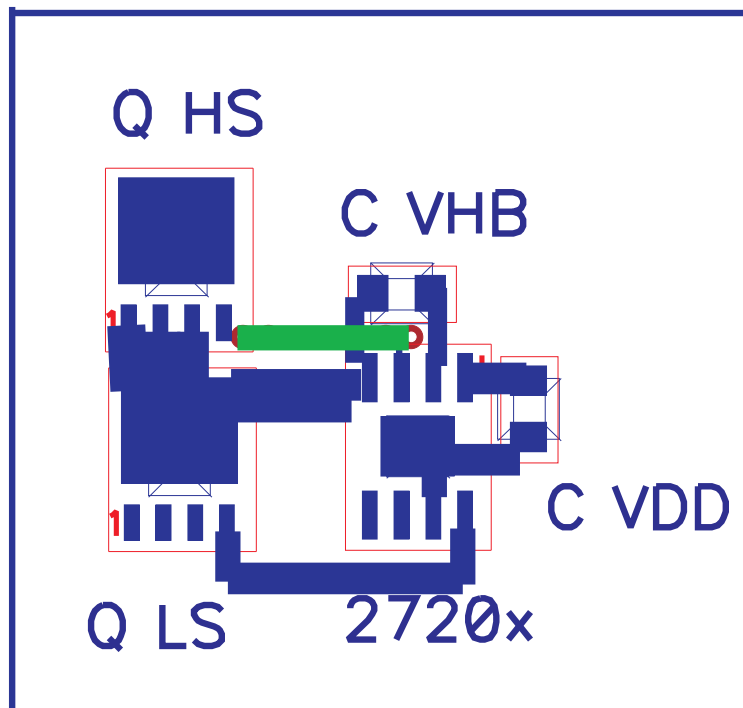

Figure 36. Example Component Placement

## 11 Device and Documentation Support

### 11.1 Documentation Support

#### 11.1.1 Related Documentation

For related documentation see the following:

- *QFN/SON PCB Attachment*, [SLUA271](#)
- *PowerPAD Thermally Enhanced Package*, [SLMA002](#)
- *PowerPAD Made Easy*, [SLMA004](#)

### 11.2 Related Links

The table below lists quick access links. Categories include technical documents, support and community resources, tools and software, and quick access to sample or buy.

**Table 3. Related Links**

PARTS	PRODUCT FOLDER	SAMPLE & BUY	TECHNICAL DOCUMENTS	TOOLS & SOFTWARE	SUPPORT & COMMUNITY
UCC27200	<a href="#">Click here</a>	<a href="#">Click here</a>	<a href="#">Click here</a>	<a href="#">Click here</a>	<a href="#">Click here</a>
UCC27201	<a href="#">Click here</a>	<a href="#">Click here</a>	<a href="#">Click here</a>	<a href="#">Click here</a>	<a href="#">Click here</a>

### 11.3 Community Resources

The following links connect to TI community resources. Linked contents are provided "AS IS" by the respective contributors. They do not constitute TI specifications and do not necessarily reflect TI's views; see TI's [Terms of Use](#).

**TI E2E™ Online Community** *TI's Engineer-to-Engineer (E2E) Community*. Created to foster collaboration among engineers. At [e2e.ti.com](http://e2e.ti.com), you can ask questions, share knowledge, explore ideas and help solve problems with fellow engineers.

**Design Support** *TI's Design Support* Quickly find helpful E2E forums along with design support tools and contact information for technical support.

### 11.4 Trademarks

PowerPAD, E2E are trademarks of Texas Instruments.  
All other trademarks are the property of their respective owners.

### 11.5 Electrostatic Discharge Caution



This integrated circuit can be damaged by ESD. Texas Instruments recommends that all integrated circuits be handled with appropriate precautions. Failure to observe proper handling and installation procedures can cause damage.

ESD damage can range from subtle performance degradation to complete device failure. Precision integrated circuits may be more susceptible to damage because very small parametric changes could cause the device not to meet its published specifications.

### 11.6 Glossary

[SLYZ022](#) — *TI Glossary*.

This glossary lists and explains terms, acronyms, and definitions.

## 12 Mechanical, Packaging, and Orderable Information

The following pages include mechanical, packaging, and orderable information. This information is the most current data available for the designated devices. This data is subject to change without notice and revision of this document. For browser-based versions of this data sheet, refer to the left-hand navigation.

**PACKAGING INFORMATION**

Orderable Device	Status (1)	Package Type	Package Drawing	Pins	Package Qty	Eco Plan (2)	Lead/Ball Finish (6)	MSL Peak Temp (3)	Op Temp (°C)	Device Marking (4/5)	Samples
UCC27200D	ACTIVE	SOIC	D	8	75	Green (RoHS & no Sb/Br)	CU NIPDAU	Level-1-260C-UNLIM	-40 to 140	27200	<a href="#">Samples</a>
UCC27200DDA	ACTIVE	SO PowerPAD	DDA	8	75	Green (RoHS & no Sb/Br)	CU NIPDAU   CU NIPDAUAG	Level-1-260C-UNLIM	-40 to 140	27200	<a href="#">Samples</a>
UCC27200DDAR	ACTIVE	SO PowerPAD	DDA	8	2500	Green (RoHS & no Sb/Br)	CU NIPDAU   CU NIPDAUAG	Level-1-260C-UNLIM	-40 to 140	27200	<a href="#">Samples</a>
UCC27200DR	ACTIVE	SOIC	D	8	2500	Green (RoHS & no Sb/Br)	CU NIPDAU	Level-1-260C-UNLIM	-40 to 140	27200	<a href="#">Samples</a>
UCC27200DRMR	ACTIVE	VSON	DRM	8	3000	Green (RoHS & no Sb/Br)	CU NIPDAUAG	Level-2-260C-1 YEAR	-40 to 140	27200	<a href="#">Samples</a>
UCC27200DRMT	ACTIVE	VSON	DRM	8	250	Green (RoHS & no Sb/Br)	CU NIPDAUAG	Level-2-260C-1 YEAR	-40 to 140	27200	<a href="#">Samples</a>
UCC27201D	ACTIVE	SOIC	D	8	75	Green (RoHS & no Sb/Br)	CU NIPDAU	Level-1-260C-UNLIM	-40 to 140	27201	<a href="#">Samples</a>
UCC27201DDA	ACTIVE	SO PowerPAD	DDA	8	75	Green (RoHS & no Sb/Br)	CU NIPDAU   CU NIPDAUAG	Level-1-260C-UNLIM	-40 to 140	27201	<a href="#">Samples</a>
UCC27201DDAR	ACTIVE	SO PowerPAD	DDA	8	2500	Green (RoHS & no Sb/Br)	CU NIPDAU   CU NIPDAUAG	Level-1-260C-UNLIM	-40 to 140	27201	<a href="#">Samples</a>
UCC27201DR	ACTIVE	SOIC	D	8	2500	Green (RoHS & no Sb/Br)	CU NIPDAU	Level-1-260C-UNLIM	-40 to 140	27201	<a href="#">Samples</a>
UCC27201DRMR	ACTIVE	VSON	DRM	8	3000	Green (RoHS & no Sb/Br)	CU NIPDAU   CU NIPDAUAG	Level-1-260C-UNLIM	-40 to 140	27201	<a href="#">Samples</a>
UCC27201DRMT	ACTIVE	VSON	DRM	8	250	Green (RoHS & no Sb/Br)	CU NIPDAU   CU NIPDAUAG	Level-1-260C-UNLIM	-40 to 140	27201	<a href="#">Samples</a>

(1) The marketing status values are defined as follows:

**ACTIVE:** Product device recommended for new designs.

**LIFEBUY:** TI has announced that the device will be discontinued, and a lifetime-buy period is in effect.

**NRND:** Not recommended for new designs. Device is in production to support existing customers, but TI does not recommend using this part in a new design.

**PREVIEW:** Device has been announced but is not in production. Samples may or may not be available.

**OBSELETE:** TI has discontinued the production of the device.

(2) **RoHS:** TI defines "RoHS" to mean semiconductor products that are compliant with the current EU RoHS requirements for all 10 RoHS substances, including the requirement that RoHS substance do not exceed 0.1% by weight in homogeneous materials. Where designed to be soldered at high temperatures, "RoHS" products are suitable for use in specified lead-free processes. TI may reference these types of products as "Pb-Free".

**RoHS Exempt:** TI defines "RoHS Exempt" to mean products that contain lead but are compliant with EU RoHS pursuant to a specific EU RoHS exemption.

---

**Green:** TI defines "Green" to mean the content of Chlorine (Cl) and Bromine (Br) based flame retardants meet JS709B low halogen requirements of  $\leq 1000$ ppm threshold. Antimony trioxide based flame retardants must also meet the  $\leq 1000$ ppm threshold requirement.

(3) MSL, Peak Temp. - The Moisture Sensitivity Level rating according to the JEDEC industry standard classifications, and peak solder temperature.

(4) There may be additional marking, which relates to the logo, the lot trace code information, or the environmental category on the device.

(5) Multiple Device Markings will be inside parentheses. Only one Device Marking contained in parentheses and separated by a "~" will appear on a device. If a line is indented then it is a continuation of the previous line and the two combined represent the entire Device Marking for that device.

(6) Lead/Ball Finish - Orderable Devices may have multiple material finish options. Finish options are separated by a vertical ruled line. Lead/Ball Finish values may wrap to two lines if the finish value exceeds the maximum column width.

**Important Information and Disclaimer:** The information provided on this page represents TI's knowledge and belief as of the date that it is provided. TI bases its knowledge and belief on information provided by third parties, and makes no representation or warranty as to the accuracy of such information. Efforts are underway to better integrate information from third parties. TI has taken and continues to take reasonable steps to provide representative and accurate information but may not have conducted destructive testing or chemical analysis on incoming materials and chemicals. TI and TI suppliers consider certain information to be proprietary, and thus CAS numbers and other limited information may not be available for release.

In no event shall TI's liability arising out of such information exceed the total purchase price of the TI part(s) at issue in this document sold by TI to Customer on an annual basis.

**OTHER QUALIFIED VERSIONS OF UCC27200 :**

- Automotive: [UCC27200-Q1](#)

NOTE: Qualified Version Definitions:

- Automotive - Q100 devices qualified for high-reliability automotive applications targeting zero defects



## TAPE AND REEL INFORMATION



### QUADRANT ASSIGNMENTS FOR PIN 1 ORIENTATION IN TAPE



\*All dimensions are nominal

Device	Package Type	Package Drawing	Pins	SPQ	Reel Diameter (mm)	Reel Width W1 (mm)	A0 (mm)	B0 (mm)	K0 (mm)	P1 (mm)	W (mm)	Pin1 Quadrant
UCC27200DDAR	SO Power PAD	DDA	8	2500	330.0	12.8	6.4	5.2	2.1	8.0	12.0	Q1
UCC27200DR	SOIC	D	8	2500	330.0	12.4	6.4	5.2	2.1	8.0	12.0	Q1
UCC27200DRMR	VSON	DRM	8	3000	330.0	12.4	4.25	4.25	1.15	8.0	12.0	Q2
UCC27200DRMT	VSON	DRM	8	250	180.0	12.4	4.25	4.25	1.15	8.0	12.0	Q2
UCC27201DDAR	SO Power PAD	DDA	8	2500	330.0	12.8	6.4	5.2	2.1	8.0	12.0	Q1
UCC27201DR	SOIC	D	8	2500	330.0	12.4	6.4	5.2	2.1	8.0	12.0	Q1
UCC27201DRMR	VSON	DRM	8	3000	330.0	12.4	4.25	4.25	1.15	8.0	12.0	Q2
UCC27201DRMR	VSON	DRM	8	3000	330.0	12.4	4.25	4.25	1.15	8.0	12.0	Q2
UCC27201DRMT	VSON	DRM	8	250	180.0	12.4	4.25	4.25	1.15	8.0	12.0	Q2
UCC27201DRMT	VSON	DRM	8	250	180.0	12.4	4.25	4.25	1.15	8.0	12.0	Q2

**TAPE AND REEL BOX DIMENSIONS**

\*All dimensions are nominal

Device	Package Type	Package Drawing	Pins	SPQ	Length (mm)	Width (mm)	Height (mm)
UCC27200DDAR	SO PowerPAD	DDA	8	2500	364.0	364.0	27.0
UCC27200DR	SOIC	D	8	2500	340.5	338.1	20.6
UCC27200DRMR	VSON	DRM	8	3000	367.0	367.0	35.0
UCC27200DRMT	VSON	DRM	8	250	210.0	185.0	35.0
UCC27201DDAR	SO PowerPAD	DDA	8	2500	364.0	364.0	27.0
UCC27201DR	SOIC	D	8	2500	340.5	338.1	20.6
UCC27201DRMR	VSON	DRM	8	3000	367.0	367.0	35.0
UCC27201DRMR	VSON	DRM	8	3000	367.0	367.0	35.0
UCC27201DRMT	VSON	DRM	8	250	210.0	185.0	35.0
UCC27201DRMT	VSON	DRM	8	250	210.0	185.0	35.0

DRM (S-PVSON-N8)

PLASTIC SMALL OUTLINE NO-LEAD



4205854/C 02/11

- NOTES:
- A. All linear dimensions are in millimeters. Dimensioning and tolerancing per ASME Y14.5M-1994.
  - B. This drawing is subject to change without notice.
  - C. SON (Small Outline No-Lead) package configuration.
  -  The package thermal pad must be soldered to the board for thermal and mechanical performance. See the Product Data Sheet for details regarding the exposed thermal pad dimensions.

### THERMAL INFORMATION

This package incorporates an exposed thermal pad that is designed to be attached directly to an external heatsink. The thermal pad must be soldered directly to the printed circuit board (PCB). After soldering, the PCB can be used as a heatsink. In addition, through the use of thermal vias, the thermal pad can be attached directly to the appropriate copper plane shown in the electrical schematic for the device, or alternatively, can be attached to a special heatsink structure designed into the PCB. This design optimizes the heat transfer from the integrated circuit (IC).

For information on the Quad Flatpack No-Lead (QFN) package and its advantages, refer to Application Report, Quad Flatpack No-Lead Logic Packages, Texas Instruments Literature No. SCBA017. This document is available at [www.ti.com](http://www.ti.com).

The exposed thermal pad dimensions for this package are shown in the following illustration.



NOTE: All linear dimensions are in millimeters

Exposed Thermal Pad Dimensions

DRM (S-PDSO-N8)

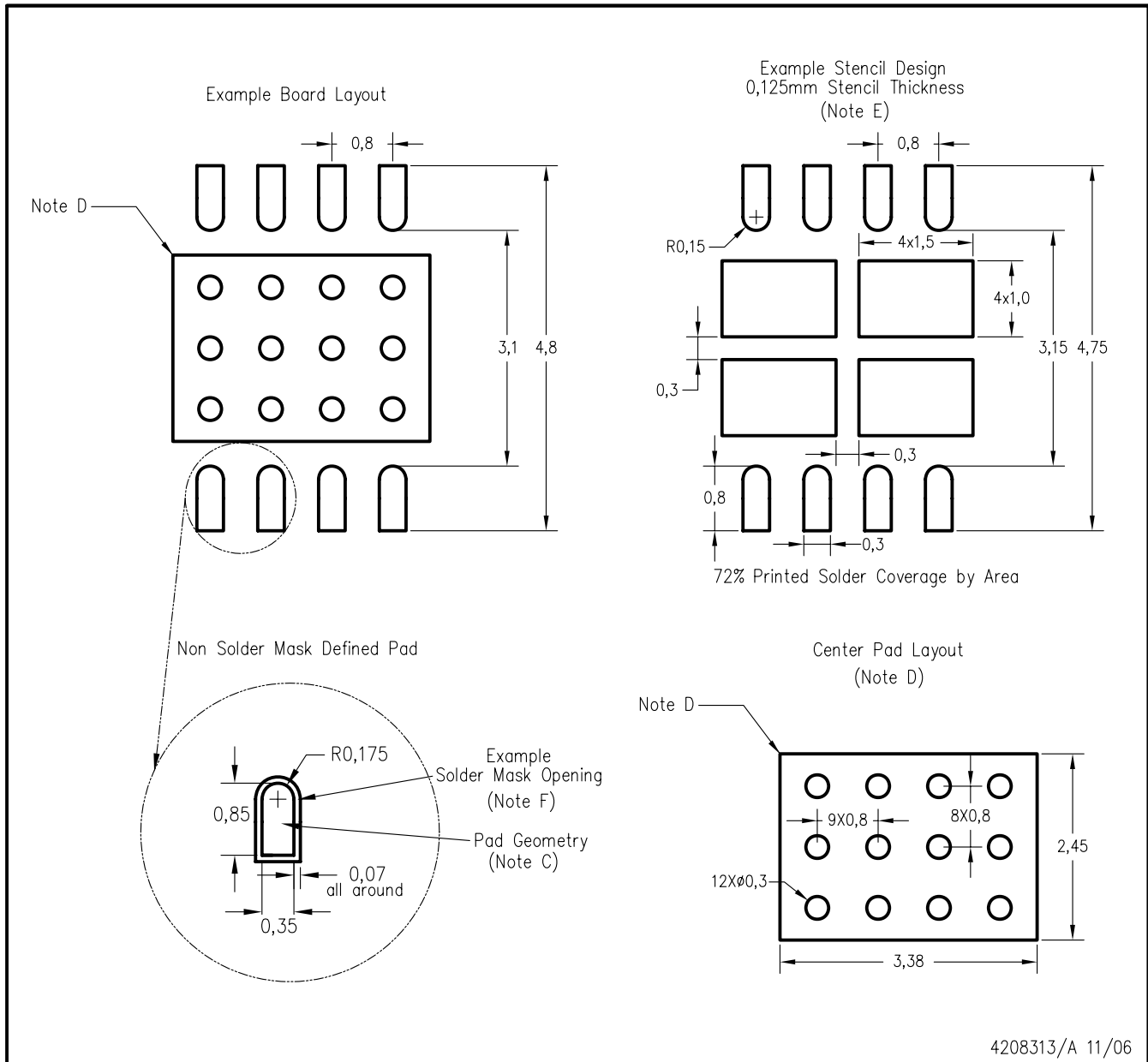

4208313/A 11/06

- NOTES:
- A. All linear dimensions are in millimeters.
  - B. This drawing is subject to change without notice.
  - C. Publication IPC-7351 is recommended for alternate designs.
  - D. This package is designed to be soldered to a thermal pad on the board. Refer to Application Note, QFN Packages, Texas Instruments Literature No. SCBA017, SLUA271, and also the Product Data Sheets for specific thermal information, via requirements, and recommended board layout. These documents are available at [www.ti.com](http://www.ti.com) <<http://www.ti.com>>.
  - E. Laser cutting apertures with trapezoidal walls and also rounding corners will offer better paste release. Customers should contact their board assembly site for stencil design recommendations. Refer to IPC 7525 for stencil design considerations.
  - F. Customers should contact their board fabrication site for solder mask tolerances.



D0008A

# PACKAGE OUTLINE

SOIC - 1.75 mm max height

SMALL OUTLINE INTEGRATED CIRCUIT



4214825/C 02/2019

NOTES:

1. Linear dimensions are in inches [millimeters]. Dimensions in parenthesis are for reference only. Controlling dimensions are in inches. Dimensioning and tolerancing per ASME Y14.5M.
2. This drawing is subject to change without notice.
3. This dimension does not include mold flash, protrusions, or gate burrs. Mold flash, protrusions, or gate burrs shall not exceed .006 [0.15] per side.
4. This dimension does not include interlead flash.
5. Reference JEDEC registration MS-012, variation AA.

# EXAMPLE BOARD LAYOUT

D0008A

SOIC - 1.75 mm max height

SMALL OUTLINE INTEGRATED CIRCUIT



LAND PATTERN EXAMPLE  
 EXPOSED METAL SHOWN  
 SCALE:8X



SOLDER MASK DETAILS

4214825/C 02/2019

NOTES: (continued)

- 6. Publication IPC-7351 may have alternate designs.
- 7. Solder mask tolerances between and around signal pads can vary based on board fabrication site.

# EXAMPLE STENCIL DESIGN

D0008A

SOIC - 1.75 mm max height

SMALL OUTLINE INTEGRATED CIRCUIT



SOLDER PASTE EXAMPLE  
BASED ON .005 INCH [0.125 MM] THICK STENCIL  
SCALE:8X

4214825/C 02/2019

NOTES: (continued)

8. Laser cutting apertures with trapezoidal walls and rounded corners may offer better paste release. IPC-7525 may have alternate design recommendations.
9. Board assembly site may have different recommendations for stencil design.





Images above are just a representation of the package family, actual package may vary.  
Refer to the product data sheet for package details.

DDA (R-PDSO-G8)

PowerPAD™ PLASTIC SMALL-OUTLINE



4202561/F 12/11

- NOTES:
- All linear dimensions are in millimeters. Dimensioning and tolerancing per ASME Y14.5-1994.
  - This drawing is subject to change without notice.
  - Body dimensions do not include mold flash or protrusion not to exceed 0,15.
  - This package is designed to be soldered to a thermal pad on the board. Refer to Technical Brief, PowerPad Thermally Enhanced Package, Texas Instruments Literature No. SLMA002 for information regarding recommended board layout. This document is available at [www.ti.com](http://www.ti.com) <<http://www.ti.com>>.
  - See the additional figure in the Product Data Sheet for details regarding the exposed thermal pad features and dimensions.
  - This package complies to JEDEC MS-012 variation BA

PowerPAD is a trademark of Texas Instruments.

DDA (R-PDSO-G8)

PowerPAD™ PLASTIC SMALL OUTLINE

## THERMAL INFORMATION

This PowerPAD™ package incorporates an exposed thermal pad that is designed to be attached to a printed circuit board (PCB). The thermal pad must be soldered directly to the PCB. After soldering, the PCB can be used as a heatsink. In addition, through the use of thermal vias, the thermal pad can be attached directly to the appropriate copper plane shown in the electrical schematic for the device, or alternatively, can be attached to a special heatsink structure designed into the PCB. This design optimizes the heat transfer from the integrated circuit (IC).

For additional information on the PowerPAD package and how to take advantage of its heat dissipating abilities, refer to Technical Brief, PowerPAD Thermally Enhanced Package, Texas Instruments Literature No. SLMA002 and Application Brief, PowerPAD Made Easy, Texas Instruments Literature No. SLMA004. Both documents are available at [www.ti.com](http://www.ti.com).

The exposed thermal pad dimensions for this package are shown in the following illustration.

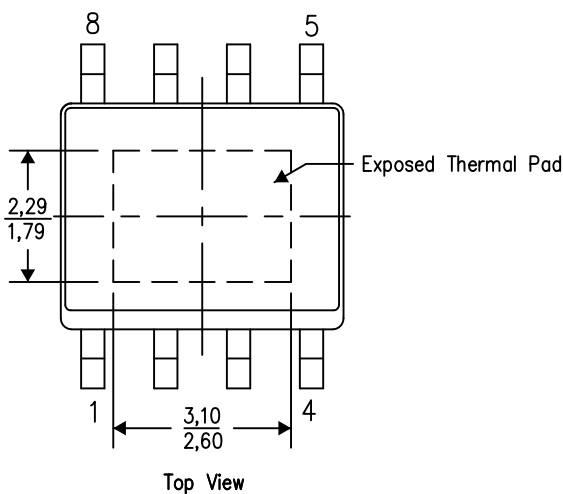

Exposed Thermal Pad Dimensions

4206322-8/L 05/12

NOTE: A. All linear dimensions are in millimeters

PowerPAD is a trademark of Texas Instruments

DDA (R-PDSO-G8)

PowerPAD™ PLASTIC SMALL-OUTLINE



- NOTES:
- A. All linear dimensions are in millimeters. Dimensioning and tolerancing per ASME Y14.5-1994.
  - B. This drawing is subject to change without notice.
  - C. Body dimensions do not include mold flash or protrusion not to exceed 0,15.
  - D. This package is designed to be soldered to a thermal pad on the board. Refer to Technical Brief, PowerPad Thermally Enhanced Package, Texas Instruments Literature No. SLMA002 for information regarding recommended board layout. This document is available at [www.ti.com](http://www.ti.com) <<http://www.ti.com>>.
  - E. See the additional figure in the Product Data Sheet for details regarding the exposed thermal pad features and dimensions.
  - F. This package complies to JEDEC MS-012 variation BA

PowerPAD is a trademark of Texas Instruments.

DDA (R-PDSO-G8)

PowerPAD™ PLASTIC SMALL OUTLINE

## THERMAL INFORMATION

This PowerPAD™ package incorporates an exposed thermal pad that is designed to be attached to a printed circuit board (PCB). The thermal pad must be soldered directly to the PCB. After soldering, the PCB can be used as a heatsink. In addition, through the use of thermal vias, the thermal pad can be attached directly to the appropriate copper plane shown in the electrical schematic for the device, or alternatively, can be attached to a special heatsink structure designed into the PCB. This design optimizes the heat transfer from the integrated circuit (IC).

For additional information on the PowerPAD package and how to take advantage of its heat dissipating abilities, refer to Technical Brief, PowerPAD Thermally Enhanced Package, Texas Instruments Literature No. SLMA002 and Application Brief, PowerPAD Made Easy, Texas Instruments Literature No. SLMA004. Both documents are available at [www.ti.com](http://www.ti.com).

The exposed thermal pad dimensions for this package are shown in the following illustration.

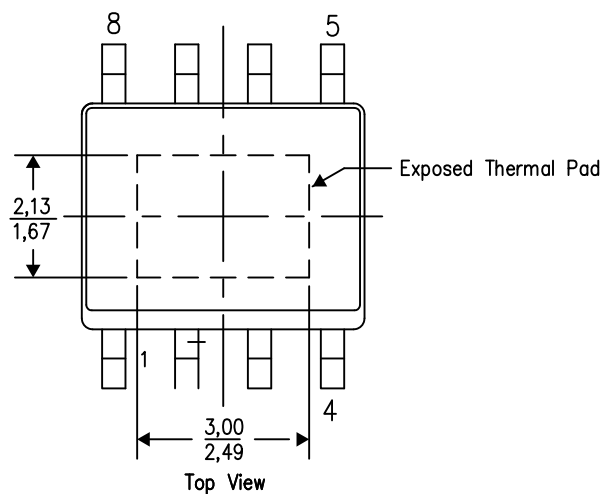

Exposed Thermal Pad Dimensions

4206322-5/L 05/12

NOTE: A. All linear dimensions are in millimeters

PowerPAD is a trademark of Texas Instruments

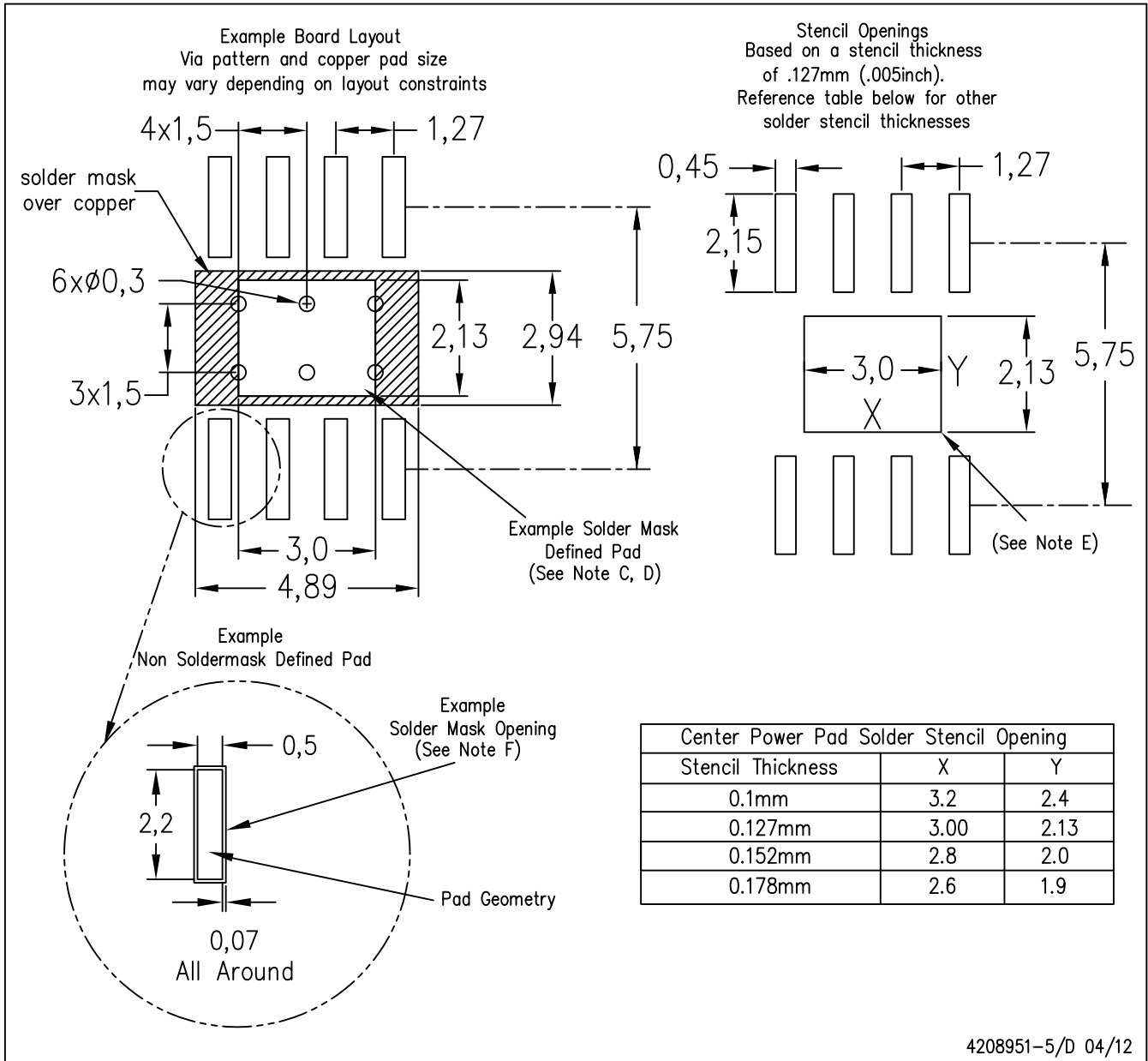

- NOTES:
- A. All linear dimensions are in millimeters.
  - B. This drawing is subject to change without notice.
  - C. Customers should place a note on the circuit board fabrication drawing not to alter the center solder mask defined pad.
  - D. This package is designed to be soldered to a thermal pad on the board. Refer to Technical Brief, PowerPad Thermally Enhanced Package, Texas Instruments Literature No. SLMA002, SLMA004, and also the Product Data Sheets for specific thermal information, via requirements, and recommended board layout. These documents are available at [www.ti.com](http://www.ti.com) <<http://www.ti.com>>. Publication IPC-7351 is recommended for alternate designs.
  - E. Laser cutting apertures with trapezoidal walls and also rounding corners will offer better paste release. Customers should contact their board assembly site for stencil design recommendations. Example stencil design based on a 50% volumetric metal load solder paste. Refer to IPC-7525 for other stencil recommendations.
  - F. Customers should contact their board fabrication site for solder mask tolerances between and around signal pads.

PowerPAD is a trademark of Texas Instruments.

## IMPORTANT NOTICE AND DISCLAIMER

TI PROVIDES TECHNICAL AND RELIABILITY DATA (INCLUDING DATASHEETS), DESIGN RESOURCES (INCLUDING REFERENCE DESIGNS), APPLICATION OR OTHER DESIGN ADVICE, WEB TOOLS, SAFETY INFORMATION, AND OTHER RESOURCES "AS IS" AND WITH ALL FAULTS, AND DISCLAIMS ALL WARRANTIES, EXPRESS AND IMPLIED, INCLUDING WITHOUT LIMITATION ANY IMPLIED WARRANTIES OF MERCHANTABILITY, FITNESS FOR A PARTICULAR PURPOSE OR NON-INFRINGEMENT OF THIRD PARTY INTELLECTUAL PROPERTY RIGHTS.

These resources are intended for skilled developers designing with TI products. You are solely responsible for (1) selecting the appropriate TI products for your application, (2) designing, validating and testing your application, and (3) ensuring your application meets applicable standards, and any other safety, security, or other requirements. These resources are subject to change without notice. TI grants you permission to use these resources only for development of an application that uses the TI products described in the resource. Other reproduction and display of these resources is prohibited. No license is granted to any other TI intellectual property right or to any third party intellectual property right. TI disclaims responsibility for, and you will fully indemnify TI and its representatives against, any claims, damages, costs, losses, and liabilities arising out of your use of these resources.

TI's products are provided subject to TI's Terms of Sale ([www.ti.com/legal/termsofsale.html](http://www.ti.com/legal/termsofsale.html)) or other applicable terms available either on [ti.com](http://ti.com) or provided in conjunction with such TI products. TI's provision of these resources does not expand or otherwise alter TI's applicable warranties or warranty disclaimers for TI products.

Mailing Address: Texas Instruments, Post Office Box 655303, Dallas, Texas 75265  
Copyright © 2019, Texas Instruments Incorporated